



CLINICAL GUIDELINES 2019

Using this Acrobat Document

This is a hyperlinked Acrobat document. Make sure your cursor is in the shape of a hand (select the hand tool in the menu bar). Move the cursor to the title of the guideline you want to choose. When the hand changes to a pointing finger, click and your screen will jump to that form. **TO PRINT:** Note the page number, choose your print command and enter the appropriate page(s) in the pages to print option area. Print the desired number of copies. To ensure the printed document is readable, select "none" in the scaling options field.

To return to this page from any other page in the document, click the YKHC logo at the top of the page. Black arrows click to next or previous page.

Contents

Emergency Department Guidelines	2
Skin and Soft Tissue Infection	3
Medevac Activation—Bethel to Anchorage	5
Medevac Activation – Village to Bethel.....	6
Intubation – Adult.....	7
Sepsis – Adult.....	8
Sepsis – Adult Medications.....	9
UTI – Adult.....	12
Pneumonia – Adult	13
Active Pulmonary TB for Patients ≥14 Years.....	14
Ischemic Stroke – Acute.....	15
Atrial Fibrillation / Atrial Flutter.....	16
Myocardial Infarction – Acute	17
Title 47 Hold	18
Acetaminophen Overdose	19
Rabies	22
Intoxicated ER Patient	23
Frostbite.....	24
Burn Evaluation and Treatment.....	25
First Trimester Vaginal Bleeding: Ectopic Pregnancy Diagnosis & Treatment of Non-Viable Early Pregnancy	26
Procalcitonin (PCT) in Adult Lower Respiratory Tract Infections.....	29
Emergency Department Protocols	30
Use of Consultants at YKHC	31
Pediatric Emergency Guidelines	32
(For Pediatric Critical Care Weight-Based Guide, see https://yk-health.org/wiki/File:Pediatric_critical_care_guide.pdf)	
Critical Care and Medevac Guide – Pediatric.....	33
Intubation – Pediatric.....	34
High-Flow Nasal Cannula (HFNC) — Pediatric.....	35
Sepsis – Pediatric.....	36
Seizure Evaluation – Pediatric.....	37
Seizure Treatment – Pediatric	38
Fever – Infants 0-90 days.....	39
Croup/Stridor: Evaluation & Treatment.....	40
Bronchiolitis / Wheezing – 3-24 Months	41
Pneumonia – Pediatric > 3 Months	42
Suspected Child Sexual Abuse Procedure.....	43
Head Injury/Concussion <18 Years	44
Amoxicillin Allergy Trials	45
Pediatric Outpatient Guidelines	46
UTI – Children 3 Months–5 Years.....	47
Otitis Media 3 Months–12 Years.....	48
Sinusitis > 5 Years	49
Attention Deficit Hyperactivity Disorder in Children	50
TB Evaluation & Treatment – Pediatric.....	51
Seizure Evaluation – Pediatric.....	52
Chronic Cough/Bronchiectasis – Pediatrics	53
Lead Evaluation – Pediatrics	54
Acute Cervical Lymphadenitis Evaluation & Treatment – Pediatrics	55
Amoxicillin Allergy Trials	56
Pediatric Neonatal Guidelines	57
Neonatal Resuscitation Summary	58
Newborn GBS & Infection Evaluation and Treatment.....	59
Jaundice – Neonatal Evaluation & Treatment	60
Neonatal Glucose Screening Evaluation and Treatment.....	61

Pediatric Protocols/Reference	62
Pediatric Induced Sputum Collection.....	63
Pediatric Hip Exam and Surveillance Protocol	64
Acute Concussion Evaluation (Ace) ED Version	65
Acute Concussion Evaluation (ACE) OP Version	67
ASAA Healthcare Provider Release and Return to Play Protocol ..	69
Use of Consultants at YKHC	71
OB Guidelines	72
First Trimester Vaginal Bleeding: Ectopic Pregnancy Diagnosis & Treatment of Non-Viable Early Pregnancy	73
Ectopic Pregnancy – Treatment	76
Labor Patient – Village	77
Preterm Labor – Screening and Prevention	78
Preterm Labor – Evaluation.....	79
Preterm Labor – Treatment	80
Gestational Diabetes	81
Group B Streptococcus (GBS) – Maternal	82
Molar Pregnancy	83
Anemia in Pregnancy	84
Anti-D Immune Globulin	85
Intrauterine Growth Restriction (IUGR)	86
Oligohydramnios.....	87
Post Dates Pregnancy.....	88
Induction of Labor.....	89
Intrahepatic Cholestasis of Pregnancy (IHCP).....	90
Chronic Hypertension in Pregnancy.....	91
Gestational Hypertension	92
Preterm Premature Rupture of Membranes	93
Vaginal Birth After Cesarean.....	94
OB Protocols	95
Antepartum Patient.....	96
Prenatal Care Guidelines	97
Use of Consultants at YKHC	98
Outpatient Guidelines	99
Skin and Soft Tissue Infection	100
Aspirin.....	102
Type 2 Diabetes.....	103
Congestive Heart Failure.....	106
Dyspepsia – H. Pylori	108
Hypertension	109
Myocardial Infarction (AMI) – Post Discharge Care	110
Breast Cancer Screening	111
UTI – Adult.....	112
Latent Tuberculosis Bacterial Infection (LTBI).....	113
Outpatient Protocols	114
Use of Consultants at YKHC	115
Colon Cancer Screening	116
Contraception – Quick Start	117
Chronic Pain – Narcotic Treatment Eligibility.....	118
Chronic Pain – Non Narcotics Treatment p.1	119
Chronic Pain – Reassessment & Follow-Up.....	123
Cervical Cancer Screening Protocol.....	124
Pre-Anesthesia Testing.....	125

CLINICAL GUIDELINES

2019

rev. 06-27-19

Emergency Department Guidelines

Skin and Soft Tissue Infection	3
Medevac Activation—Bethel to Anchorage	5
Medevac Activation – Village to Bethel.....	6
Intubation – Adult.....	7
Sepsis – Adult.....	8
Sepsis – Adult Medications.....	9
UTI – Adult.....	12
Pneumonia – Adult	13
Active Pulmonary TB for Patients \geq 14 Years.....	14
Ischemic Stroke – Acute	15
Atrial Fibrillation / Atrial Flutter.....	16
Myocardial Infarction – Acute	17
Title 47 Hold	18
Acetaminophen Overdose	19
Rabies	22
Intoxicated ER Patient	23
Frostbite.....	24
Burn Evaluation and Treatment.....	25
First Trimester Vaginal Bleeding: Ectopic Pregnancy	
Diagnosis & Treatment of Non-Viable Early Pregnancy.....	26
Procalcitonin (PCT) in Adult Lower Respiratory Tract Infections	29

Skin and Soft Tissue Infection, p.1

MSEC approved 07-12-17

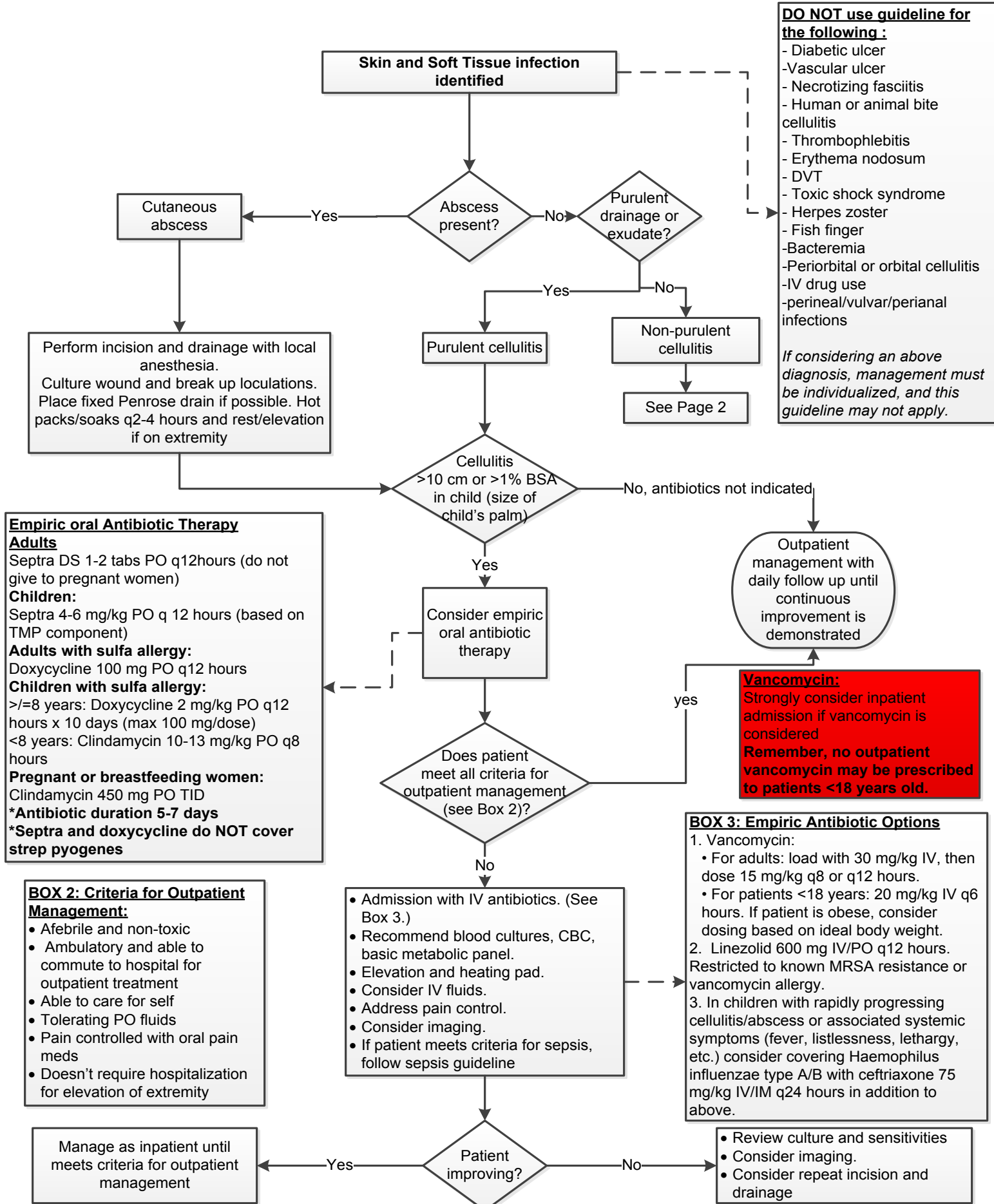

DO NOT use guideline for the following :

- Diabetic ulcer
- Vascular ulcer
- Necrotizing fasciitis
- Human or animal bite cellulitis
- Thrombophlebitis
- Erythema nodosum
- DVT
- Toxic shock syndrome
- Herpes zoster
- Fish finger
- Bacteremia
- Periorbital or orbital cellulitis
- IV drug use
- perineal/vulvar/perianal infections

If considering an above diagnosis, management must be individualized, and this guideline may not apply.

Empiric oral Antibiotic Therapy

Adults
Septra DS 1-2 tabs PO q12hours (do not give to pregnant women)

Children:
Septra 4-6 mg/kg PO q 12 hours (based on TMP component)

Adults with sulfa allergy:
Doxycycline 100 mg PO q12 hours

Children with sulfa allergy:
>=8 years: Doxycycline 2 mg/kg PO q12 hours x 10 days (max 100 mg/dose)
<8 years: Clindamycin 10-13 mg/kg PO q8 hours

Pregnant or breastfeeding women:
Clindamycin 450 mg PO TID

***Antibiotic duration 5-7 days**
***Septra and doxycycline do NOT cover strep pyogenes**

BOX 2: Criteria for Outpatient Management:

- Afebrile and non-toxic
- Ambulatory and able to commute to hospital for outpatient treatment
- Able to care for self
- Tolerating PO fluids
- Pain controlled with oral pain meds
- Doesn't require hospitalization for elevation of extremity

- Admission with IV antibiotics. (See Box 3.)
- Recommend blood cultures, CBC, basic metabolic panel.
- Elevation and heating pad.
- Consider IV fluids.
- Address pain control.
- Consider imaging.
- If patient meets criteria for sepsis, follow sepsis guideline

BOX 3: Empiric Antibiotic Options

1. Vancomycin:
 - For adults: load with 30 mg/kg IV, then dose 15 mg/kg q8 or q12 hours.
 - For patients <18 years: 20 mg/kg IV q6 hours. If patient is obese, consider dosing based on ideal body weight.
2. Linezolid 600 mg IV/PO q12 hours. Restricted to known MRSA resistance or vancomycin allergy.
3. In children with rapidly progressing cellulitis/abscess or associated systemic symptoms (fever, listlessness, lethargy, etc.) consider covering Haemophilus influenzae type A/B with ceftriaxone 75 mg/kg IV/IM q24 hours in addition to above.

Vancomycin:
Strongly consider inpatient admission if vancomycin is considered
Remember, no outpatient vancomycin may be prescribed to patients <18 years old.

Manage as inpatient until meets criteria for outpatient management

- Review culture and sensitivities
- Consider imaging.
- Consider repeat incision and drainage

Skin and Soft Tissue Infection, p.2

MSEC approved 07-12-17

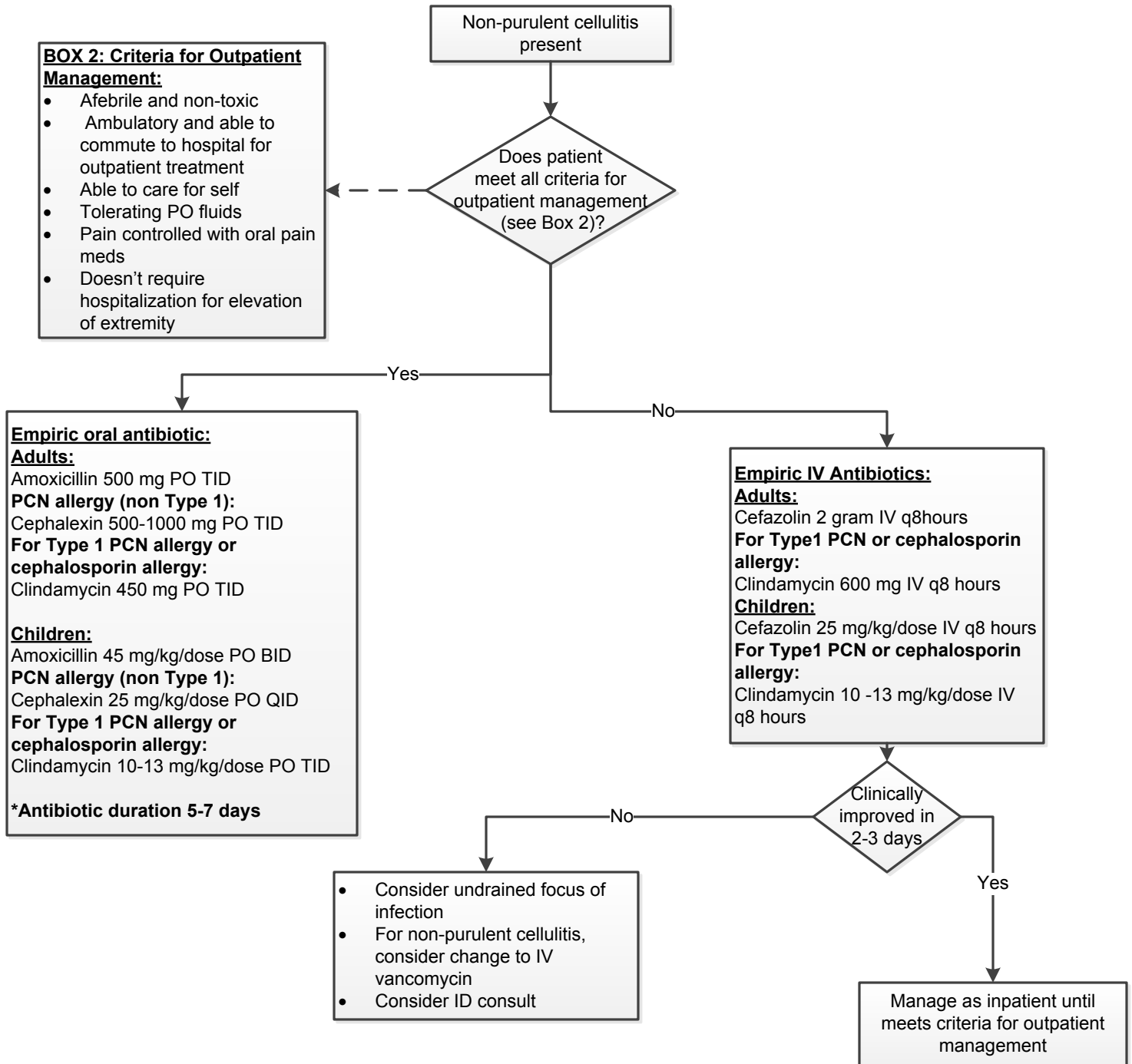

Medevac Activation—Bethel to Anchorage

MSEC approved 06/22/11

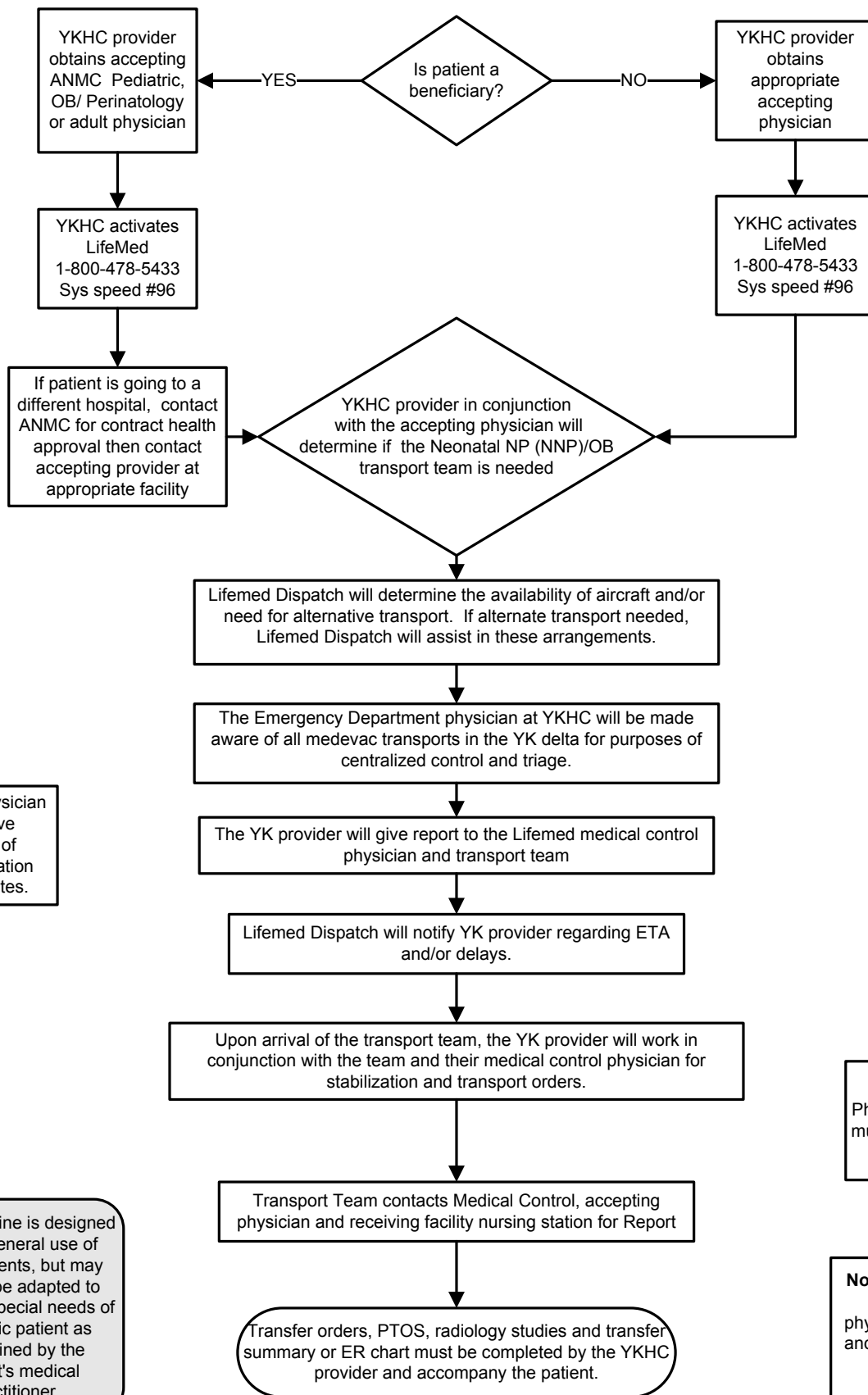

Note: YKHC physician should receive confirmation of medevac activation within 30 minutes.

Note: Accepting Physician for Elmendorf must either be a Military or VA Physician

This guideline is designed for the general use of most patients, but may need to be adapted to meet the special needs of a specific patient as determined by the patient's medical practitioner.

Note: ER to ER transport you must notify ER physician of receiving site and put their name on the PTOS as receiving physician

Medevac Activation – Village to Bethel

MSEC approved 06/22/11

Village to Bethel Collaboration

Village Health Aide collaborates with provider (RMT provider, Night Float provider, or ER Physician) to make decision if medevac is indicated

Activation of Medevac

Activating provider calls LifeMed Dispatch with patient's name, DOB, village, and diagnosis

LifeMed Dispatch 1-800-478-5433

NOTE: In the event of multiple medevacs, the ER Physician in collaboration with LifeMed must make decision regarding priority

Transfer Care to ER Physician

Activating provider completes PTO and takes PTO and provider notes to ER Physician who assumes care.

Centralized medical control is **critical**. If for any reason, the ER Physician requests an activating provider maintain control, the ER Physician must be kept up to date on patient and medevac status

Bethel-Village Collaboration

ER Physician calls village Health Aide to get updates and continues to keep records on the RMT Form for Village to Bethel Medevacs

In the event that a medevac is cancelled (patient deemed stable to come in on scheduled flight) LifeMed dispatch must be notified by the ER Physician immediately.

LifeMed Dispatch

1. LifeMed Dispatch notifies Grant Aviation/Pilot/LifeMed *If LifeMed cannot launch (weather, runway lights) dispatch notifies ER Physician. Pilot will continue to check weather.*
2. ER clerk faxes PTO, health summary, notes to Bethel LifeMed crew quarters
3. LifeMed crew contacts Village Health Aide and ER Physician for additional information prior to flying
4. If there is a prolonged delay (weather) it is crucial that LifeMed crew contacts the ER Physician and Health Aide prior to flying
5. In extenuating circumstances patient may need direct transport to Anchorage from village. After obtaining an accepting physician in Anchorage, YK MD will work with LifeMed for transport logistics.

Consider Ramp Transfer Direct to Anchorage under these circumstances:

1. Obvious need for acute surgical intervention
2. Hemodynamically stable intubated patients
3. Hemodynamically stable acute MI patients
4. Other extenuating circumstances.

LifeMed launches

1. Once in village LifeMed calls ER physician to report, establish treatment plan and gives Estimated Time of Arrival (ETA) to Bethel to ER Physician
2. ER Physician keeps Charge Nurse informed of patient status/ETA of Medevac

Arrival in Bethel

1. Patient care is transferred to ER staff and LifeMed gives report to YK MD and nursing staff
2. Completed transport chart placed in patient's ER chart prior to departure of LifeMed staff*

*Under extenuating circumstances, the LifeMed team may be unable to complete the transport chart prior to departure from ED

This guideline is designed for the general use of most patients, but may need to be adapted to meet the special needs of a specific patient as determined by the patient's medical practitioner.

Intubation – Adult

MSEC approved 06/22/11

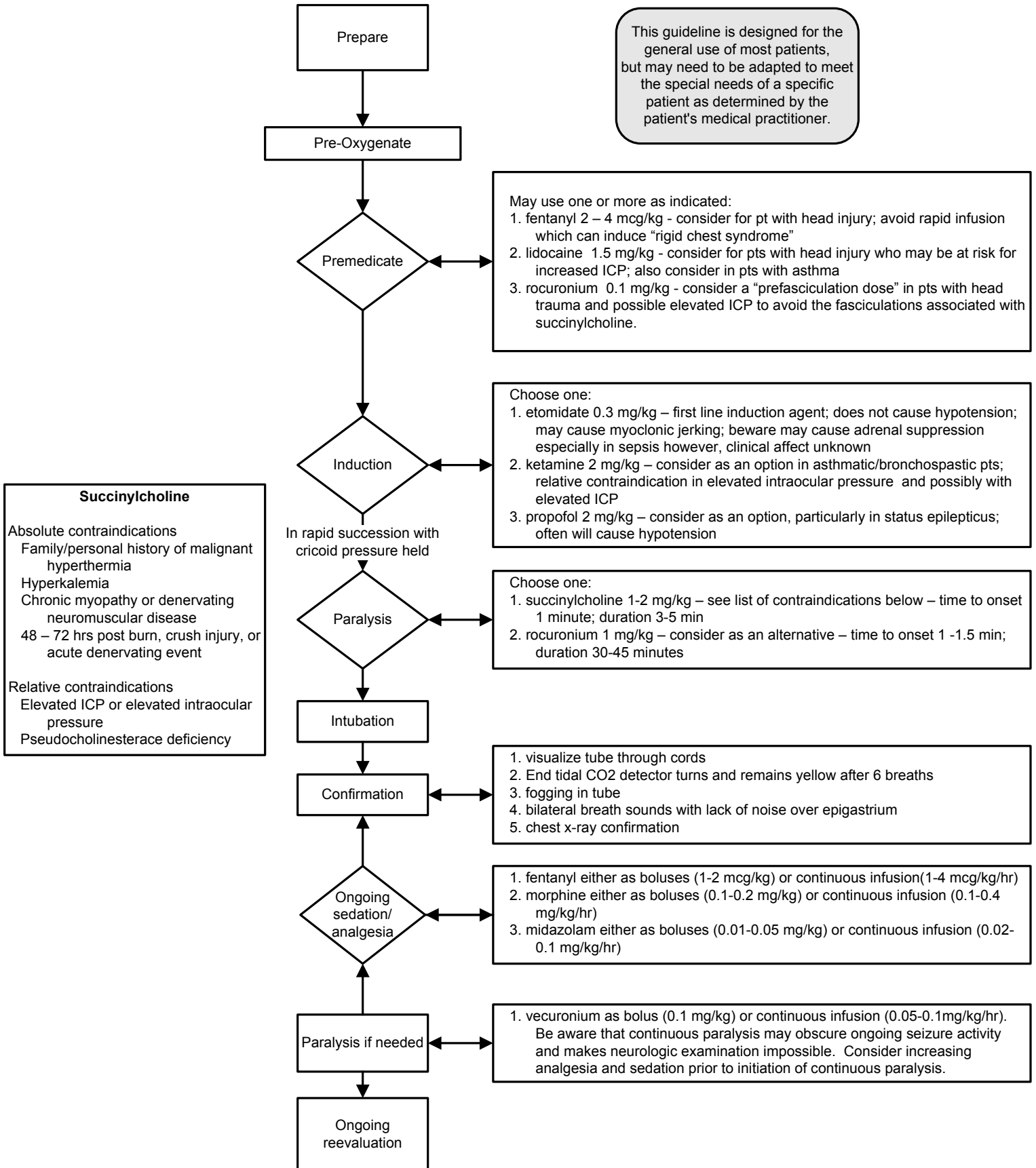

Sepsis – Adult

MSEC approved 7/12/17

qSOFA – 2 or more of the following:
 RR > 22
 altered mental status (GCS<15)
 SBP < 100

SEPSIS 3 & ACEP NOTES

4-6L of total IVF is often needed during the first 6 hrs, after 2L of NS consider switch to LR, remember that if the patient fails to respond after the first 2-3 L, pressors should be considered.

In pts with concern for fluid overload (hx CHF, renal or liver failure) or complications from fluid resuscitation, use less total fluid or smaller boluses with more frequent reassessment of volume status, but **DO NOT DELAY FLUID AND VASOPRESSOR TREATMENT**

Persistence of elevated lactate, even in the absence of hypotension, is associated with poor outcomes

CRP and procalcitonin may be elevated but can not effectively guide ED sepsis care — **CHECK (and RECHECK) LACTATE**

in the absence of extenuating circumstances (MI, severe hypoxia, acute blood loss, etc) transfusion is no longer recommended unless Hgb < 7

Consider insulin if 2 consecutive blood glucose levels are > 180

Sodium bicarbonate is not recommended to improve hemodynamics or decrease vasopressor requirements in pts with hypoperfusion induced lactic acidemia with pH >= 7.15

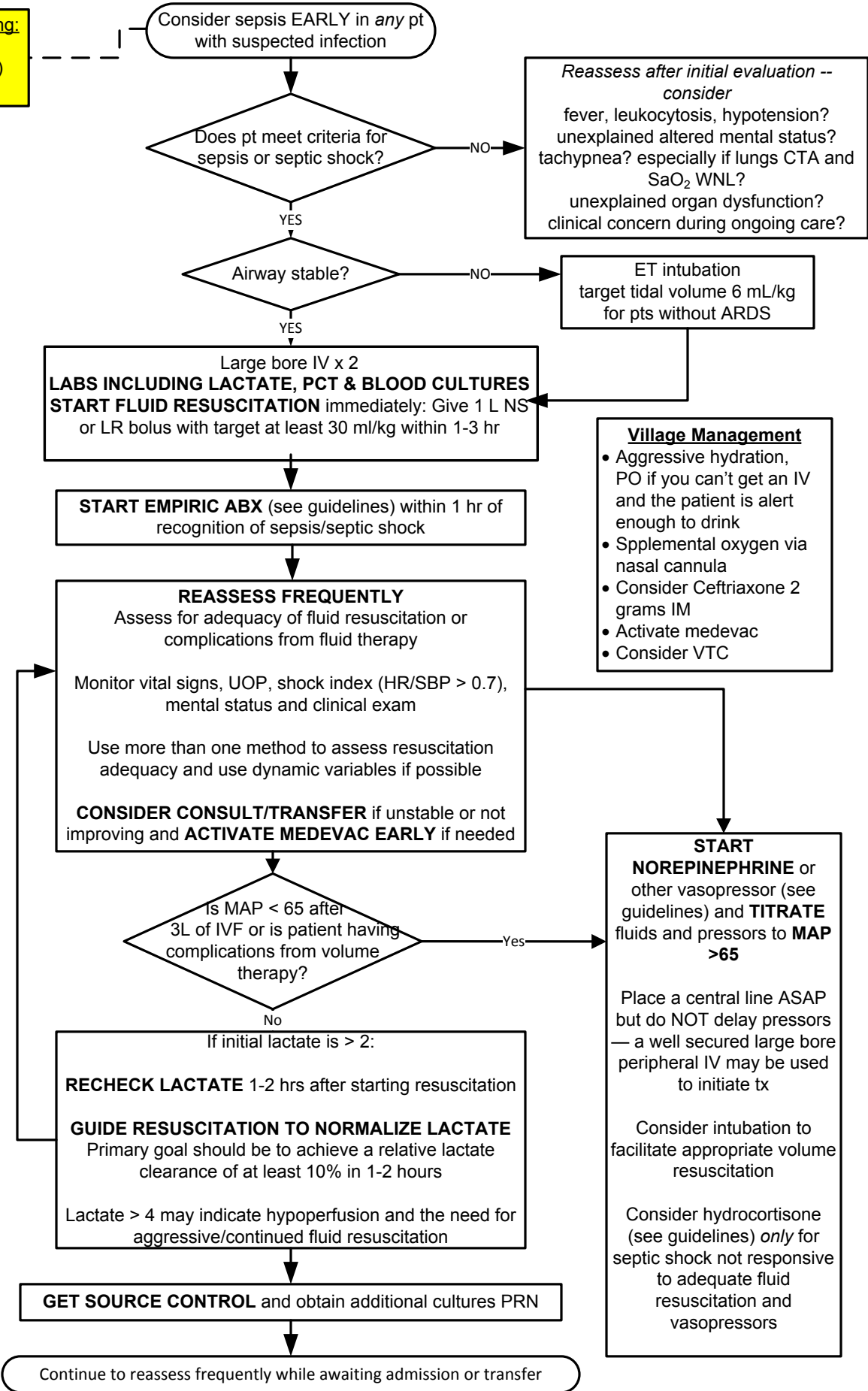

Sepsis – Adult Medications p. 1

MSEC approved 07/12/17

EMPIRIC ANTIBIOTIC RECOMMENDATIONS BY SOURCE OF INFECTION

Source of infection	Medication	Dose	Maximum Dose
<i>*If possible, 1st dose of antibiotics should be administered as a 30 min infusion to reduce time to therapeutic concentration*</i>			
unknown	vancomycin ¹	25-30 mg/kg loading dose THEN 20mg/kg Q8-12 hrs	2 grams
	OR		
	linezolid	600 mg IV Q12 hrs	600 mg
	AND		
	piperacillin-tazobactam ²	4.5 grams IV Q8 hrs	4.5 grams
	OR		
	cefepime	2 grams IV Q8 hrs if in shock	2 grams
	AND		
	gentamicin or tobramycin ³	7 mg/kg IV Q24 hrs	Consult pharm
	OR		
levofloxacin	750 mg IV Q24 hrs	750 mg	
community acquired pneumonia	ceftriaxone	1 gram IV Q24 hrs (2 gm if > 80 kg)	2 grams
	OR		
	ampicillin-sulbactam	3 gm Q6 hrs	
	AND		
	levofloxacin	750 mg IV Q24 hrs	750 mg
	OR		
	azithromycin	500 mg PO/IV Q24 hrs	500 mg
<i>if at risk for aspiration CONSIDER</i>			
Metronidazole	500 mg IV Q8hrs	depends	
hospital acquired pneumonia OR high risk for MDR organisms	vancomycin ¹	25-30 mg/kg loading dose THEN 20mg/kg Q8-12 hrs	2 grams
	OR		
	linezolid	600 mg IV Q12 hrs	600 mg
	AND		
	piperacillin-tazobactam ²	4.5 grams IV Q6 hrs	4.5 grams
	OR		
	cefepime	2 grams IV Q8 hrs	2 grams
	AND		
	levofloxacin	750 mg IV Q24 hrs	750 mg
	OR		
gentamicin or tobramycin ³	7 mg/kg IV Q24 hrs	Consult pharm	
meningitis	dexamethasone	10 mg IV PRIOR TO ABX	
	AND		
	vancomycin ¹	25-30 mg/kg loading dose THEN 20mg/kg Q8-12 hrs	2 grams
	AND		
	ceftriaxone	2 grams IV Q12 hrs	2 grams
<i>if > 50 y/o ADD</i>			
ampicillin	2 grams IV Q6 hrs	2 grams	

Sepsis – Adult Medications p. 2

MSEC approved 07/12/17

urinary tract	<table border="1" style="width: 100%; border-collapse: collapse;"> <tr> <td style="width: 30%;">ceftriaxone</td> <td style="width: 40%;">1 gm IV Q24 hrs (2 gm if > 80 kg)</td> <td style="width: 30%;">2 grams</td> </tr> <tr> <td colspan="3" style="text-align: center;"><i>AND consider</i></td> </tr> <tr> <td>gentamicin</td> <td>7 mg/kg IV Q24 hrs</td> <td>Consult pharm</td> </tr> <tr> <td colspan="3" style="text-align: center;">OR</td> </tr> <tr> <td>levofloxacin</td> <td>750 mg IV Q24 hrs</td> <td>750 mg</td> </tr> <tr> <td colspan="3" style="text-align: center;"><i>if urological interventions or MDR risk factors CONSIDER</i></td> </tr> <tr> <td>piperacillin-tazobactam²</td> <td>3.375 grams IV Q6 hrs</td> <td>4.5 grams</td> </tr> <tr> <td colspan="3" style="text-align: center;">OR</td> </tr> <tr> <td>cefepime</td> <td>1 gram IV Q6 hrs</td> <td>2 grams</td> </tr> <tr> <td colspan="3" style="text-align: center;"><i>if ESBL add</i></td> </tr> <tr> <td>Meropenem</td> <td>500 mg IV q8hrs</td> <td>1 gram</td> </tr> </table>	ceftriaxone	1 gm IV Q24 hrs (2 gm if > 80 kg)	2 grams	<i>AND consider</i>			gentamicin	7 mg/kg IV Q24 hrs	Consult pharm	OR			levofloxacin	750 mg IV Q24 hrs	750 mg	<i>if urological interventions or MDR risk factors CONSIDER</i>			piperacillin-tazobactam ²	3.375 grams IV Q6 hrs	4.5 grams	OR			cefepime	1 gram IV Q6 hrs	2 grams	<i>if ESBL add</i>			Meropenem	500 mg IV q8hrs	1 gram															
ceftriaxone	1 gm IV Q24 hrs (2 gm if > 80 kg)	2 grams																																															
<i>AND consider</i>																																																	
gentamicin	7 mg/kg IV Q24 hrs	Consult pharm																																															
OR																																																	
levofloxacin	750 mg IV Q24 hrs	750 mg																																															
<i>if urological interventions or MDR risk factors CONSIDER</i>																																																	
piperacillin-tazobactam ²	3.375 grams IV Q6 hrs	4.5 grams																																															
OR																																																	
cefepime	1 gram IV Q6 hrs	2 grams																																															
<i>if ESBL add</i>																																																	
Meropenem	500 mg IV q8hrs	1 gram																																															
Intra-abdominal/pelvic	<table border="1" style="width: 100%; border-collapse: collapse;"> <tr> <td style="width: 30%;">piperacillin-tazobactam²</td> <td style="width: 40%;">3.375 grams IV Q6 hrs</td> <td style="width: 30%;">4.5 grams</td> </tr> <tr> <td colspan="3" style="text-align: center;">OR</td> </tr> <tr> <td>cefepime</td> <td>1 gram IV Q6 hrs</td> <td>2 grams</td> </tr> <tr> <td colspan="3" style="text-align: center;">AND</td> </tr> <tr> <td>metronidazole</td> <td>500 mg IV Q6 hrs</td> <td>500 mg</td> </tr> <tr> <td colspan="3" style="text-align: center;">OR</td> </tr> <tr> <td>ciprofloxacin</td> <td>400 mg IV Q12 hrs</td> <td>400 mg</td> </tr> <tr> <td colspan="3" style="text-align: center;">AND</td> </tr> <tr> <td>metronidazole</td> <td>500 mg IV Q8 hrs</td> <td>500 mg</td> </tr> </table>	piperacillin-tazobactam ²	3.375 grams IV Q6 hrs	4.5 grams	OR			cefepime	1 gram IV Q6 hrs	2 grams	AND			metronidazole	500 mg IV Q6 hrs	500 mg	OR			ciprofloxacin	400 mg IV Q12 hrs	400 mg	AND			metronidazole	500 mg IV Q8 hrs	500 mg																					
piperacillin-tazobactam ²	3.375 grams IV Q6 hrs	4.5 grams																																															
OR																																																	
cefepime	1 gram IV Q6 hrs	2 grams																																															
AND																																																	
metronidazole	500 mg IV Q6 hrs	500 mg																																															
OR																																																	
ciprofloxacin	400 mg IV Q12 hrs	400 mg																																															
AND																																																	
metronidazole	500 mg IV Q8 hrs	500 mg																																															
skin and soft tissue/necrotizing infections	<table border="1" style="width: 100%; border-collapse: collapse;"> <tr> <td colspan="3" style="text-align: center;"><i>if PURULENT</i></td> </tr> <tr> <td style="width: 30%;">vancomycin¹</td> <td style="width: 40%;">25-30 mg/kg loading dose THEN 20mg/kg Q8-12 hrs</td> <td style="width: 30%;">2 grams</td> </tr> <tr> <td colspan="3" style="text-align: center;"><i>if NONPURULENT</i></td> </tr> <tr> <td>cefazolin</td> <td>2 grams IV Q8 hrs</td> <td>2 grams</td> </tr> <tr> <td colspan="3" style="text-align: center;">OR</td> </tr> <tr> <td>ceftriaxone</td> <td>1-2 grams IV Q24 hrs</td> <td>2 grams</td> </tr> <tr> <td colspan="3" style="text-align: center;">OR</td> </tr> <tr> <td>ampicillin-sulbactam</td> <td>3 grams Q6 hrs</td> <td>3 grams</td> </tr> <tr> <td colspan="3" style="text-align: center;"><i>if NECROTIZING ADD</i></td> </tr> <tr> <td>piperacillin-tazobactam²</td> <td>3.375 grams IV Q6 hrs</td> <td>4.5 grams</td> </tr> <tr> <td colspan="3" style="text-align: center;">AND</td> </tr> <tr> <td>clindamycin</td> <td>900 mg IV Q8 hrs</td> <td>900 mg</td> </tr> <tr> <td colspan="3" style="text-align: center;">OR</td> </tr> <tr> <td>ceftriaxone</td> <td>2 grams IV Q12 hrs</td> <td>2 grams</td> </tr> <tr> <td colspan="3" style="text-align: center;">AND</td> </tr> <tr> <td>metronidazole</td> <td>500 mg IV Q6 hrs</td> <td>500 mg</td> </tr> </table>	<i>if PURULENT</i>			vancomycin ¹	25-30 mg/kg loading dose THEN 20mg/kg Q8-12 hrs	2 grams	<i>if NONPURULENT</i>			cefazolin	2 grams IV Q8 hrs	2 grams	OR			ceftriaxone	1-2 grams IV Q24 hrs	2 grams	OR			ampicillin-sulbactam	3 grams Q6 hrs	3 grams	<i>if NECROTIZING ADD</i>			piperacillin-tazobactam ²	3.375 grams IV Q6 hrs	4.5 grams	AND			clindamycin	900 mg IV Q8 hrs	900 mg	OR			ceftriaxone	2 grams IV Q12 hrs	2 grams	AND			metronidazole	500 mg IV Q6 hrs	500 mg
<i>if PURULENT</i>																																																	
vancomycin ¹	25-30 mg/kg loading dose THEN 20mg/kg Q8-12 hrs	2 grams																																															
<i>if NONPURULENT</i>																																																	
cefazolin	2 grams IV Q8 hrs	2 grams																																															
OR																																																	
ceftriaxone	1-2 grams IV Q24 hrs	2 grams																																															
OR																																																	
ampicillin-sulbactam	3 grams Q6 hrs	3 grams																																															
<i>if NECROTIZING ADD</i>																																																	
piperacillin-tazobactam ²	3.375 grams IV Q6 hrs	4.5 grams																																															
AND																																																	
clindamycin	900 mg IV Q8 hrs	900 mg																																															
OR																																																	
ceftriaxone	2 grams IV Q12 hrs	2 grams																																															
AND																																																	
metronidazole	500 mg IV Q6 hrs	500 mg																																															
neutropenic cancer patients (ANC < 500)	<table border="1" style="width: 100%; border-collapse: collapse;"> <tr> <td style="width: 30%;">piperacillin-tazobactam²</td> <td style="width: 40%;">4.5 grams IV Q6-8 hrs</td> <td style="width: 30%;">4.5 grams</td> </tr> <tr> <td colspan="3" style="text-align: center;">OR</td> </tr> <tr> <td>cefepime</td> <td>1 gram IV Q6 hrs</td> <td>2 grams</td> </tr> <tr> <td colspan="3" style="text-align: center;">AND</td> </tr> <tr> <td>vancomycin¹</td> <td>25-30 mg/kg loading dose THEN 20mg/kg Q8-12 hrs</td> <td>2 grams</td> </tr> <tr> <td colspan="3" style="text-align: center;"><i>is suspected/confirmed HSV or VZV CONSIDER</i></td> </tr> <tr> <td>acyclovir</td> <td>10 mg/kg Q8 hrs</td> <td>Consult pharm</td> </tr> </table>	piperacillin-tazobactam ²	4.5 grams IV Q6-8 hrs	4.5 grams	OR			cefepime	1 gram IV Q6 hrs	2 grams	AND			vancomycin ¹	25-30 mg/kg loading dose THEN 20mg/kg Q8-12 hrs	2 grams	<i>is suspected/confirmed HSV or VZV CONSIDER</i>			acyclovir	10 mg/kg Q8 hrs	Consult pharm																											
piperacillin-tazobactam ²	4.5 grams IV Q6-8 hrs	4.5 grams																																															
OR																																																	
cefepime	1 gram IV Q6 hrs	2 grams																																															
AND																																																	
vancomycin ¹	25-30 mg/kg loading dose THEN 20mg/kg Q8-12 hrs	2 grams																																															
<i>is suspected/confirmed HSV or VZV CONSIDER</i>																																																	
acyclovir	10 mg/kg Q8 hrs	Consult pharm																																															

Sepsis – Adult Medications p. 3

MSEC approved 07/12/17

- ¹ linezolid may be substituted for vancomycin in patients with relative contraindication to vancomycin use or high risk for AKI
² gentamicin and tobramycin dosing based on ideal body weight
³ may substitute ampicillin-sulbactam 3 gm IV Q6 hrs for piperacillin-tazobactam when pseudomonas is not of concern

VASOPRESSORS

medication	dose	notes
<i>*ALL vasoactive medications should be infused via central line with the exception of dopamine, which can be infused via a peripheral IV at rates less than 10 mcg/kg/min*</i>		
norepinephrine	8-12 mcg/min IV initial infusion rate	1 st line vasopressor of choice in sepsis
epinephrine	1-10 mcg/min initially, titrated to effect	may be added to or used in place of norepinephrine to maintain adequate BP
dopamine	2-20 mcg/kg/min	2 nd line option in highly select patients as it causes more tachycardia
phenylephrine	100-180 mcg/min IV initial infusion until stabilized, titrate to goal of 60-200 mcg/min (max dose range 80-360 mcg/min)	can be used as salvage therapy for refractive hypotension associated with tachycardia
vasopressin	0.03-0.04 units/min	may be added to norepinephrine to increase MAP or decrease norepinephrine dose – DO NOT use as a single agent
dobutamine	2-20 mcg/kg/min IV infusion	may be used for inotropic support in the presence of severe myocardial dysfunction or hypoperfusion with depressed cardiac output

CORTICOSTEROIDS

Corticosteroids should NOT be administered for the treatment of sepsis in the absence of shock. Steroids are beneficial in those experiencing adrenal insufficiency in the presence of septic shock, however ACTH testing is not routinely recommended in adult patients. If hemodynamic stability is not achieved after adequate fluid resuscitation and vasopressor therapy, the use of IV hydrocortisone alone at a dose of 200 mg/day can be considered regardless of AI status. Hydrocortisone should be tapered when vasopressors are no longer required.

UTI – Adult

MSEC approved 10/15/18

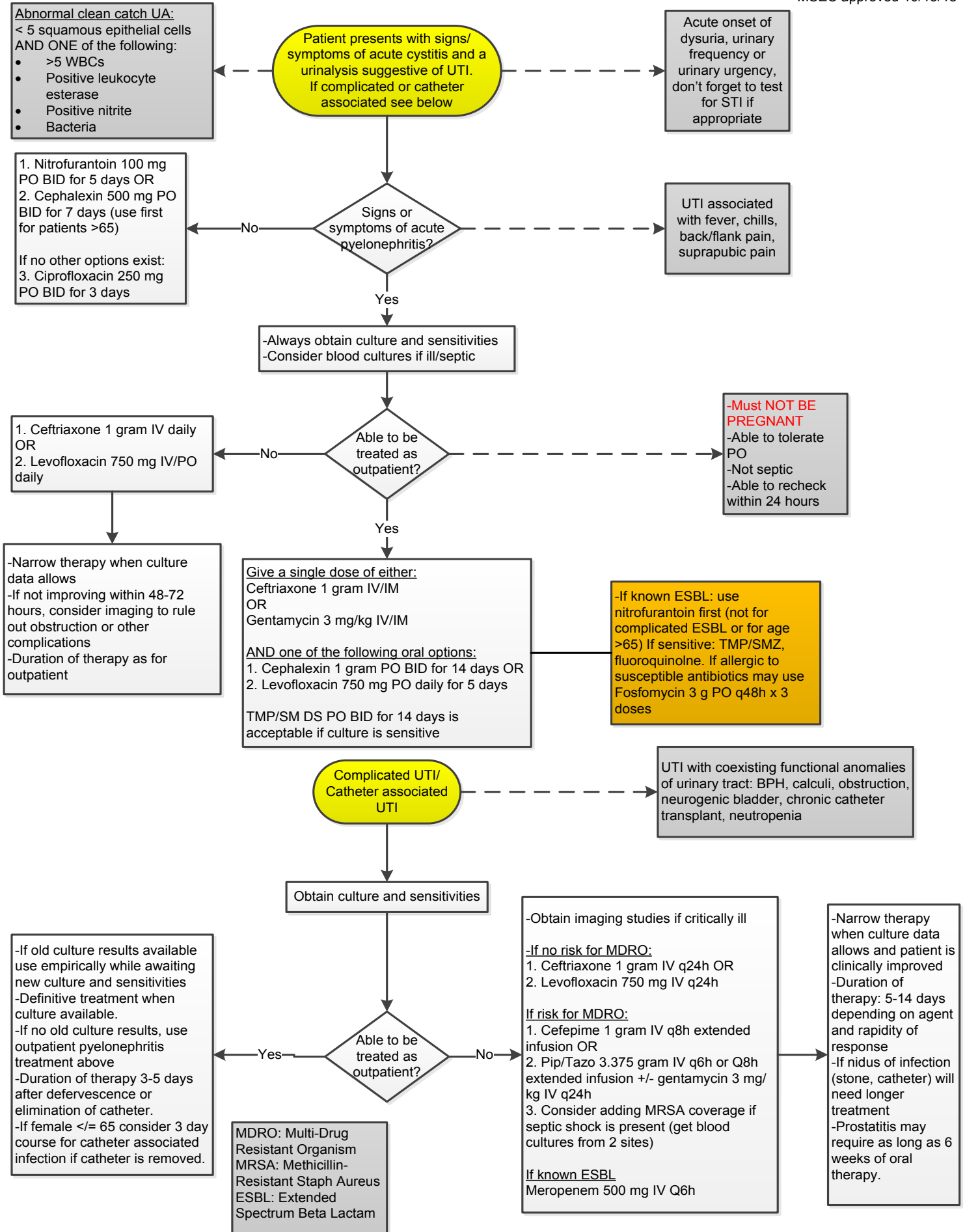

Pneumonia – Adult

MSEC approved 09/21/18

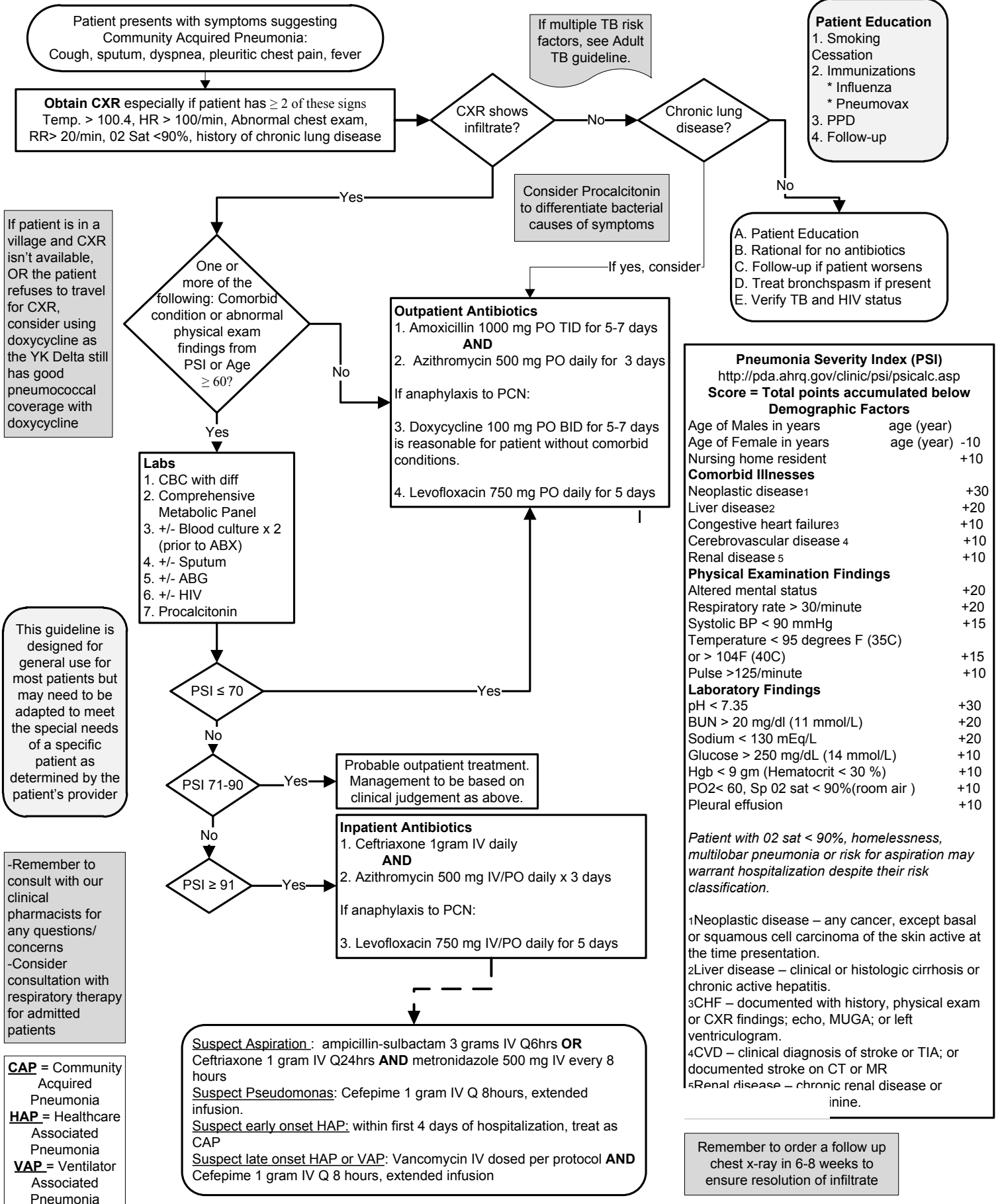

Active Pulmonary TB for Patients ≥14 Years

MSEC approved 04-13-16

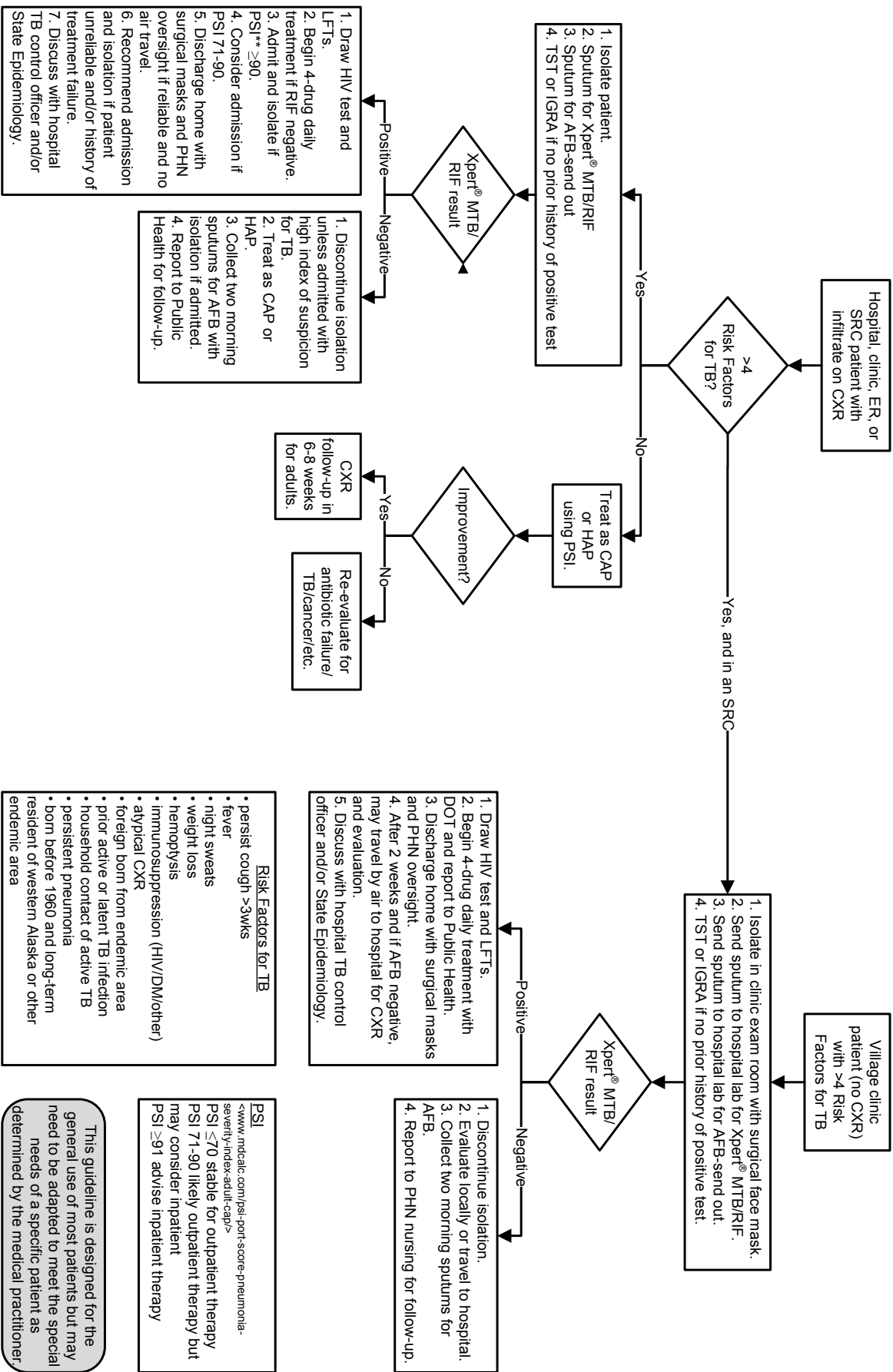

Abbreviations: AFB-acid fast bacilli; CA-cancer; CAP-community acquired pneumonia; CXR-chest x-ray; DM-diabetes mellitus; DOT-directed observational therapy; ER-emergency room; LFTs-liver function tests; HAP-healthcare associated pneumonia; HIV-human immunodeficiency virus; IGRA-interferon gamma release assay; PHN-public health nurse; PSI-pneumonia severity index; SRC-subregional clinic; RIF- rifampin resistance; TB-tuberculosis; TST-tuberculin skin test

Ischemic Stroke – Acute

MSEC approved 06/22/11

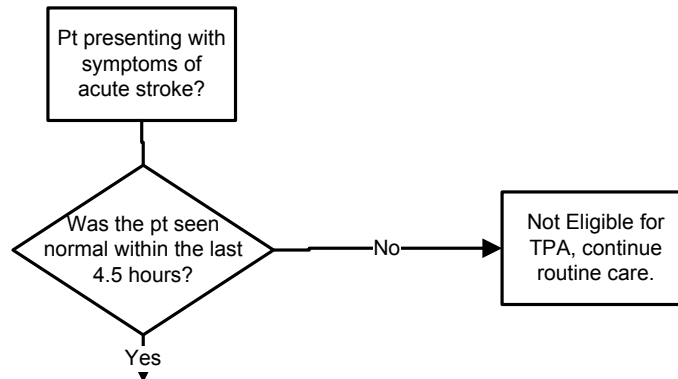

This guideline is designated for the general use of most patients, but may need to be adapted to meet the special needs of a specific patient as determined by the patient's medical practitioner

Exclusion criteria

- Any hemorrhage on CT
- BP > 185/110
- NIHSS* < 4 or rapidly improving exam
- Hx suggestive of SAH even with normal CT
- INR > 1.7 or on heparin with elevated PTT
- Platelets < 100,000
- Seizure at onset of symptoms
- History of any of the following:
 - intracranial hemorrhage
 - intracranial Neoplasm or AVM
 - major surgery <14 days
 - head trauma in last 3 months
 - arterial puncture at non-compressible site < 7 days
 - GI or GU hemorrhage <21 days
 - LP in last 24 hrs
- Glucose <50 or >400 (may continue if symptoms persist after glucose corrected)
- Presumed septic emboli

Additional 3-4.5 hr Exclusion Criteria

- age >80 yrs old
- NIHSS* >25
- Prior stroke + DM
- anticoagulation regardless of IHR

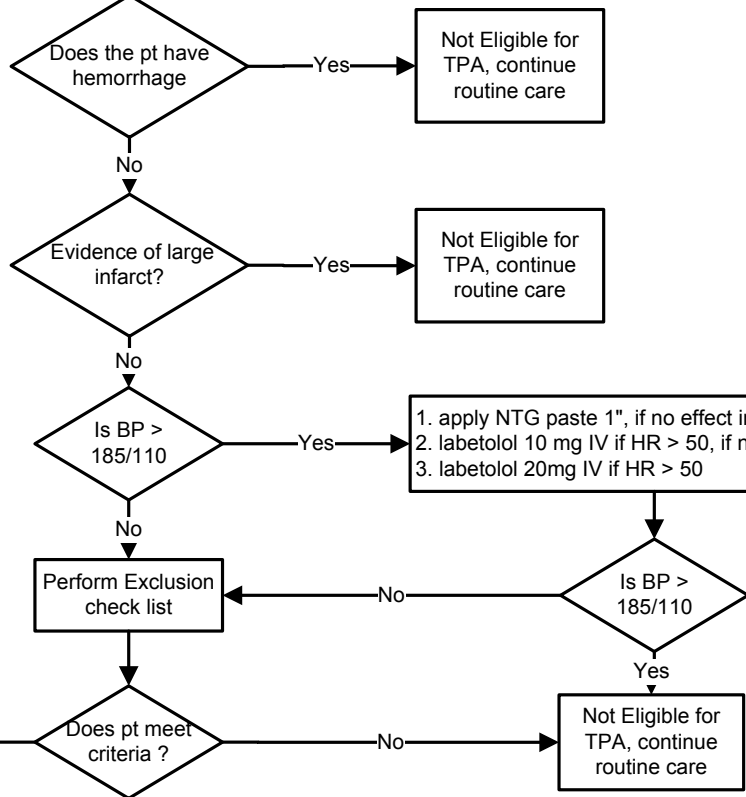

Ref: 1). FCASS 3 trial. Lancet Newrol 2009; 8: 1095. 2). Uptodate ,www.uptodate.com/contents/reperfusion-therapy-for-acute-stroke>
*NIH Stroke Scale (NIHSS) calculator: <www.mdcalc.com/nih-stroke-scale-score-nihss>

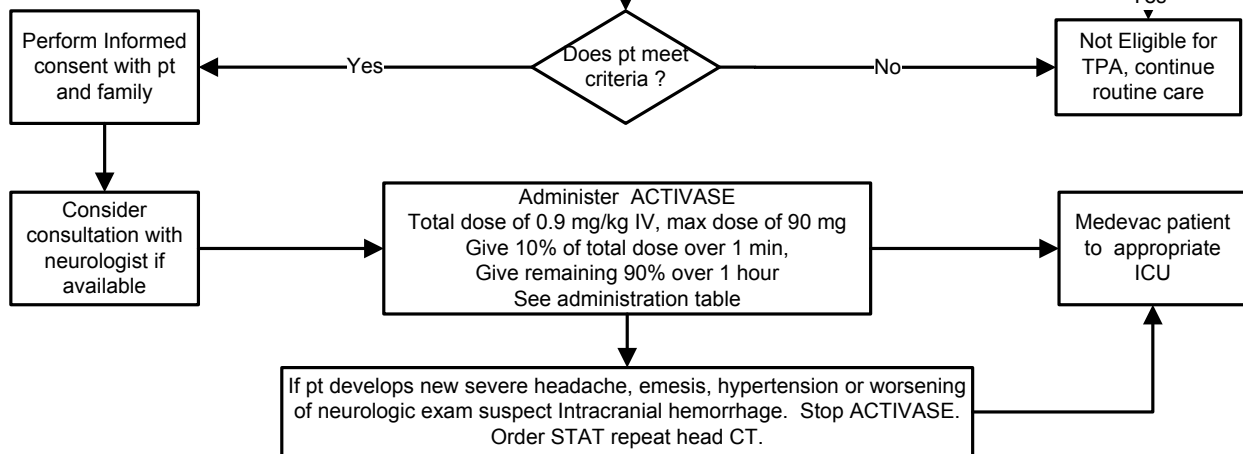

Atrial Fibrillation / Atrial Flutter

MSEC approved 06/22/11

Consult ANMC Cardiology to confirm indication, consider alternative, and need for antiarrhythmic drugs prior to procedure

Ensure that patient had no solid food x 6 hours and no clear liquids x 3 hours

1. Obtain Chem 8 and Magnesium, CBC, PT/PTT
(Patient should have no significantly abnormal lytes, decompensated COPD or active infections)
2. Digoxin Level – if applicable
(Procedure may be done on patient with therapeutic dig level and no evidence of toxicity)

Obtain consent for procedure

Anesthesia present with full ACLS setup, including meds and temporary pacer. Anesthesia obtains consent for sedation/anesthesia

Shave off significant hair

Position conductive pads or paddles with adequate gel (pads preferred)

Position posteriorly below left scapula and anteriorly just to right of sternum and over right upper parasternal to left cardiac apex

Set defibrillator to SYNCHRONIZED shock. Verify that device is correctly synchronizing on the QRS complex.

Rare complication –V-tach or V-Fib usually occurs when shock delivered in UNSYNCHRONIZED MODE. Brief ventricular ectopy occurring post shock is of no clinical significance. If sustained v-tach or v-fib delivery and UNSYNCHRONIZED SHOCK AT 360 J.

Administer anesthesia/sedation

Deliver synchronized shock at 50 J

Try to deliver all shocks during expiration

Restoration of sinus rhythm?

RESYNCHRONIZE Repeat shock at 100 J

Restoration Of sinus Rhythm?

RESYNCHRONIZE Repeat shock at 100 J, consider increase to 200 J

Restoration of sinus rhythm?

Move anterior pad to left parasternal, RESYNCHRONIZE and repeat shock at 360 J
*A total of 4 shocks will be given before the procedure is declared unsuccessful

Patient with a new or changed prescription for an antiarrhythmic drug?

Monitor pt. for 48hrs and consult ANMC cardiology for further future treatment plan

Pt. to be observed and discharged per post-anesthesia criteria

Persistent bradycardia with hypotension?

Refer to ACLS protocol

Atropine 0.5 mg IV x 2 if needed

Continued bradycardia or hypotension?

Dopamine 5-10 µg/kg per minute for vasopressor dose

Severe Bradycardia (<20 bpm) or asystole >10 sec?

Set defibrillator to PACE mode

Begin with 80 mA And increase every 5 sec until Ventricular capture obtained

This guideline is designed for general use for most patients but may need to be adapted to meet the special needs of a specific patient as determined by the patient's provider

Myocardial Infarction – Acute

MSEC approved 06/22/11

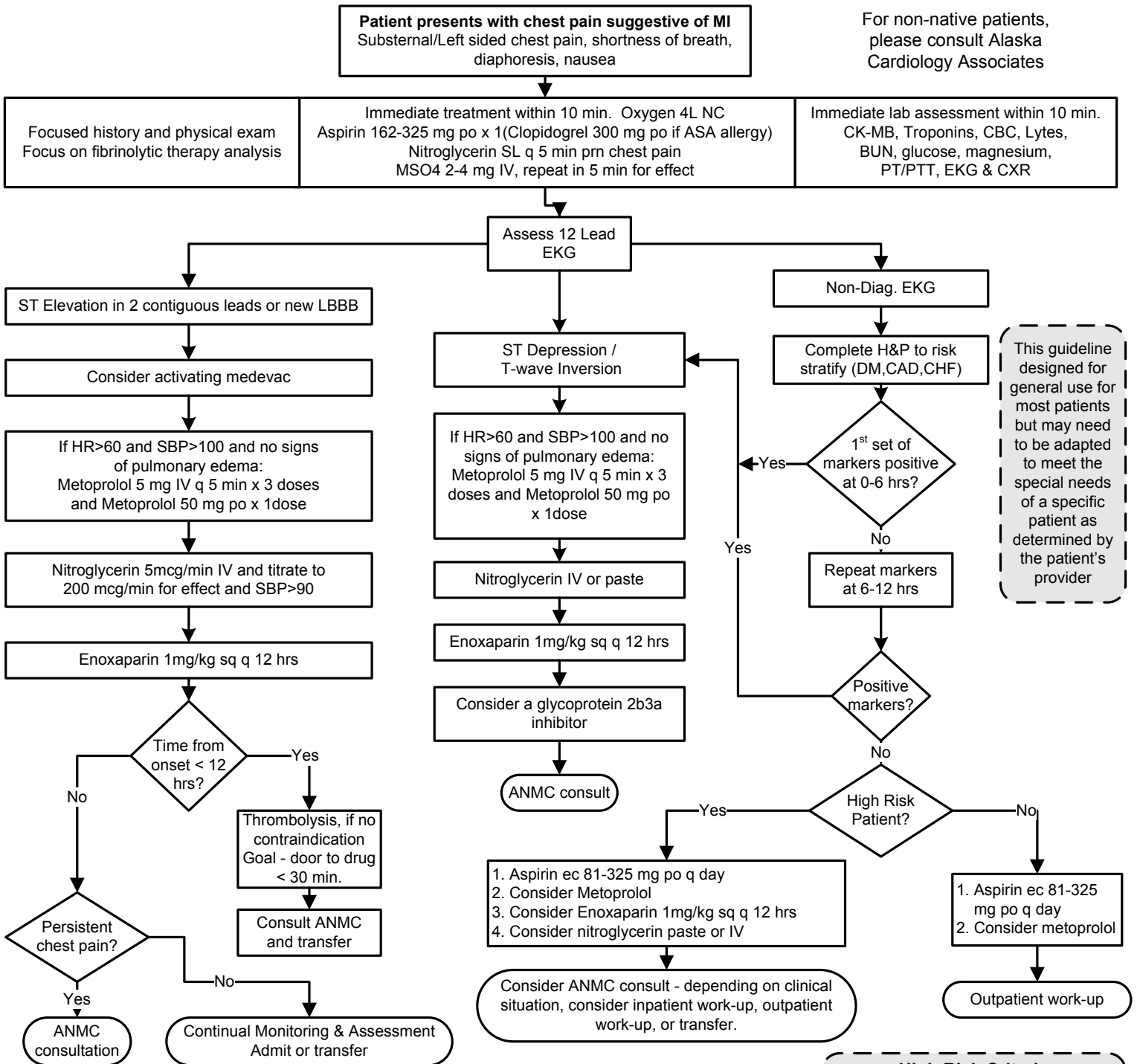

Fibrinolytic Therapy Recommendations

Indications

Chest pain suggesting MI, ST - segment elevation >0.1 mV (1mm) in 2 or more contiguous ECG leads or new LBBB, time to therapy < 12 hours, age < 75 years (age > 75 years Class Iia), evidence of ongoing ischemia

Absolute contraindications

H/O CVA; intracranial or intraspinal surgery/trauma w/in 3 wks; intracranial neoplasm, AVM, or aneurysm; active internal bleeding (menses excluded) w/in 2-4 wks; known bleeding diathesis; severe uncontrolled HTN (>180/110); terminal illness

Cautions

Recent major surgery; cerebrovascular dz; recent GI bleeding, recent trauma; high likelihood of left heart thrombus; acute pericarditis; subacute bacterial endocarditis, renal or hepatic dysfunction; pregnancy; diabetic hemorrhagic retinopathy; septic thrombophlebitis; occluded AV cannula; advanced age > 75; currently on oral anticoagulants (Coumadin); recent gp 2b/3a inhibitor; platelet <100,000, conditions where bleeding would be difficult to manage

High Risk Criteria

- Hypotension
- Persistent CP suggestive of MI
- 2 or more episodes of rest angina in previous 24 hours
- History of 3 or more cardiac risk factors
- History of Diabetes Mellitus
- Known CAD
- Age 65 years or greater
- Congestive heart failure
- New ST deviation > 0.5mm
- New pathological Q waves
- Sustained ventricular tachycardia
- Elevated cardiac makers

Title 47 Hold

MSEC approved 06/22/11

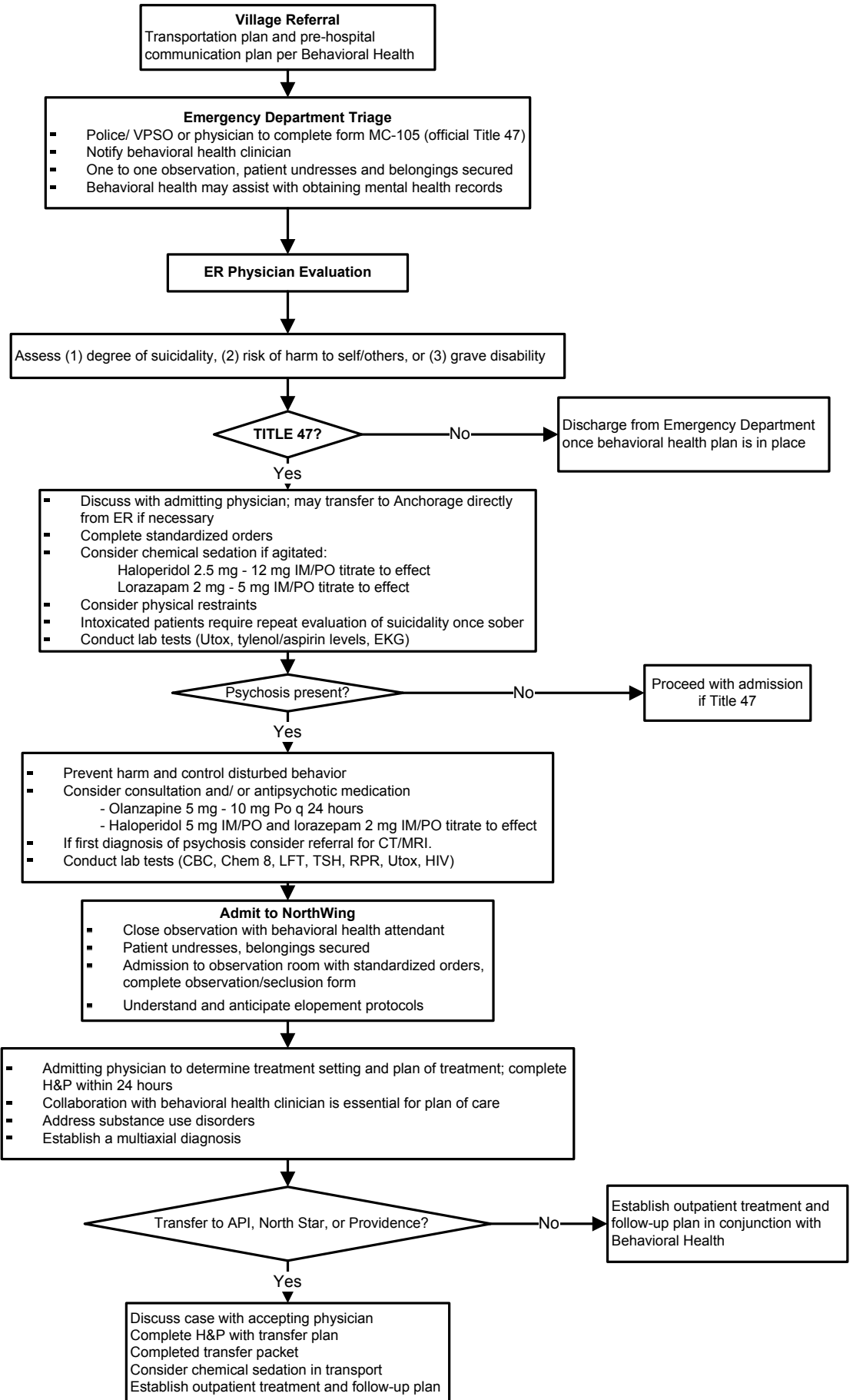

This guideline is designed for the general use of most patients, but may need to be adapted to meet the special needs of a specific patient as determined by the patient's medical practitioner.

Acetaminophen Overdose, p.1

MSEC approved 06/22/11

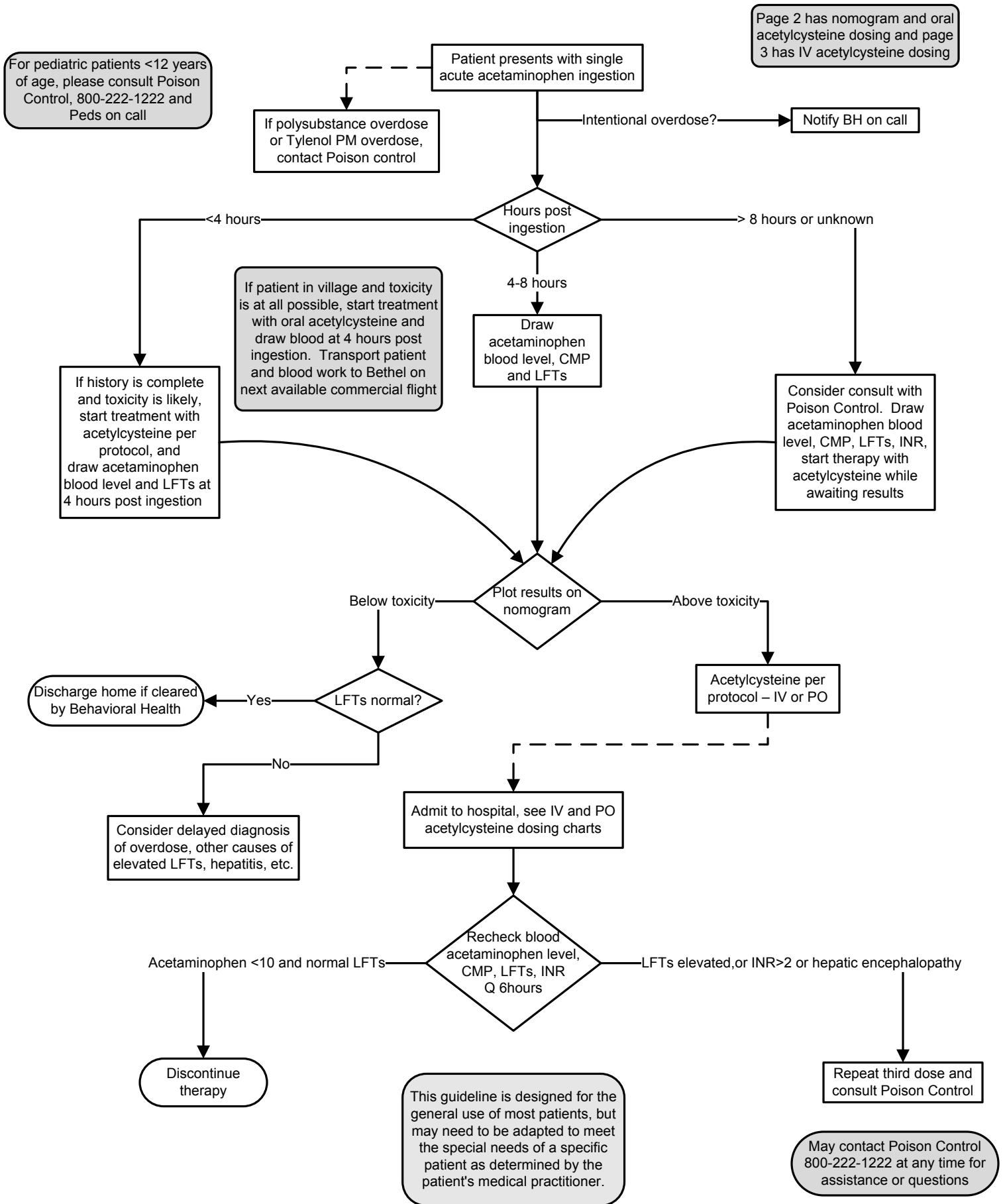

Acetaminophen Overdose p.2

MSEC approved 06/22/11

Rumack-Matthew nomogram for single acute acetaminophen poisoning

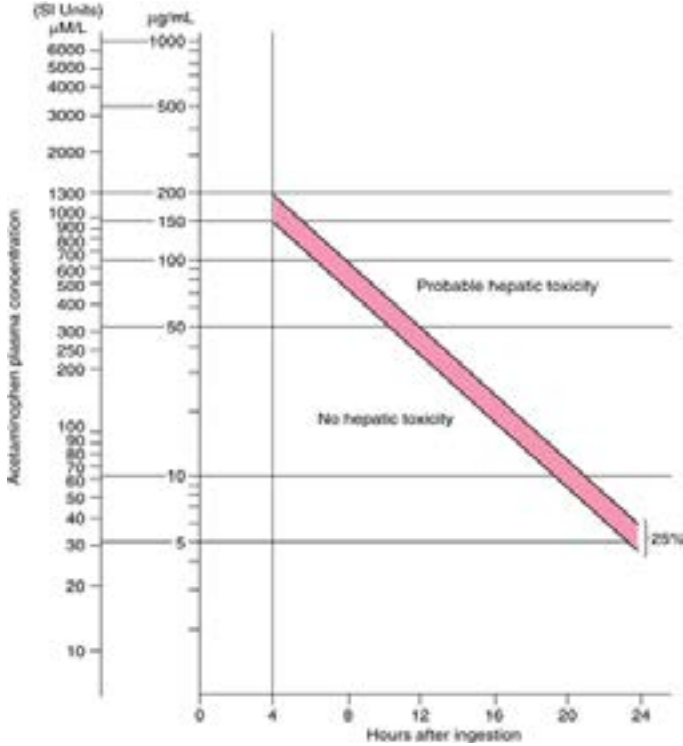

Loading dose for oral acetylcysteine

Body Weight		grams Acetylcysteine	mL of 20% Acetylcysteine Solution	mL of Diluent	Total mL of 5% Solution
(kg)	(lb)				
100-109	220-240	15	75	225	300
90- 99	198-218	14	70	210	280
80- 89	176-196	13	65	195	260
70- 79	154-174	11	55	165	220
60- 69	132-152	10	50	150	200
50- 59	110-130	8	40	120	160
40- 49	88-108	7	35	105	140
30- 39	66- 86	6	30	90	120
20- 29	44- 64	4	20	60	80

Maintenance dose for oral acetylcysteine

Maintenance Dose*					
(kg)	(lb)				
100-109	220-240	7.5	37	113	150
90- 99	198-218	7	35	105	140
80- 89	176-196	6.5	33	97	130
70- 79	154-174	5.5	28	82	110
60- 69	132-152	5	25	75	100
50- 59	110-130	4	20	60	80
40- 49	88-108	3.5	18	52	70
30- 39	66- 86	3	15	45	60
20- 29	44- 64	2	10	30	40

*If patient weighs less than 20 kg (usually patients younger than 6 years), calculate the dose of acetylcysteine. Each mL of 20% acetylcysteine solution contains 200 mg of acetylcysteine. The loading dose is 140 mg per kilogram of body weight. The maintenance dose is 70 mg/kg. Three (3) mL of diluent are added to each mL of 20% acetylcysteine solution. Do not decrease the proportion of diluent.

Acetaminophen Overdose p.3

MSEC approved 06/22/11

IV dosing of Acetadote (IV acetylcysteine)

Also go to website www.acetadote.net and there is a dosing calculator where you can enter the exact weight of the patient and get each of the 3 doses

Table 1. Three-Bag Method Dosage Guide by Weight, patients ≥ 40 kg

Body Weight		LOADING Dose 150 mg/kg in 200 mL diluent [◊] over 60 min	SECOND Dose 50 mg/kg in 500mL diluent over 4 hours	THIRD Dose 100 mg/kg in 1000mL diluent over 16 hours
(kg)	(lb)	Acetadote (mL)	Acetadote (mL)	Acetadote (mL)
100	220	75	25	50
90	198	67.5	22.5	45
80	176	60	20	40
70	154	52.5	17.5	35
60	132	45	15	30
50	110	37.5	12.5	25
40	88	30	10	20

Table 2. Three-Bag Method Dosage Guide by Weight, patients $>20 - < 40$ kg

Body Weight		LOADING Dose 150 mg/kg over 60 minutes		SECOND Dose 50 mg/kg over 4 hours		THIRD Dose 100 mg/kg over 16 hours	
(kg)	(lb)	Acetadote (mL)	Diluent [◊] (mL)	Acetadote (mL)	Diluent (mL)	Acetadote (mL)	Diluent (mL)
30	66	22.5	100	7.5	250	15	500
25	55	18.75	100	6.25	250	12.5	500

Table 3. Three-Bag Method Dosage Guide by Weight, patients ≤ 20 kg

Body Weight		LOADING Dose 150 mg/kg over 60 minutes		SECOND Dose 50 mg/kg over 4 hours		THIRD Dose 100 mg/kg over 16 hours	
(kg)	(lb)	Acetadote (mL)	Diluent [◊] (mL)	Acetadote (mL)	Diluent (mL)	Acetadote (mL)	Diluent (mL)
20	44	15	60	5	140	10	280
15	33	11.25	45	3.75	105	7.5	210
10	22	7.5	30	2.5	70	5	140

[◊]Acetadote is hyperosmolar (2600 mOsm/L) and is compatible with 5% Dextrose (D5W), ½ Normal Saline (0.45% Sodium Chloride Injection, ½ NS), and Water for Injection (WFI).

Rabies

MSEC approved 01/10/18

BOX 1
 Indications for rabies prophylaxis:
 1. The bite was from a fox, bat, coyote, skunk, woodchuck, or wolf and this animal is not available to test.
 2. The bite was from a dog who was behaving abnormally
 3. The bite was from a dog not available for quarantine.
 4. If not sure, call State section of epidemiology 907-269-8000 or 800-478-0084 after hours.

Patient reports animal bite (or exposure to brain tissue) from animal who is a possible reservoir for rabies (dog, fox, bat, wolf)

<http://dhss.alaska.gov/dph/Epi/id/Pages/rabies>
 Or open google and type in "rabies state of Alaska"

Does the patient require rabies post-exposure prophylaxis (see BOX 1)

No → Provide usual wound treatment

Yes or maybe

Patient in village?

Yes
 1. Health Aide completes visit in RAVEN
 2. Ad hoc form "Rabies Investigation Report" is started
 3. Patient is reported to RMT provider

If patient needs wound care, recommend travel to ED for treatment.

No
 1. Patient presents to ED or outpatient clinic.
 2. Ad hoc form "Rabies Investigation Report" is started

RMT provider orders the vaccine for HAND CARRY to village clinic – 3 doses

Patient is given Day 0 vaccine and the wound is infiltrated with immunoglobulin

Day 0 of series given in village clinic

Appointment is made for the outpatient clinic for Days 3, 7, 14
 -If any of these fall on a weekend, patient is seen in the ED

Day 3 vaccine and immunoglobulin given in Bethel OP clinic unless it is the weekend (then patient goes to ED)
 -Assess wound
 -Infiltrate the immunoglobulin directly into wound site

Day 7 & 14 vaccine given in village

- Animals in Alaska that have tested positive for rabies:
1. Arctic fox
 2. Caribou
 3. Cat
 4. Coyote
 5. Dog
 6. Keen's myotis bat
 7. Little brown bat
 8. Red fox
 9. Reindeer
 10. River otter
 11. Wolf
 12. Wolverine

Intoxicated ER Patient

MSEC approved 06/22/11

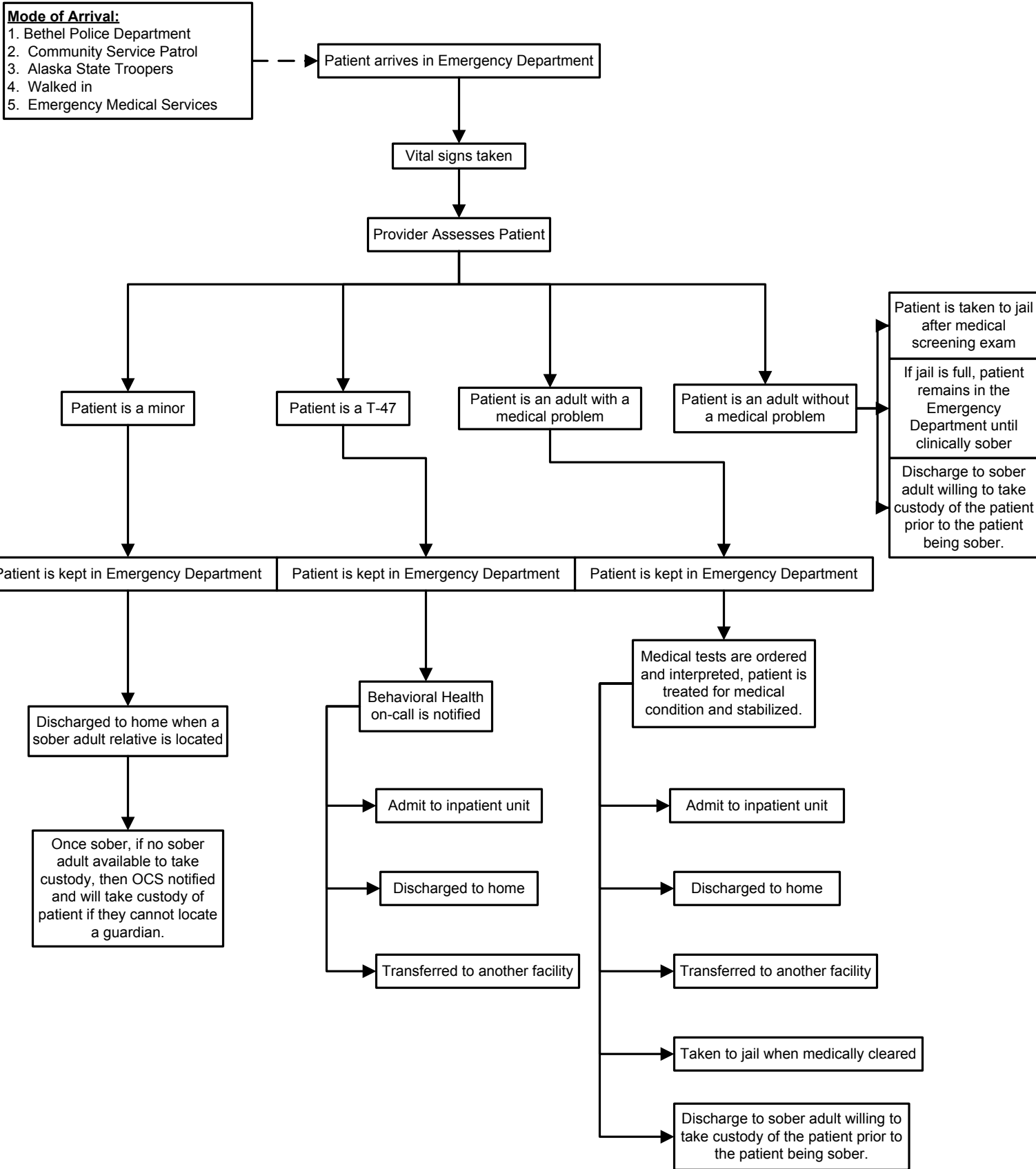

Frostbite

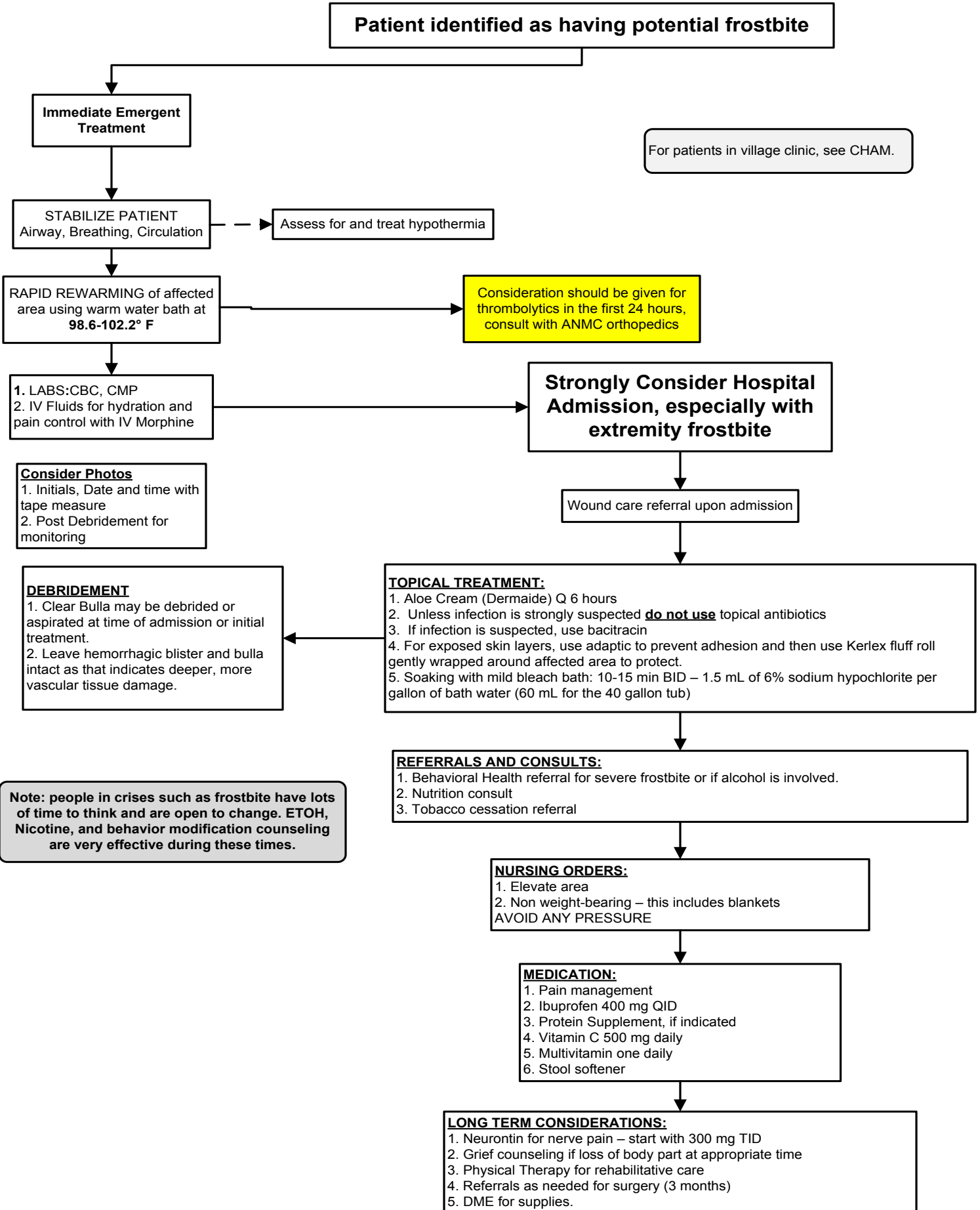

Burn Evaluation and Treatment

MSEC Approved 7/12/17

- Severe Criteria**
- Circumferential burns
 - Burns of face, neck, GU area
 - Burns across joints
 - Electrical/chemical burns
 - Inhalation injuries
 - Trauma (refer to trauma protocol)
 - Any full-thickness (3rd degree) burns

Parkland Formula
 Fluid resuscitation, used if:
 Adult TBSA > 15%
 Child TBSA > 10%

$(\text{weight in kg}) \times 4 \text{ mL} \times \% \text{TBSA} = \text{total fluid to be given over 24 hours}$

Give half in first eight hours from time of burn. Give other half over the next sixteen hours.

LR preferred.

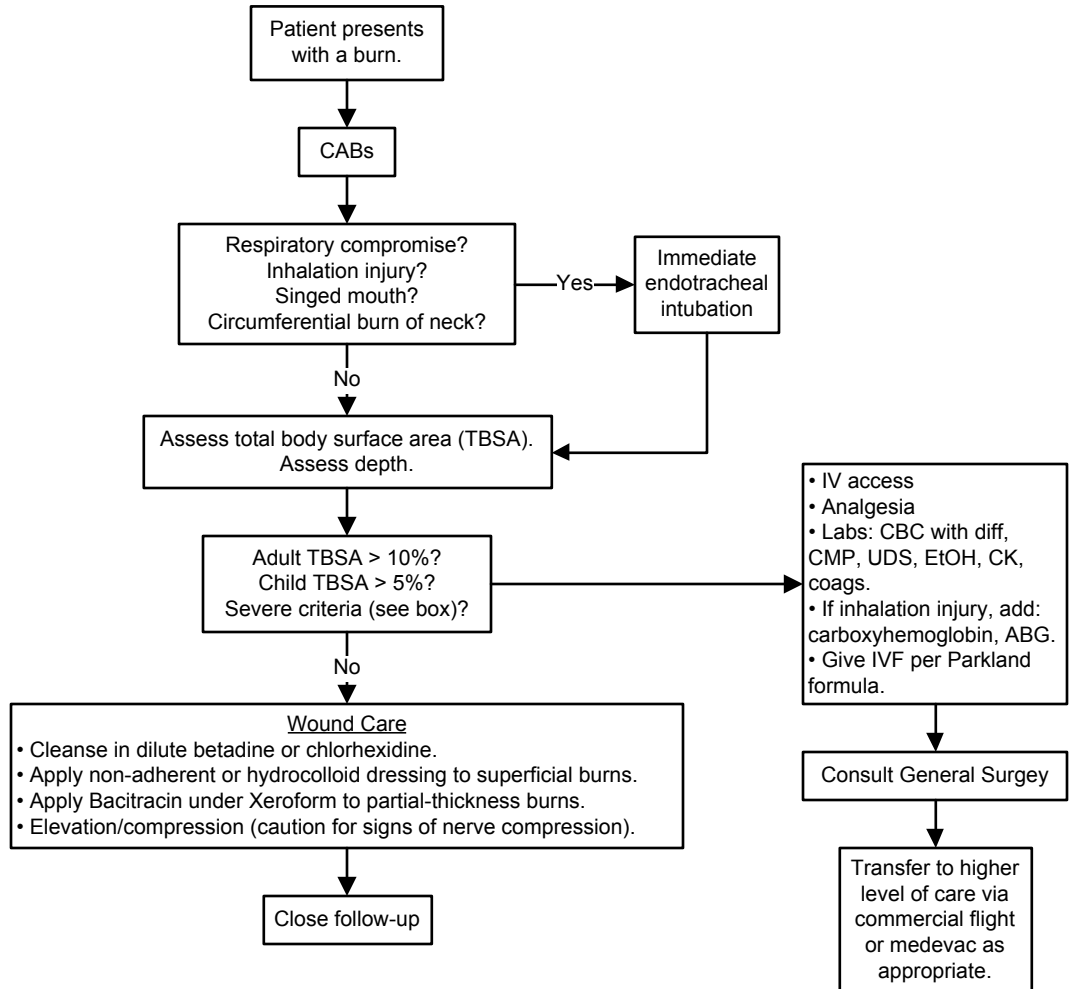

Rule of Nines to Estimate TBSA

Age	0-1	1-4	5-9	10-14	15
A - 1/2 of head	9 1/2%	8 1/2%	6 1/2%	5 1/2%	4 1/2%
B - 1/2 of one thigh	9 1/2%	8 1/2%	6 1/2%	5 1/2%	4 1/2%
C - 1/2 of one leg	9 1/2%	8 1/2%	6 1/2%	5 1/2%	4 1/2%

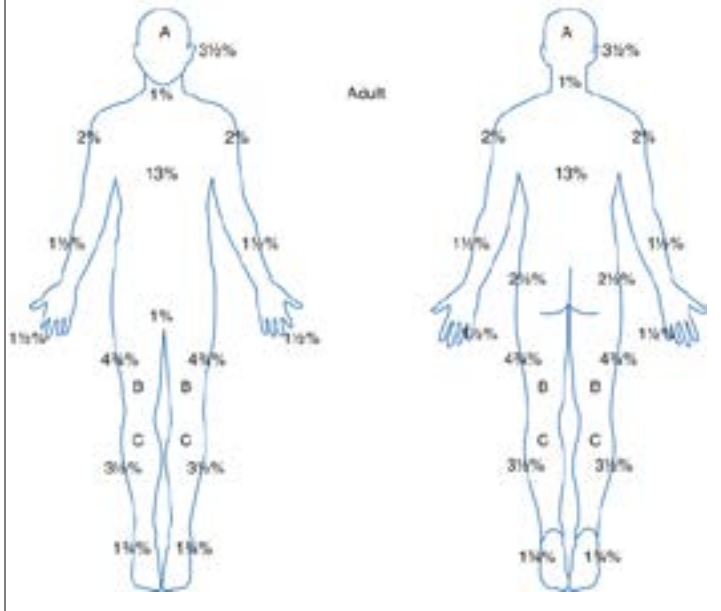

Classification of Burns by Depth

- Superficial (1st degree): epidermis only, dry, red, blanches with pressure, no blisters, painful
- Superficial partial-thickness (2nd degree): epidermis and part of dermis, blisters, moist, red, weeping, blanches with pressure, painful
- Deep partial-thickness (2nd degree): epidermis and deep dermis, blisters, wet or waxy dry, patchy white to red, does not blanch, pressure sensation only
- Full-thickness (3rd degree): epidermis and entire dermis, waxy white to leathery gray to charred/black, dry and inelastic, does not blanch, sensation to deep pressure only, may be defined as 4th degree with extension into underlying fascia, muscle, or bone

This guideline is designed for the general use of most patients but may need to be adapted to meet the special needs of a specific patient as determined by the medical practitioner.

Approved by MSEC 7/12/17.

If comments about this guideline, please contact Tara_Lathrop@ykhc.org.

First Trimester Vaginal Bleeding: Ectopic Pregnancy Diagnosis & Treatment of Non-Viable Early Pregnancy

MSEC approved 07/12/17

1
Nomenclature

- **Viable** – A pregnancy is viable if it can potentially result in a liveborn baby.
- **Nonviable** – A pregnancy is nonviable if it cannot possibly result in a liveborn baby. Ectopic pregnancies and failed intrauterine pregnancies are nonviable
- **Intrauterine pregnancy of uncertain viability** – A woman is considered to have this if a transvaginal US shows an intrauterine gestational sac with no embryonic heartbeat and no findings of definite pregnancy failure
- **Pregnancy of unknown location** – A woman is considered to have this if she has a positive urine or serum pregnancy test and no intrauterine or ectopic pregnancy on transvaginal US

2
Findings diagnostic of Pregnancy Failure

- Crown-rump length of ≥ 7 mm and no heartbeat
- Mean sac diameter of ≥ 25 mm and no embryo
- Absence of embryo with heartbeat ≥ 14 days after an US that showed a gestational sac without a yolk sac
- Absence of embryo with a heartbeat ≥ 11 days after an US that showed a gestational sac with a yolk sac

Comments

- In a woman with a positive urine or serum pregnancy test, an intrauterine fluid collection with rounded edges containing no yolk sac is most likely a gestational sac; it is certain to be a gestational sac if it contains a yolk sac or embryo.
- Transabdominal imaging without transvaginal scanning may be sufficient for diagnosing early pregnancy failure when an embryo whose crown-rump length is 15mm or more has no visible cardiac activity.

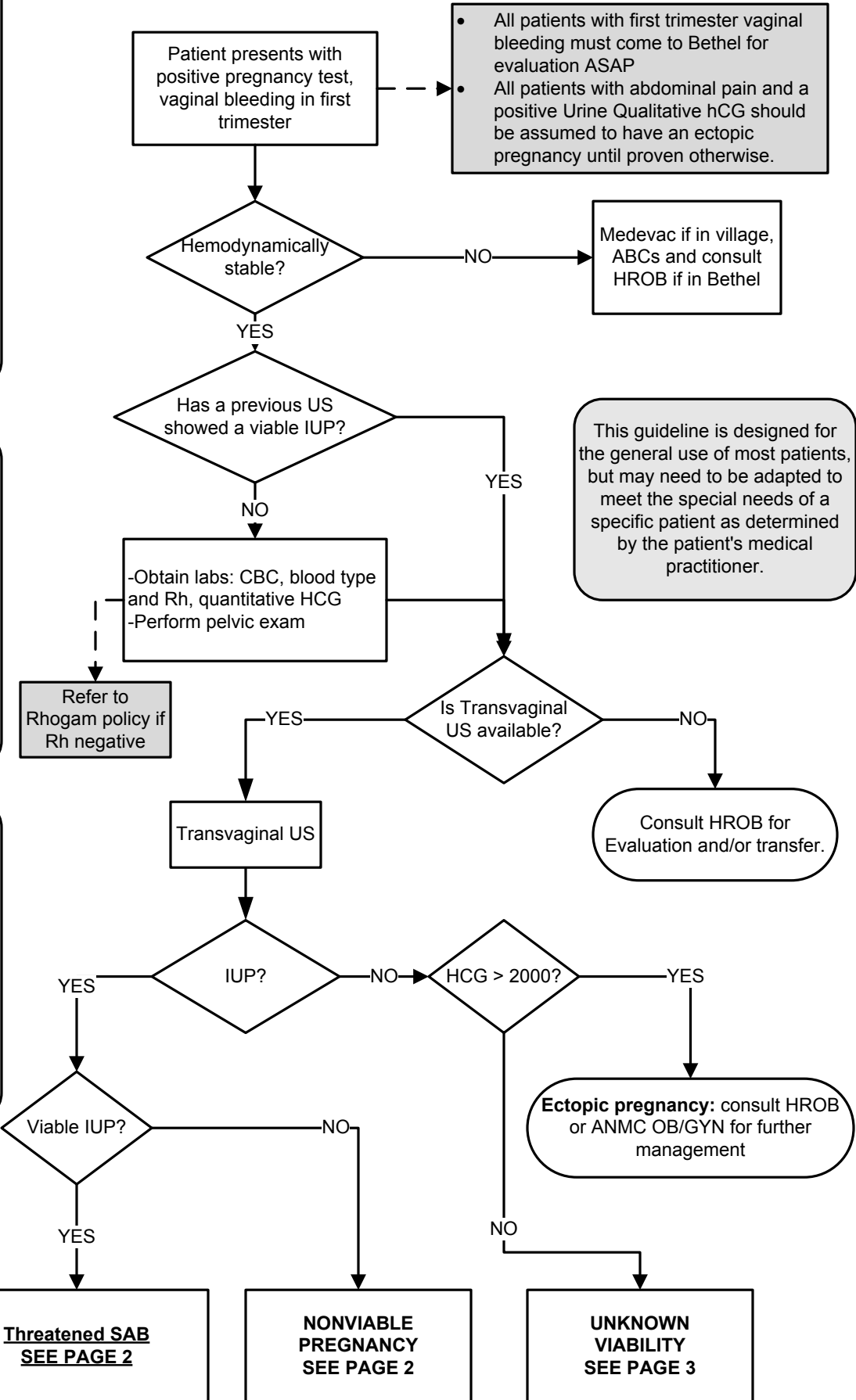

First Trimester Vaginal Bleeding: Ectopic Pregnancy Diagnosis & Treatment of Non-Viable Early Pregnancy

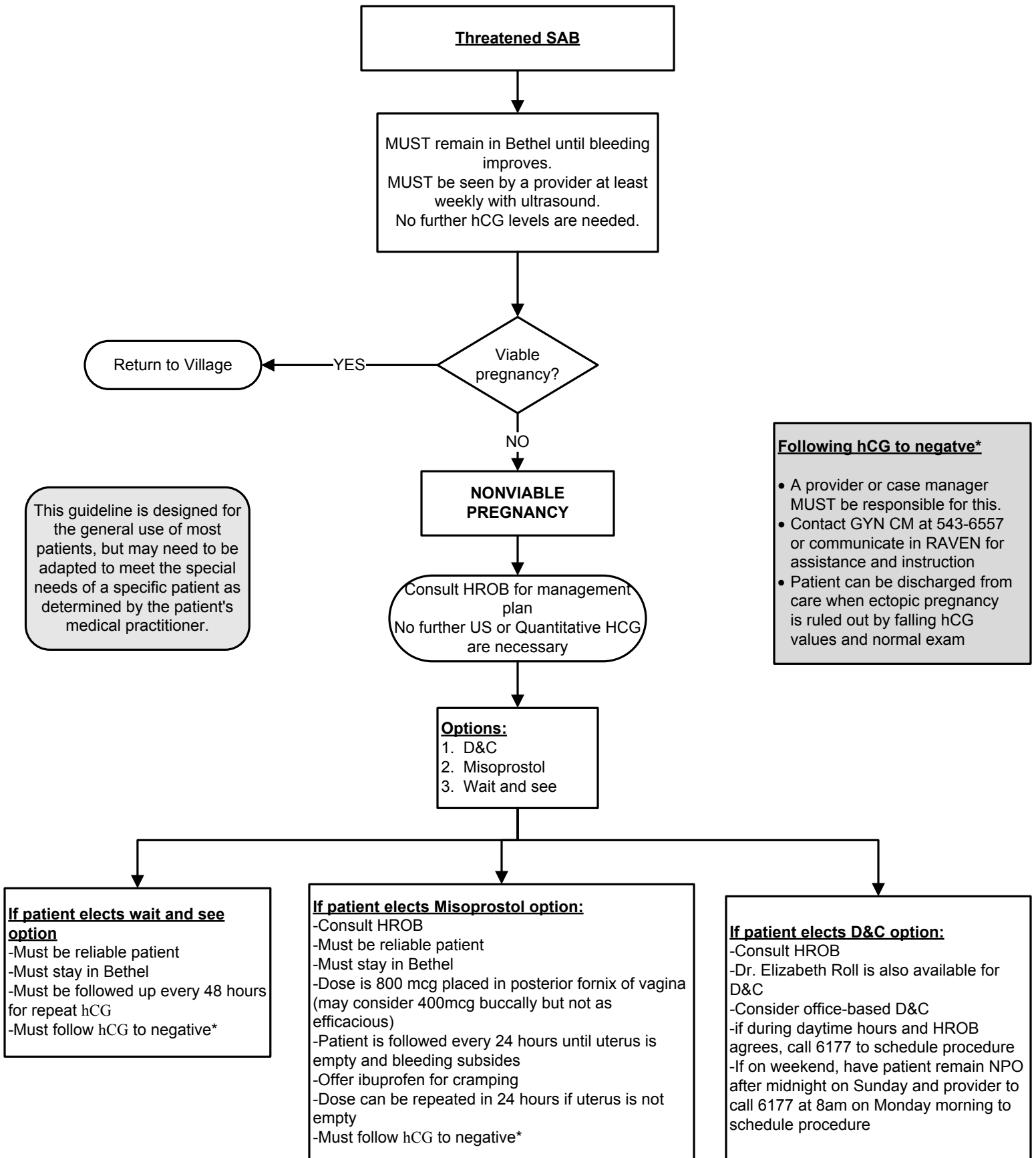

First Trimester Vaginal Bleeding: Ectopic Pregnancy Diagnosis & Treatment of Non-Viable Early Pregnancy

MSEC approved 07/12/17

PAGE 3

1 Nomenclature

- **Viable** – A pregnancy is viable if it can potentially result in a liveborn baby.
- **Nonviable** – A pregnancy is nonviable if it cannot possibly result in a liveborn baby. Ectopic pregnancies and failed intrauterine pregnancies are nonviable
- **Intrauterine pregnancy of uncertain viability** – A woman is considered to have this if a transvaginal US shows an intrauterine gestational sac with no embryonic heartbeat and no findings of definite pregnancy failure
- **Pregnancy of unknown location** – A woman is considered to have this if she has a positive urine or serum pregnancy test and no intrauterine or ectopic pregnancy on transvaginal US

2 Findings diagnostic of Pregnancy Failure

- Crown-rump length of ≥ 7 mm and no heartbeat
- Mean sac diameter of ≥ 25 mm and no embryo
- Absence of embryo with heartbeat ≥ 14 days after an US that showed a gestational sac without a yolk sac
- Absence of embryo with a heartbeat ≥ 11 days after an US that showed a gestational sac with a yolk sac

Comments

- In a woman with a positive urine or serum pregnancy test, an intrauterine fluid collection with rounded edges containing no yolk sac is most likely a gestational sac; it is certain to be a gestational sac if it contains a yolk sac or embryo.
- Transabdominal imaging without transvaginal scanning may be sufficient for diagnosing early pregnancy failure when an embryo whose crown-rump length is 15mm or more has no visible cardiac activity.

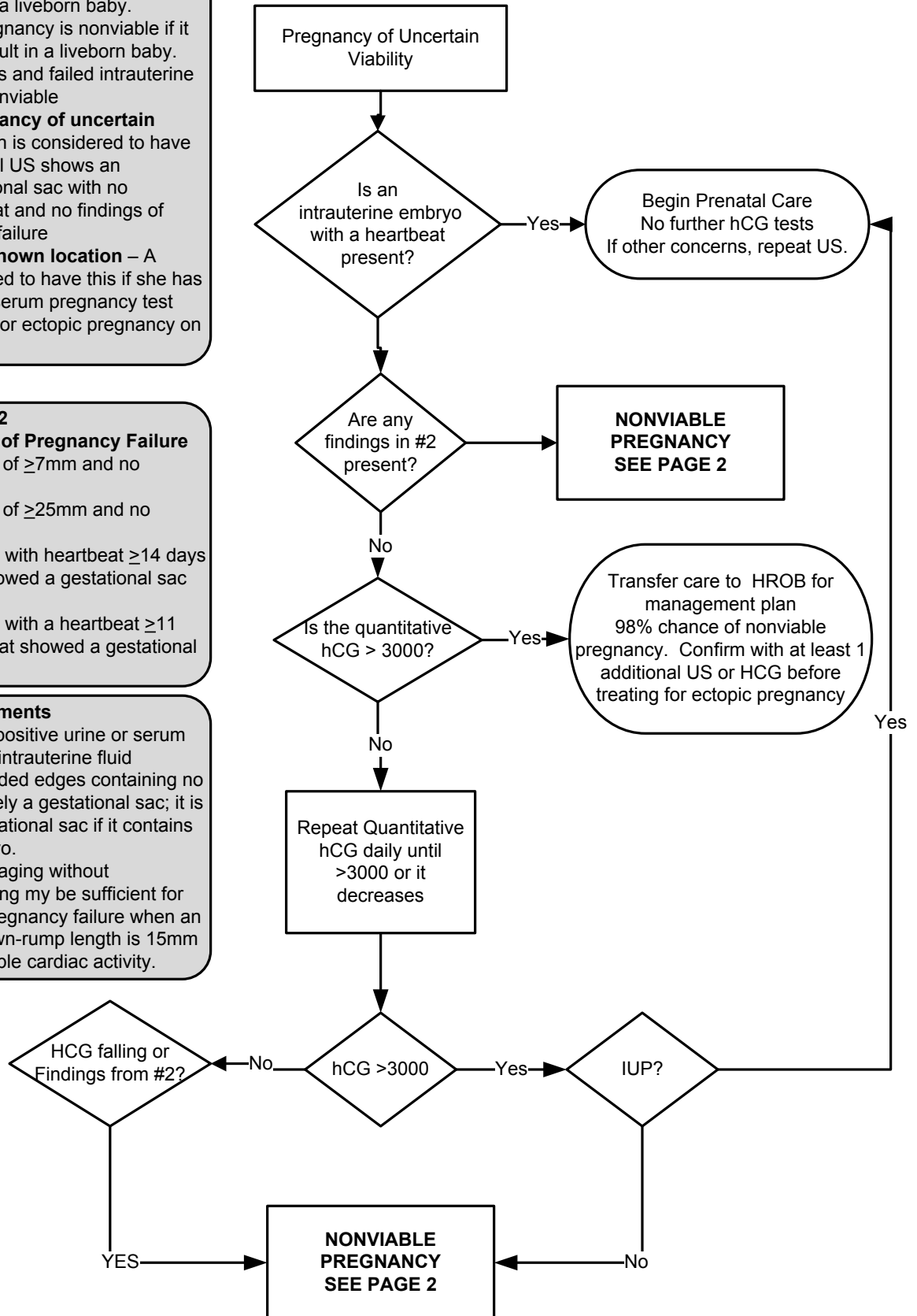

Procalcitonin (PCT) in Adult Lower Respiratory Tract Infections

Initial Values (Baseline)				
PCT Value	<0.1 ng/mL	0.1-0.24 ng/mL	0.25-0.5 ng/mL	>0.5 ng/mL
Antibiotic START Recommendation	Initiation Strongly discouraged	Initiation Discouraged	Initiation Encouraged	Initiation Strongly Encouraged
Comments	<ul style="list-style-type: none"> Hold on giving antibiotics Consider alternative diagnosis Repeat PCT in 6-12 hours if antibiotics not initiated and no clinical improvement If clinically unstable, immunosuppressed or high risk consider overruling (PSI Class IV-V, CURB-65 >3) 		<ul style="list-style-type: none"> Start antibiotics Repeat every 2-3 days to consider early antibiotic cessation. See follow-up algorithm below If initial value is >5-10 ng/mL, assess for reduction of 90% from peak values. 	
Follow-Up (Repeat PCTs q48-72 hours)				
PCT Value	<0.1 ng/mL or ↓ by >90%	0.1-0.24 ng/mL or ↓ by >80%	0.25-0.5 ng/mL	>0.5 ng/mL
Antibiotic STOP Recommendation	Cessation Strongly Encouraged	Cessation Encouraged	Cessation Discouraged	Cessation Strongly Discouraged
Comments	<ul style="list-style-type: none"> Stop antibiotics Consider continuing if clinically unstable 		<ul style="list-style-type: none"> Continue antibiotics If PCT rising or not adequately decreasing, consider possible treatment failure and evaluate for need for expanding antibiotic coverage or further diagnostic evaluation 	

PCT in Adults for Sepsis without a Source

Follow-Up (Repeat PCTs q24 hours or with AM labs daily x3 days)

PCT Value	<0.25 ng/mL	0.25-0.49 ng/mL or ↓ by >80%	≥0.5 ng/mL AND ↓ by <80%	≥0.5 ng/mL AND rising or stable
Antibiotic STOP Recommendation	Cessation Strongly Encouraged	Cessation Encouraged	Cessation Discouraged	Cessation Strongly Discouraged
Comments	<ul style="list-style-type: none"> Stop antibiotics Consider continuing if clinically unstable 		<ul style="list-style-type: none"> Continue antibiotics A PCT value which is rising or not declining at least 10% per day is a poor prognostic indicator and suggests infection is not controlled Consider expanding antibiotic coverage or further diagnostic evaluation 	

CLINICAL GUIDELINES
2019
rev. 06-27-19

Emergency Department Protocols

Use of Consultants at YKHC31

Use of Consultants at YKHC

MSEC approved 11/8/17 Updated 3/7/19

Phone Numbers
 ANMC: Consult: *97 or (907) 563-2662
 Transfer: (907) 729-2337
 PICU Cell for urgent consults: (907) 297-8809
 Providence: ED for on-call specialist: (907) 212-3111
 Trauma: (907) 212-2525
 Alaska Regional Hospital Access Center: (844) 880-5522
 VA/JBER: ED: MD consult number (907) 580-5556
 Transfer: (907) 580-6420
 Admissions 24/7 (907) 580-6423
 Operator: (907) 552-1110
 Harborview Seattle (burns): (888) 731-4791

Page the appropriate provider in Anchorage
 1. ANMC for beneficiaries
 2. Providence Hospital or Alaska Regional Hospital for non-beneficiaries
 3. Alaska Regional for prison inmate
 4. VA or JBER (Joint Base Elmendorf/ Richardson) for veterans

Once speaking with the appropriate provider be able to:
 1. State your name, title and department (i.e. ER physician, outpatient NP, second year resident, etc)
 2. State purpose of call (i.e. quick question, possible admission, management advice.)
 3. Provide name, MRN, age, DOB. If the patient is pregnant, give gravity and parity and gestational age in initial sentence, if the patient is a child, give the age in the initial sentence.
 4. Be able to use the SBAR method to communicate patient details (see box below)
 5. Ask a **specific question** about management.
 6. Let accepting physicians know whether you think that the patient can travel by commercial flight or will require air medevac
 7. If there is a problem getting an accepting physician for a medevac/transfer or with patient management decisions, see NOTE below

Document consultant advice in the medical record, include date, time, first and last name of consultant and a summary of the advice given

Provider needs consultation about patient at YKHC

Consult provider is located in Bethel?

No

Yes

Patient is critically ill and the consultant is required at bedside?

No

Yes

Page provider STAT to come to bedside and assist in management.

If on-going management is required, a decision must be made **immediately** and **communicated** about who will be the primary managing provider giving orders and documenting in the medical record.

Once patient is stabilized, discussion will occur between the primary provider and the consultant regarding documentation of the patient's medical care in the record and ongoing management.

If you're an SRC provider, you do not have the luxury of paging the provider STAT to bedside, for the purposes of this protocol, the SBAR case presentation and the documentation requirements apply.

Remember: Unless you transfer care of the patient, YOU are responsible for orders, documentation and notifying the patient and family of the plan of care.

Page the appropriate provider. Have ready the following information:
 1. State your name, title and department (i.e. ER physician, outpatient NP, second year resident, etc)
 2. State purpose of call (i.e. quick question, possible admission, management advice.)
 3. Name, MRN, age, DOB. If the patient is pregnant, give gravity and parity and gestational age in initial sentence, if the patient is a child, give the age in the initial sentence.
 4. Be able to use the SBAR method to communicate patient details (see box below)
 5. Ask a **specific question** about management.

Provider requesting consult must document consultant's advice in the medical record. Include date, time, first and last name of consultant and a summary of the advice given

At any time in the process, if the primary provider wants support at the bedside, page the consultant and ask them to come to bedside and provide support

Clear role delineation must occur establishing who is the primary managing provider.

SBAR:
Situation: a concise statement of the problem, a "one-liner"
 "This is a 3 year old otherwise healthy girl with a fever..."
 "My patient is a 20 year old G3P2 at 26 weeks with vaginal bleeding..."
 "I'm taking care of a 21 year old male with fever and abdominal pain..."
Background: pertinent and brief information related to the situation
 "The labs are normal and CXR shows no infiltrate but her pulse is elevated..."
 "I have performed a sterile speculum exam and there is frank blood in the vault..."
 "The patient's CT show appendicitis and the patient is vomiting all intake..."
Assessment: analysis and consideration of options, what you found/think
 "I think she needs a fluid bolus but I am wondering if she also needs a UA..."
 "I think this patient might have an active abruption..."
 "I think this patient has appendicitis and needs to be transferred to ANMC..."
Recommendation: action requested, what you want
 "I want your opinion on how much fluid and the need for a UA..."
 "I want you to come in and asses this patient in person..."
 "I would like to transfer this patient via medevac to ANMC..."

NOTE:
 If there is a disagreement regarding the management of a patient between the consultant and the primary provider, the primary provider will advise the consultant as to the reason for the disagreement. If a consensus cannot be reached, a third opinion shall be obtained. This can either be from a YK based provider or from a provider from another facility. At any time the Clinical Director on call can also be notified.

CLINICAL GUIDELINES

2019

rev. 06-27-19

Pediatric Emergency Guidelines

(For Pediatric Critical Care Weight-Based Guide, see https://yk-health.org/wiki/File:Pediatric_critical_care_guide.pdf)

Critical Care and Medevac Guide – Pediatric.....	33
Intubation – Pediatric.....	34
High-Flow Nasal Cannula (HFNC) — Pediatric.....	35
Sepsis – Pediatric.....	36
Seizure Evaluation – Pediatric.....	37
Seizure Treatment – Pediatric.....	38
Fever – Infants 0-90 days.....	39
Croup/Stridor: Evaluation & Treatment.....	40
Bronchiolitis / Wheezing – 3-24 Months.....	41
Pneumonia – Pediatric > 3 Months.....	42
Suspected Child Sexual Abuse Procedure.....	43
Head Injury/Concussion <18 Years.....	44
Amoxicillin Allergy Trials.....	45

Critical Care and Medevac Guide – Pediatric

MSEC Approved 9/13/17

Call pediatric hospitalist for all potentially critical pediatric patients.

Remember: non-beneficiary patients are transferred to Providence Alaska Medical Center. Call their PICU at (907) 212-3133 to obtain accepting physician (PICU or hospitalist). Inquire about medevac insurance coverage.

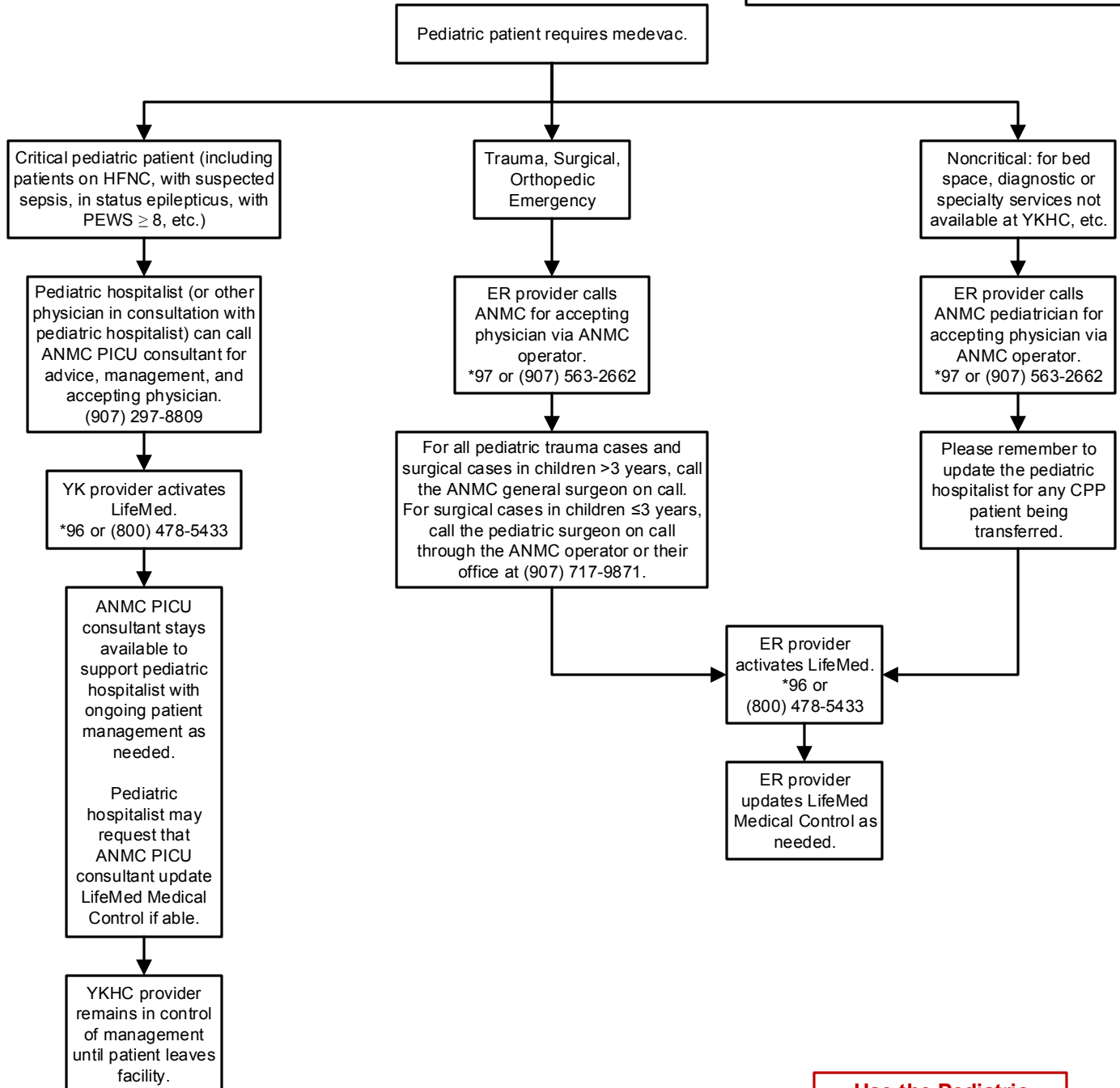

Use the Pediatric Critical Care Guide and ED Peds Critical Care PowerPlan.

This guideline is designed for the general use of most patients but may need to be adapted to meet the special needs of a specific patient as determined by the medical practitioner.

Intubation – Pediatric

MSEC approved 07/12/17

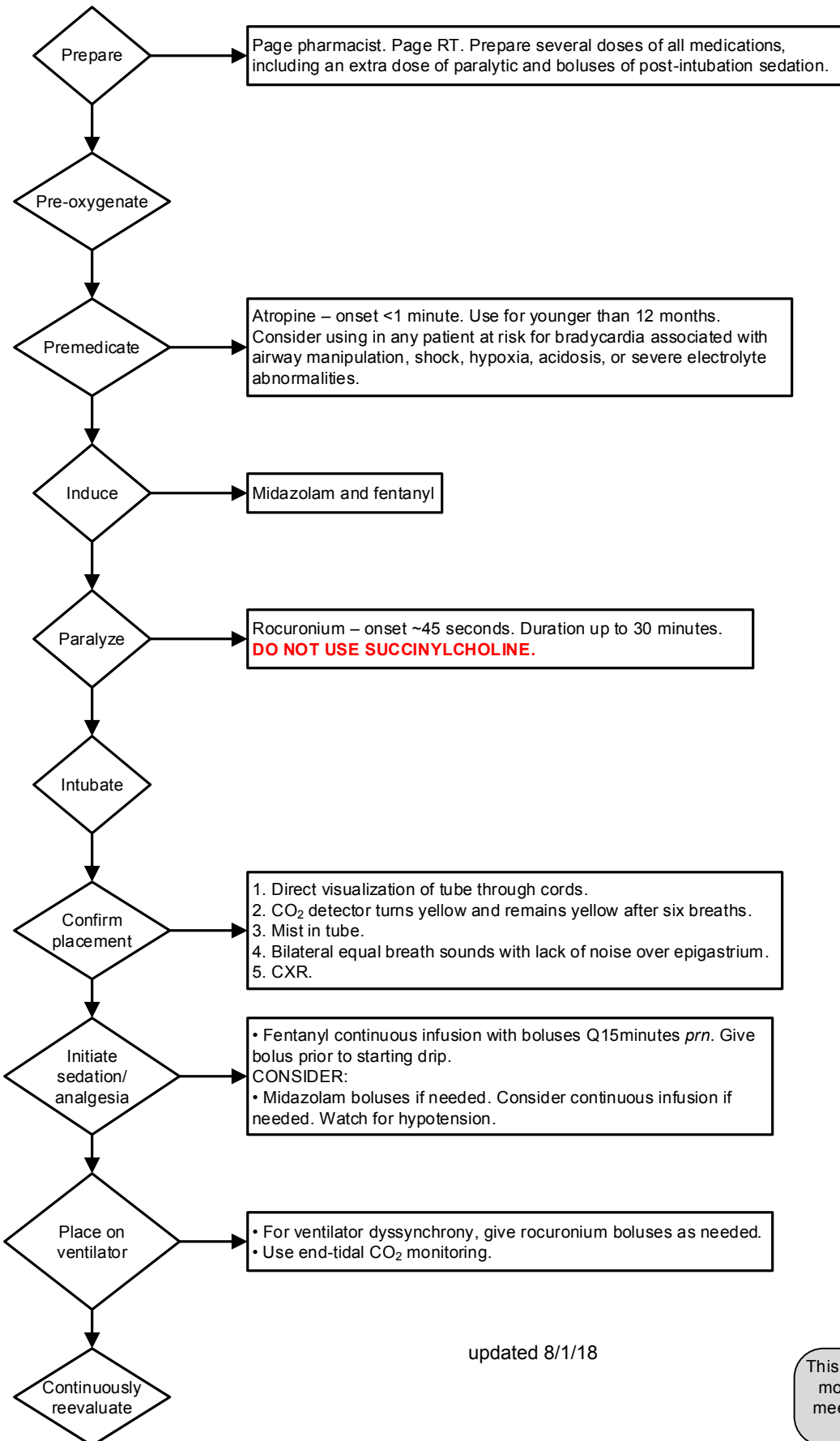

REMEMBER:
Helpful resources include:

- Pharmacist on-call
- Respiratory therapist
- CRNA on-call
- Difficult Airway Drawer with laryngeal mask airway (LMA)
- GlideScope®

Always place NG/OG tube for decompression.

Use the Pediatric Critical Care Guide and ED Peds Critical Care PowerPlan for all medication dosing.

Note: Secure tube with cloth tape. Do not use a commercial tube holder device for tubes 5.0 and smaller.

updated 8/1/18

This guideline is designed for the general use of most patients but may need to be adapted to meet the special needs of a specific patient as determined by the medical practitioner.

High-Flow Nasal Cannula (HFNC) — Pediatric

MSEC Approved 7/12/17 • Minor revisions 07-26-18

REMEMBER:

- Any pediatric patient on HFNC must be transferred to the ER except for newborns, who may stay in the nursery.
- Maintain patient on HFNC until medevac crew arrives.
- No pediatric patient may be kept at YKDRH on HFNC unless medevac is on weather-hold.

Patient with moderate to severe sustained retractions or sustained hypoxia <88% not improved with **SUPPORTIVE MEASURES** (see box) and 2 LPM conventional nasal cannula or infant with apnea responsive to stimulation

SUPPORTIVE MEASURES

- Control fever, as it can be an independent cause of respiratory distress.
- Nasal suction.
- IV hydration.
- Back-to-back nebs with albuterol or normal saline.
- Consider phenylephrine ophthalmic form 1-2 drops to each nostril once.
- Consider hypertonic saline nebs q6h.

Page respiratory therapist.

Page pediatrician on-call.

- Transfer to ER.
- Activate medevac.
- **PREPARE PATIENT** (see box).

PREPARE PATIENT

- Make patient NPO.
- Ensure reliable IV access.
- Suction nares well.
- Choose a nasal cannula with prongs that do not occlude more than 50% of the nares.
- Optimal patient position is semi-recumbent, not supine or upright. Consider using special blue seat (found in ER storage between trauma and ambulance bays) with adjustable angle. Use blanket rolls to support position and ensure patient is not slumping over.
- To prevent condensation causing problems, place patient at a higher level than unit and clip tubing to patient's clothing.

NOTE:

- Low-flow cartridge to be used with neonatal/ infant cannula and produces flow rates of 1-8 LPM. This should only be used in the nursery.
- High-flow cartridge to be used with larger cannula and produces flow rates of 5-40 LPM. In the ER, always start with the high-flow cartridge.

RT to start high-flow nasal cannula with pediatrician consultation.

Initial Settings
See Flow Rates box to left.
FiO2 50%, 37°C.
For newborns, consult neonatologist.

Flow Rates

Titrate flow to 0.5-2 LPM/kg.

- Children <5 kg often require 1-2 LPM/kg.
- Children 5-10 kg often require 1-1.5 LPM/kg.
- Children >10 kg often require 0.5-1 LPM/kg.

Listen to lungs with each adjustment. If child is unable to easily exhale or complete an expiration, decrease flow rate until expiration is adequate.

Titrate flow by 1 LPM increments over first 3 minutes until improvement in WOB. If patient is worsening on high flow rates, consider a lower flow rate.

Troubleshooting

- Consider NG/OG-tube for decompression.
- Use a pacifier to keep the patient's mouth closed and prevent loss of pressure.
- Consider mild sedation in consultation with medical control.
- Consider higher levels of flow to improve washout.

Titrate FiO2 to maintain sats >92%.

Frequent gentle nasal suction as needed.

Reassess at least Q20-30 minutes.

Signs of Clinical Improvement

- ↓RR
- ↓retractions
- ↓irritability
- improved air movement

If no improvement, consider obtaining ANMC PICU consult, checking blood gas, increasing supportive measures, intubation, etc.

Maintain current settings until medevac arrives.

This guideline is designed for the general use of most patients but may need to be adapted to meet the special needs of a specific patient as determined by the medical practitioner.

Sepsis – Pediatric

MSEC approved 07/12/17

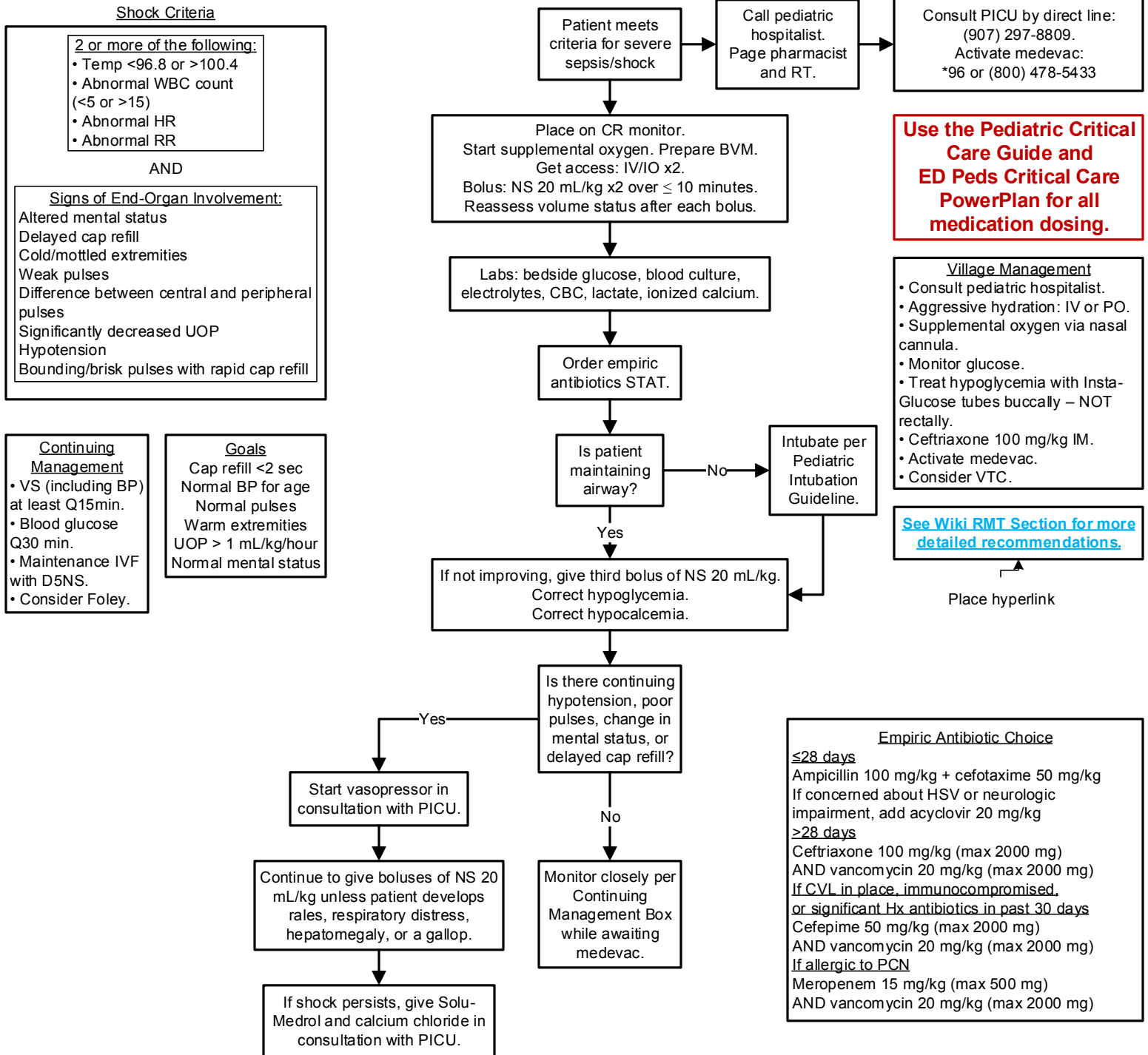

Age	HR (beats/minute)		RR (breaths/minute)		Hypotension (sBP in mmHg)
	Bradycardia	Tachycardia	Low	High	
0 days – 1 week	<100	>200	<30	>70	<80
1 week – 1 month	<100	>200	<30	>70	<80
1 – 3 months	<100	>180	<20	>60	<70
3 – 12 months	<100	>180	<20	>60	<70
1 – 2 years	<90	>160	<20	>40	<70
2 – 6 years	<60	>160	>40	>40	<80
6 – 13 years	<60	>120	>23	>23	<90
13 – 18 years	<60	>110	>23	>23	<90

This guideline is designed for the general use of most patients but may need to be adapted to meet the special needs of a specific patient as determined by the medical practitioner.

Seizure Evaluation – Pediatric

MSEC approved 5/8/19

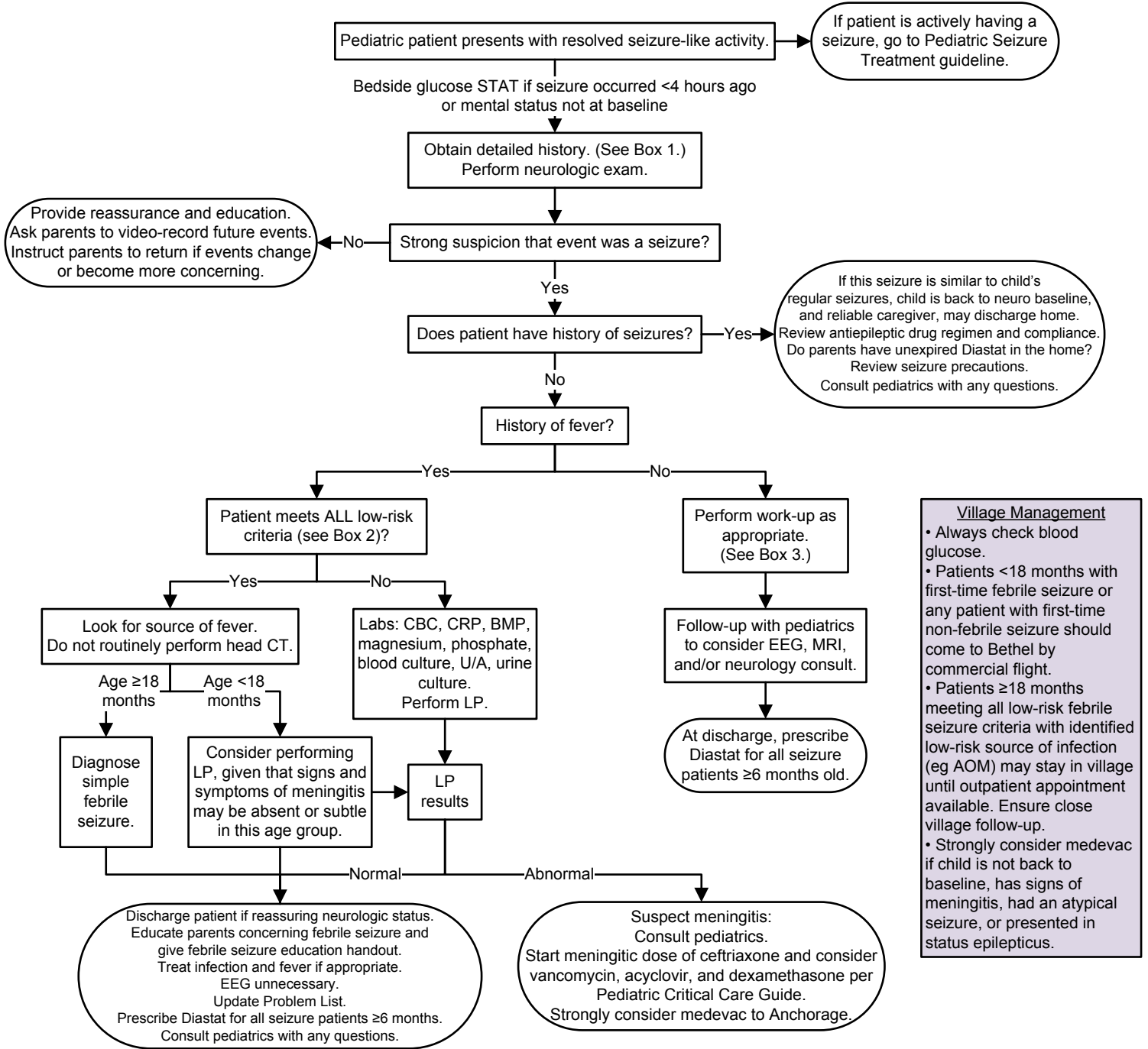

Village Management

- Always check blood glucose.
- Patients <18 months with first-time febrile seizure or any patient with first-time non-febrile seizure should come to Bethel by commercial flight.
- Patients ≥18 months meeting all low-risk febrile seizure criteria with identified low-risk source of infection (eg AOM) may stay in village until outpatient appointment available. Ensure close village follow-up.
- Strongly consider medevac if child is not back to baseline, has signs of meningitis, had an atypical seizure, or presented in status epilepticus.

Box 1: Detailed History

- When/where did it occur? Awake or asleep?
- What preceded the event (eg head trauma, crying, etc.)?
- How long did it last?
- Ask caregiver to recount, step-by-step, what happened.
- Type of movement and what part of body? Symmetric?
- Interventions?
- Incontinence?
- Behavior after event? How long till back to baseline?

HPI

- Intercurrent illness/fevers
- Medications
- Recent intake, including free water and diluted formula
- Ingestions
- Trauma

PMH

- Prior history of seizures
- History of breathholding

Family Hx: Seizures, febrile seizures, breathholding, etc.

Box 2: Low risk febrile seizure criteria

1. 6 months to 4 years of age.
2. Fever present.
3. Seizure generalized (nonfocal).
4. Seizure duration <5 minutes.
5. Child has normal neurologic examination.
6. Child has no history of previous neurologic or CNS abnormality.
7. Only one seizure in a 24 hour period.
8. Child has returned to baseline.
9. No meningeal signs:
 - Irritability or inconsolability
 - Nuchal rigidity
 - Bulging fontanelle
 - Lethargy or somnolence
 - Focal neurologic findings
10. Child has NOT received antibiotics in the past 72 hours.

Box 3: Work-up

- Bedside glucose
- EKG for first event
- BMP, magnesium, phosphate
- Urine drug screen
- Perform LP if persistent altered mental status, meningitis suspected, or <18 months of age and delayed return to baseline.

Radiological studies:

- Obtain head CT prior to LP if concerning neurologic status, persistently altered mental status, history of trauma, or focal neurological findings.

This guideline is designed for the general use of most patients but may need to be adapted to meet the special needs of a specific patient as determined by the medical practitioner.
 Approved by MSEC 5/8/19.
If comments about this guideline, please contact Leslie_Herrmann@ykhc.org.

Seizure Treatment – Pediatric

MSEC approved 5/8/19

If in the ER or NW, ask a nurse to get the Peds Seizure Kit. Tell him/her to type "seizure" in the Pyxis.

Use the Pediatric Critical Care Guide and ED Peds Critical Care PowerPlan to check all medication dosing.

ER Management Note: Peds Seizure Kit includes dosing.
Lorazepam 0.1 mg/kg IV/IO (max dose 4 mg) or midazolam 0.2 mg/kg intranasal (max dose 10 mg) if no IV access.

Village Management See Emergency RMT Seizure Scenario on the wiki.

- ABCs.
- **Bedside glucose STAT.**
- If unable to get a glucose measurement, give glucose buccally.
- Get BVM with appropriate sized mask to bedside.
- Follow flow to the left, using these drugs with dosing found on Pediatric Critical Care Guide:
 - Diastat home dose PR if available or midazolam 0.2 mg/kg intranasal (max dose 10 mg) or diazepam 0.5 mg/kg (max 10 mg) IV solution given RECTALLY.
 - Phenobarbital 20 mg/kg IM (max dose 1000 mg). If giving phenobarbital, consult pediatrics, notify ER, and strongly consider activating a medevac.
- Low threshold to activate medevac for atypical or prolonged seizure.

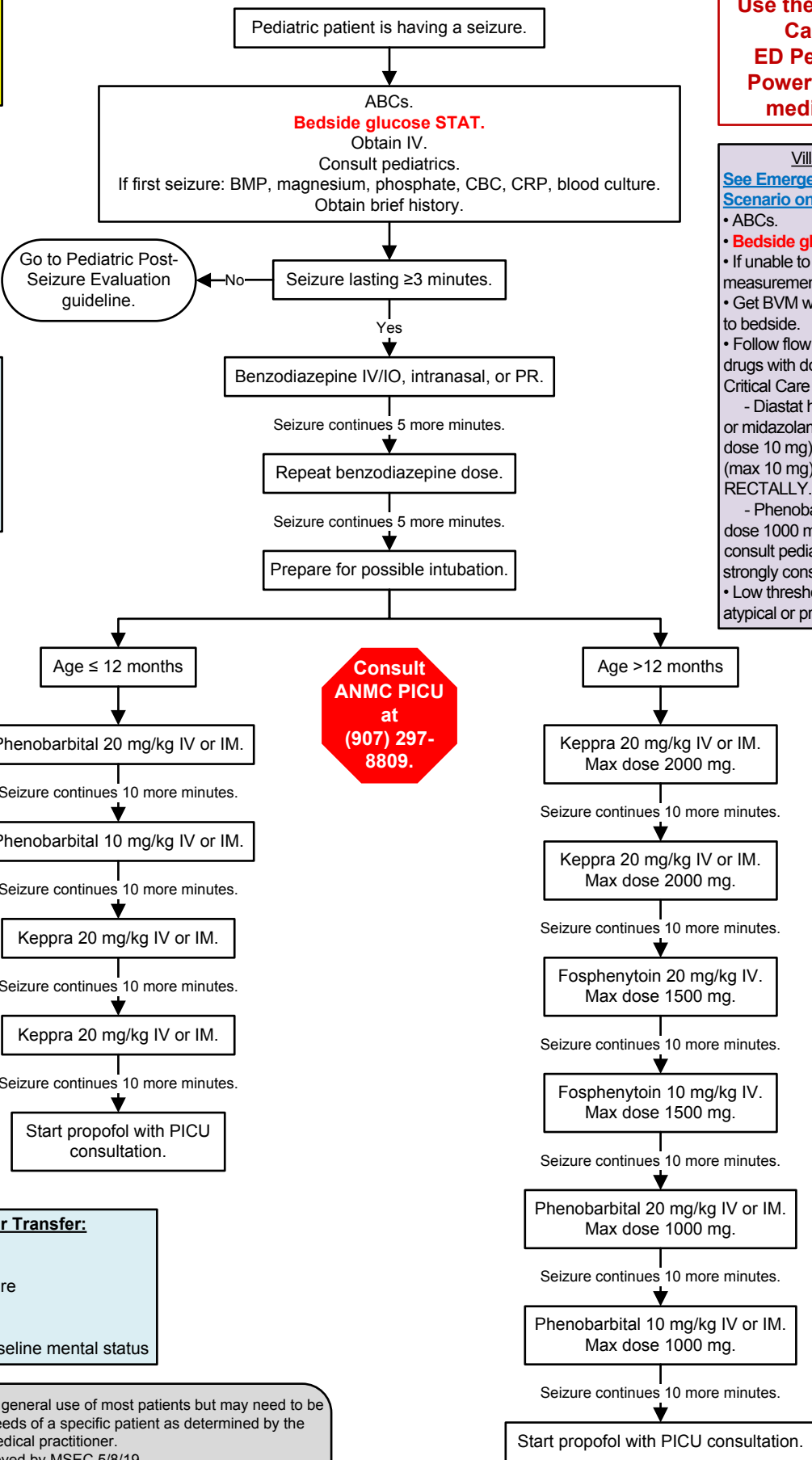

Note: If febrile seizure with status epilepticus, consider giving phenobarbital after benzodiazepines prior to Keppra in any age group.

Indications for Admission or Transfer:

- Status epilepticus
- Cluster of seizures
- Increased intracranial pressure
- CNS infection
- Structural lesion
- Patient does not return to baseline mental status

This guideline is designed for the general use of most patients but may need to be adapted to meet the special needs of a specific patient as determined by the medical practitioner.
Approved by MSEC 5/8/19.
If comments about this guideline, please contact Leslie_Herrmann@ykhc.org.

Fever – Infants 0-90 days

MSEC Approved 5/8/19

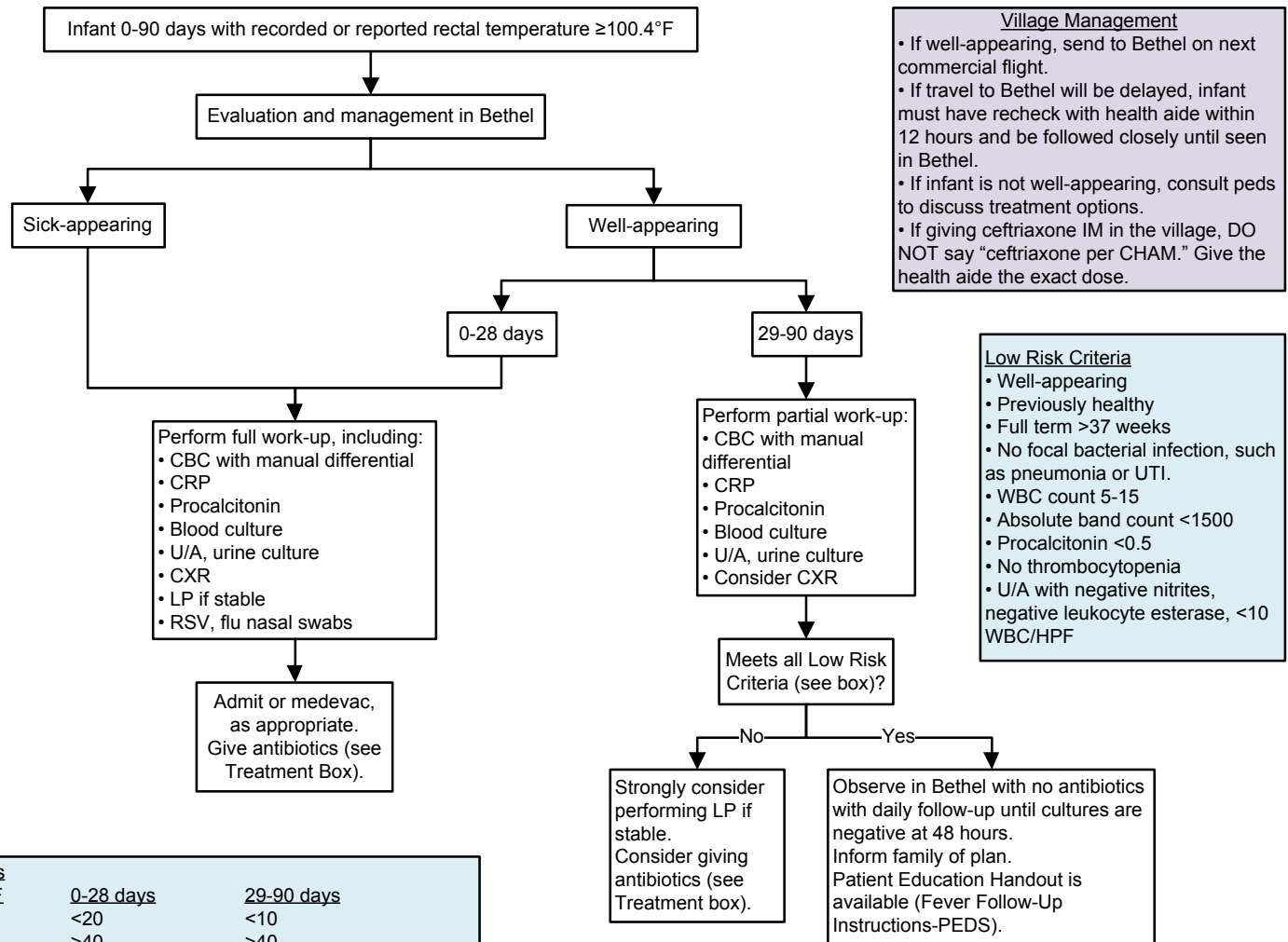

Village Management

- If well-appearing, send to Bethel on next commercial flight.
- If travel to Bethel will be delayed, infant must have recheck with health aide within 12 hours and be followed closely until seen in Bethel.
- If infant is not well-appearing, consult peds to discuss treatment options.
- If giving ceftriaxone IM in the village, DO NOT say “ceftriaxone per CHAM.” Give the health aide the exact dose.

Low Risk Criteria

- Well-appearing
- Previously healthy
- Full term >37 weeks
- No focal bacterial infection, such as pneumonia or UTI.
- WBC count 5-15
- Absolute band count <1500
- Procalcitonin <0.5
- No thrombocytopenia
- U/A with negative nitrites, negative leukocyte esterase, <10 WBC/HPF

CSF Results

Normal CSF	0-28 days	29-90 days
WBC	<20	<10
Glucose	>40	>40
Protein	<100	<75

Absence of neutrophils (polys) makes bacterial meningitis unlikely. CSF neutrophils (polys) >75% increases likelihood of bacterial meningitis.
Do not use correction formulas for traumatic LPs.

Special Circumstances

1. Immunizations within 24 hours of fever <101 and well-appearing: no work-up necessary but must follow-up in village or Bethel within 12-24 hours. If fevers persist or infant is not well-appearing, perform work-up as above.
2. Pre-treatment with antibiotics with no focal bacterial infection: infant must be observed a full 48 hours off antibiotics. This may require staying in Bethel for 48 hours of antibiotics followed by another 48 hours of observation off antibiotics with daily follow-up. Consider ordering CSF Multiplex PCR, a send-out test.
3. Unsuccessful LP: treat if appropriate and consider a repeat LP in 12-24 hours and determine treatment course based on cell counts. If repeat LP not performed or unsuccessful, either treat for 10-14 days with meningitic dosing of IV antibiotics or stop antibiotics at 48 hours and observe infant for an additional 48 hours off antibiotics. Consider admission.

HSV Work-up

- CSF HSV PCR
- Blood HSV PCR
- CMP
- Nasopharyngeal, conjunctival, and anal swabs and vesicle fluid for HSV PCR.

Risk-Stratification Resource:
[Kaiser Neonatal Sepsis Calculator](#)

Treatment

No febrile infant <90 days should receive antibiotics without an LP.

- 0-7 days: please consult a pediatrician, pharmacist, or Neofax.
- 8-28 days:
 - If well-appearing and low suspicion for meningitis: ampicillin 50 mg/kg IV Q8h AND gentamicin 4 mg/kg IV Q24h
 - If well-appearing and any suspicion for meningitis: ampicillin 75 mg/kg IV Q6h AND cefepime 50 mg/kg IV Q12h
 - If ill-appearing and/or positive CSF Gram stain: please consult a pediatrician and/or a pharmacist.
- 29-90 days: ceftriaxone 75 mg/kg IV/IM Q24h OR if worried about meningitis 100 mg/kg IV once then 50 mg/kg IV Q12h
- Continue IV/IM antibiotics until cultures are negative and patient is clinically stable x48-72 hours or until specific organism and sensitivities are available to direct therapy.
- If known HSV exposure, seizures, or severe illness: acyclovir 20 mg/kg IV Q8h with IVF, perform HSV work-up (see box), and consult pediatrics.
- If suspicion for bacterial meningitis, strongly consider medevac.
- If transferring patient, send any extra CSF on ice with patient.

This guideline is designed for the general use of most patients but may need to be adapted to meet the special needs of a specific patient as determined by the medical practitioner.
Approved by MSEC 5/8/19.
If comments about this guideline, please contact Leslie_Herrmann@ykhc.org.

Croup/Stridor: Evaluation & Treatment

MSEC Approved 7/12/17

Signs of Impending Airway Compromise
 -drooling
 -lethargy
 -tripod position
 -marked retractions
 -tachycardia
 -cyanosis or pallor
 -rapid progression of symptoms

Important Supportive Measures
 1. Keep child upright.
 2. May take child outside for cool air.
 3. Minimize invasive measures – keep child CALM!
 4. Do NOT give albuterol; this can worsen croup.

DDx Stridor
 -croup (most common in ages 6 months to 3 years)
 -foreign body
 -tracheomalacia
 -angioedema
 -tracheitis
 -epiglottitis
 -abscess

In Village
 If no racemic epinephrine available, mix 1 mL of 1:1000 epi with 1 bullet of NS and give via nebulizer.

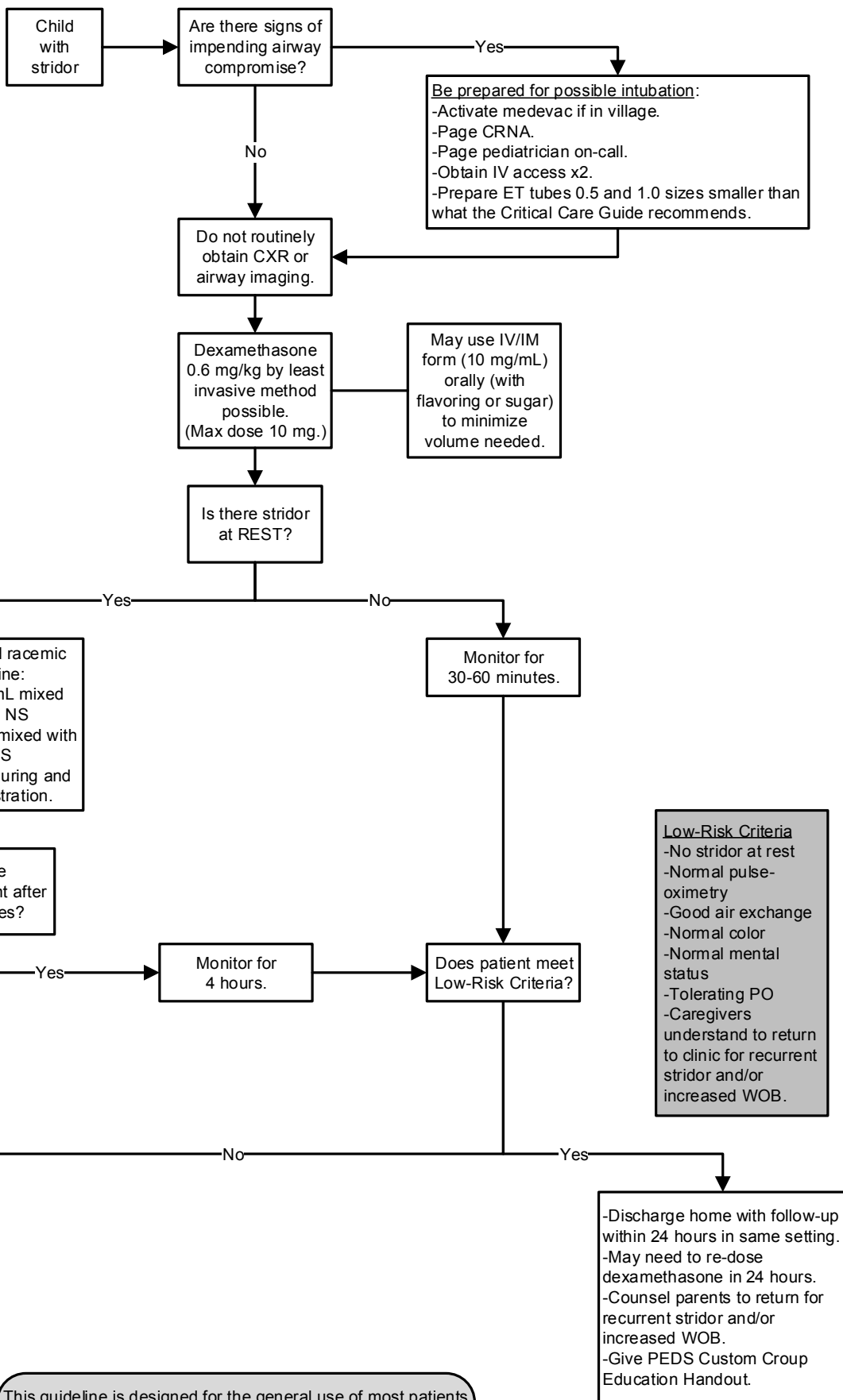

This guideline is designed for the general use of most patients but may need to be adapted to meet the special needs of a specific patient as determined by the medical practitioner.

Bronchiolitis / Wheezing – 3-24 Months

MSEC Approved 5/8/19

NOTE:

- If <3 months or history of prematurity, keep patient in Bethel and have low threshold for admission.
- RSV increases risk of apnea in these patients.
- If patient is <90 days and febrile, please see fever guidelines.

SUPPORTIVE MEASURES

- Control fever, as it can be an independent cause of respiratory distress and tachycardia.
- Nasal suction with nasal bulb syringe and olive tip plus saline.
- Hydration by IV or enteral (including NG and G-tube).
- Gentle P&PD/CPT if helpful.
- Saline neb (either 0.9% or hypertonic 3%).
- Consider albuterol trial even if no wheezing heard, especially in Alaska Native patients as they have high rates of RAD.

Village Management

- Institute **SUPPORTIVE MEASURES**, especially fever control, nasal suction, IV or PO hydration, and several albuterol nebs.
- Have low threshold to refer to Bethel for further evaluation if no improvement with supportive measures or any concerns.
- If no improvement after 2-3 days of village management, refer to Bethel for further care.
- If unable to bring to Bethel and worsening, consult a pediatrician and consider systemic steroids.

NOTE ABOUT STEROIDS:

National guidelines recommend against systemic steroids as the potential harm is generally greater than the potential benefit.

If considering starting steroids, please consult a pediatrician.

Hypoxia

<90% while awake
<88% while asleep
Sustained for >10 minutes

Pulse-Oximetry Monitoring:

- Pulse-ox may be ordered Q4h (not continuously) if age >6 months and patient is stable.
- Being on oxygen does not mandate continuous pulse-oximetry if patient is stable.

When Admitting, Use Power Plan to Order:

- IVF
- Nasal suction
- Nebs prn
- Consider scheduled nebs
- No deep (nasopharyngeal) suctioning
- Respiratory assessments
- Consider hypertonic (3%) saline – may need to use with albuterol

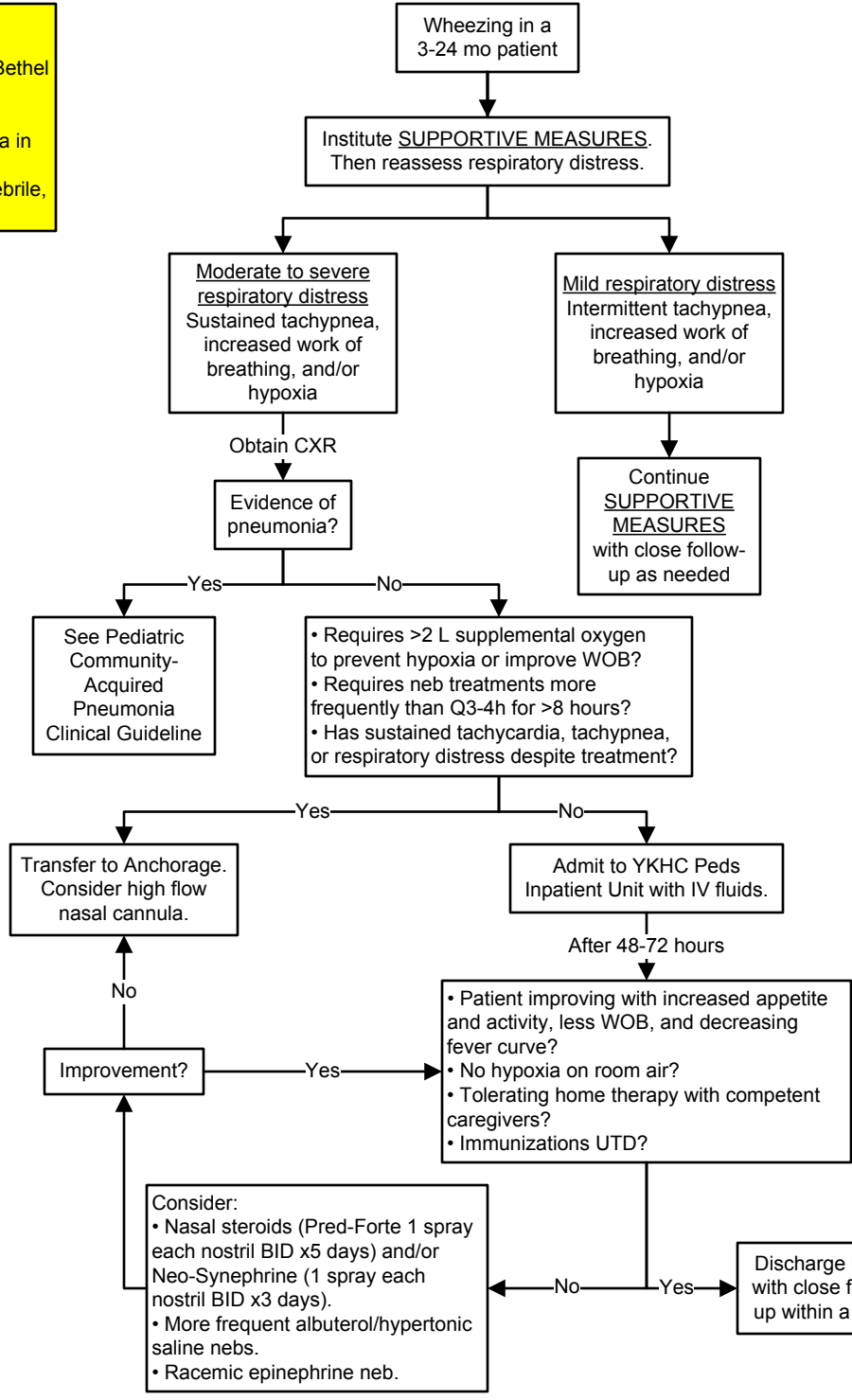

This guideline is designed for the general use of most patients but may need to be adapted to meet the special needs of a specific patient as determined by the medical practitioner.

Approved by MSEC 5/8/19.

If comments about this guideline, please contact Leslie_Herrmann@ykhc.org.

Pneumonia – Pediatric > 3 Months

MSEC Approved 5/8/19

REMEMBER:

- If patient is <90 days and febrile, please see fever guidelines.
- Pneumonia is a clinical diagnosis and does not require X-ray findings.

Hypoxia

<90% while awake
<88% while asleep
Sustained for >10 minutes

Pulse-Oximetry Monitoring:

- Pulse-ox may be ordered Q4h (not continuously) if age >6 months and patient is stable.
- Being on oxygen does not mandate continuous pulse-oximetry if patient is stable.

SUPPORTIVE MEASURES

- Control fever, as it can be an independent cause of respiratory distress and tachycardia.
- Nasal suction with nasal bulb syringe and olive tip plus saline.
- Hydration by IV or enteral (including NG and G-tube).
- Gentle P&PD/CPT if helpful.
- Saline neb (either 0.9% or hypertonic 3%).
- Consider albuterol trial, especially in Alaska Native patients as they have high rates of RAD.

Village Management

- Any child <5 years with suspected pneumonia should be evaluated in Bethel or an SRC.

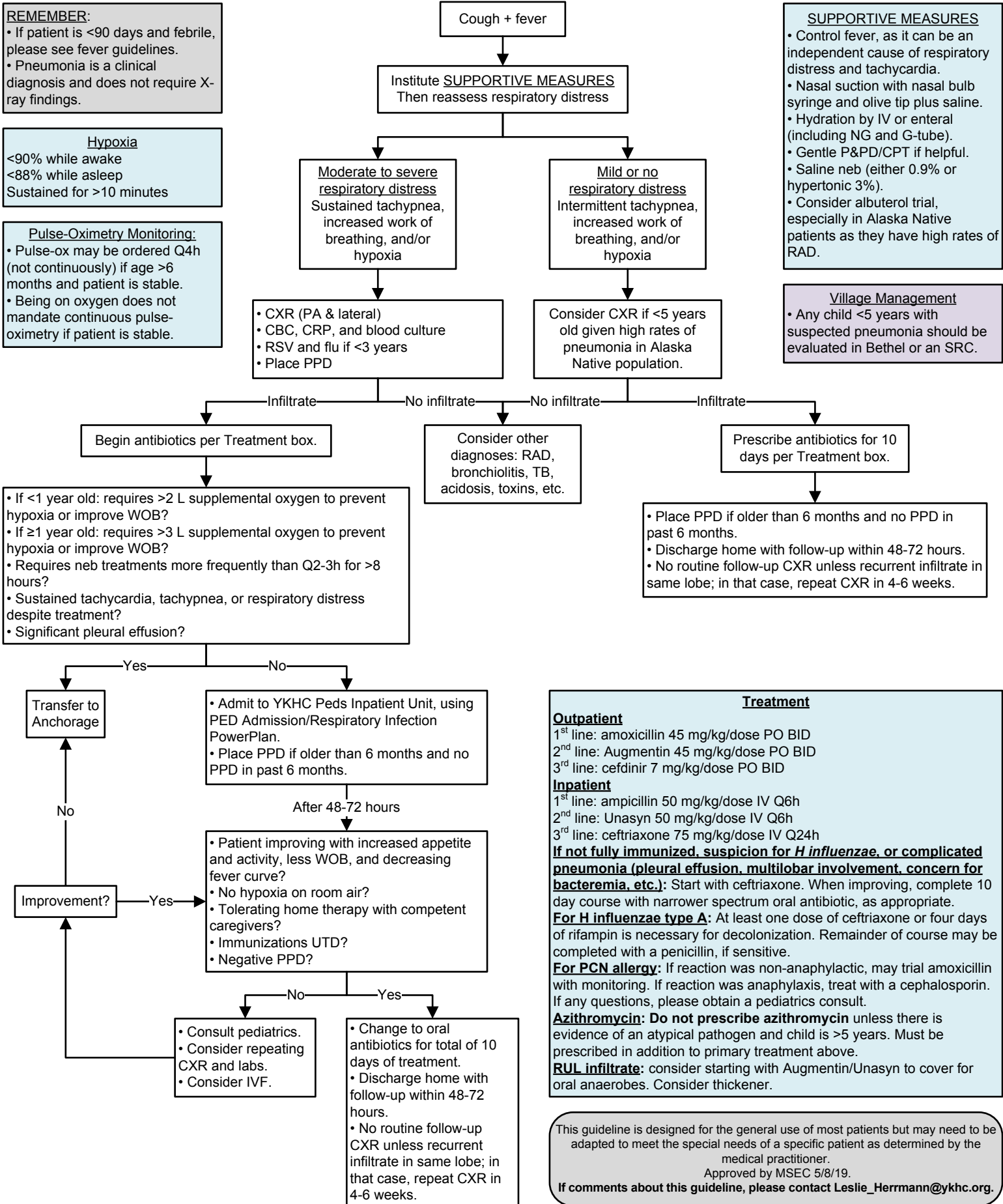

Treatment

Outpatient

1st line: amoxicillin 45 mg/kg/dose PO BID
2nd line: Augmentin 45 mg/kg/dose PO BID
3rd line: cefdinir 7 mg/kg/dose PO BID

Inpatient

1st line: ampicillin 50 mg/kg/dose IV Q6h
2nd line: Unasyn 50 mg/kg/dose IV Q6h
3rd line: ceftriaxone 75 mg/kg/dose IV Q24h

If not fully immunized, suspicion for H influenzae, or complicated pneumonia (pleural effusion, multilobar involvement, concern for bacteremia, etc.): Start with ceftriaxone. When improving, complete 10 day course with narrower spectrum oral antibiotic, as appropriate.

For H influenzae type A: At least one dose of ceftriaxone or four days of rifampin is necessary for decolonization. Remainder of course may be completed with a penicillin, if sensitive.

For PCN allergy: If reaction was non-anaphylactic, may trial amoxicillin with monitoring. If reaction was anaphylaxis, treat with a cephalosporin. If any questions, please obtain a pediatrics consult.

Azithromycin: Do not prescribe azithromycin unless there is evidence of an atypical pathogen and child is >5 years. Must be prescribed in addition to primary treatment above.

RUL infiltrate: consider starting with Augmentin/Unasyn to cover for oral anaerobes. Consider thickener.

This guideline is designed for the general use of most patients but may need to be adapted to meet the special needs of a specific patient as determined by the medical practitioner.

Approved by MSEC 5/8/19.

If comments about this guideline, please contact Leslie_Herrmann@ykhc.org.

Suspected Child Sexual Abuse Procedure

MSEC Approved 6/5/19

Indicators of Abuse: History

- No/vague explanation of significant injury
- Important details of explanation change dramatically
- Explanation of injury is inconsistent with the child's physical and/or developmental capabilities
- Injury occurred as a result of inadequate supervision
- Delay in seeking medical care without reasonable explanation
- Children with injuries resulting from family/ domestic violence incident
- Previous history of inflicted injury
- Inappropriate caretaker behavior that places child at risk

Indicators of Abuse: Physical Exam

Bruising

- Bruising in infants < 6months of age or non-ambulatory infants
- Bruising in unusual locations in any age child: ear pinna, neck, under chin, torso, buttock
- Pattern Bruises: loop marks, hand print, subgaleal hematoma due to hair pulling

Bite Marks

- Semi-circular/oval pattern
- May have associated bruising

Burns

- Pattern contact burns
- Cigarette burns
- Stocking/glove pattern
- Mirror image burns on extremities
- Symmetrical burns on buttock
- Immersion burns

Facial Injury

- Unexplained torn frenulum in non-ambulatory child
- Unexplained oral injury
- Ear injury

Injuries Suggestive of Abuse

Skeletal

- Rib fractures
- Multiple fractures
- Long bone fractures in < 6 months
- Any fracture (including femur) in non-ambulatory child
- Scapular fracture
- Sternum fracture
- Fractures of hands and feet

Head

- Subdural hematoma with or without skull fracture
- Unexplained intracranial injury (Note: Infants with intracranial injuries frequently have no or non-specific symptoms)

Poisoning

- Any illegal drug exposure, prescribed controlled substance, ethanol or marijuana

This guideline is designed for the general use of most patients but may need to be adapted to meet the special needs of a specific patient as determined by the medical practitioner.

Suspicion, allegation, disclosure, or confession of child physical abuse.
Please see Indicators of Abuse AND Injuries Suggestive of Abuse

Treat any acute issues as medically appropriate. If patient is in village and stable please arrange to have patient sent to ER via next commercial flight. If unstable then activate MedEvac.

Mandatory reporters must report via phone to: **OCS** AND law enforcement (**AST** if incident occurred in village or **BPD** if incident occurred in Bethel)

Complete Non-Accidental Trauma (NAT) Work-up

- Skeletal Survey .(See Box)
- CT Head if <6 months, symptomatic, or evidence of Closed Head Injury
- Laboratory Testing for Occult Injuries (See Box)
- Take photos of any injury visible on exam, especially bruising. Take a photograph of the injury at a distance, followed up by a close-up photo to establish relative size and landmarks.

Send RAVEN communication to Child Abuse Pool detailing reports made to Law Enforcement and **OCS**. May contact **Child Abuse On-Call** via TigerText if any questions or concerns.

If unable to reach a discharge plan with OCS that YOU think is safe, then consider admission for safety and TigerText **Child Abuse On-Call** to help reach a safe discharge plan.

Obtain Skeletal Survey For:

Children 0-24 months if concerns for child abuse or any of the following are present:

- History of confessed abuse
- Injury occurred during domestic violence
- Report of impact from toy/object causing fracture
- Delay in seeking care >24 hours in child with signs of distress
- Additional injuries unrelated to chief complaint (i.e. bruising, burns)
- No history of trauma to explain fracture, However, it is not necessary to get **skeletal survey** in ambulatory patients >12 months with distal buckle fracture of radius/ulna or distal spiral or buckle fracture of the tibia/ fibula

ALL children 0-11 months with any type of fracture except the following:

- Distal radial/ulna fracture or spiral fracture of the tibia/fibula (Toddler fracture) in a cruising child > 9 months with history of fall
- Linear, unilateral skull fracture in child >6 months with history of significant fall (fall from height > 3 feet or fall with caregiver landing on child)
- Clavicle fracture likely attributed to birth (acute fracture in infants <22 days old or healing fracture in infant <30 days old)

Children 0-24 months with any of the following fractures:

- Rib fracture
- Complex or ping pong skull fracture
- Humeral fracture with epiphyseal separation attributed to short fall (< 3 feet)
- Femur diaphyseal fracture attributed to fall from any height

Contacts

- Child Abuse On-Call via TigerText
- Office of Children's Services (**OCS**): (800) 478-4444
- Alaska State Troopers (**AST**): (907) 543-2294
- Bethel Police Department (**BPD**): (907) 543-3781
- Alaska CARES: (907) 561-8301

Mandatory Reporters include: Medical providers, nurses, health aides, teachers, social workers, law enforcement officers, and mental health professionals.

Report should be made by every mandated reporter who has a concern - even if you think a report has already been made. This helps keep reports up to date with new information.

Laboratory Testing for Occult Injuries

All Patients ≤ 7 years or >7 if clinically indicated

- CBC
- CMP
- Amylase/Lipase
- UA

Fractures

- Above labs and Magnesium & Phosphorus

Bruising or Intracranial Hemorrhage

- Above labs plus PT/PTT
- If patient needs blood, obtain vWF (von Willebrand) antigen and activity, Factor VII and IX

Altered Mental Status/Drug Ingestion

- Urine Drug Screen
- Ethanol level
- Tylenol level
- Aspirin level

Head Injury/Concussion <18 Years

MSEC Approved 5/8/19

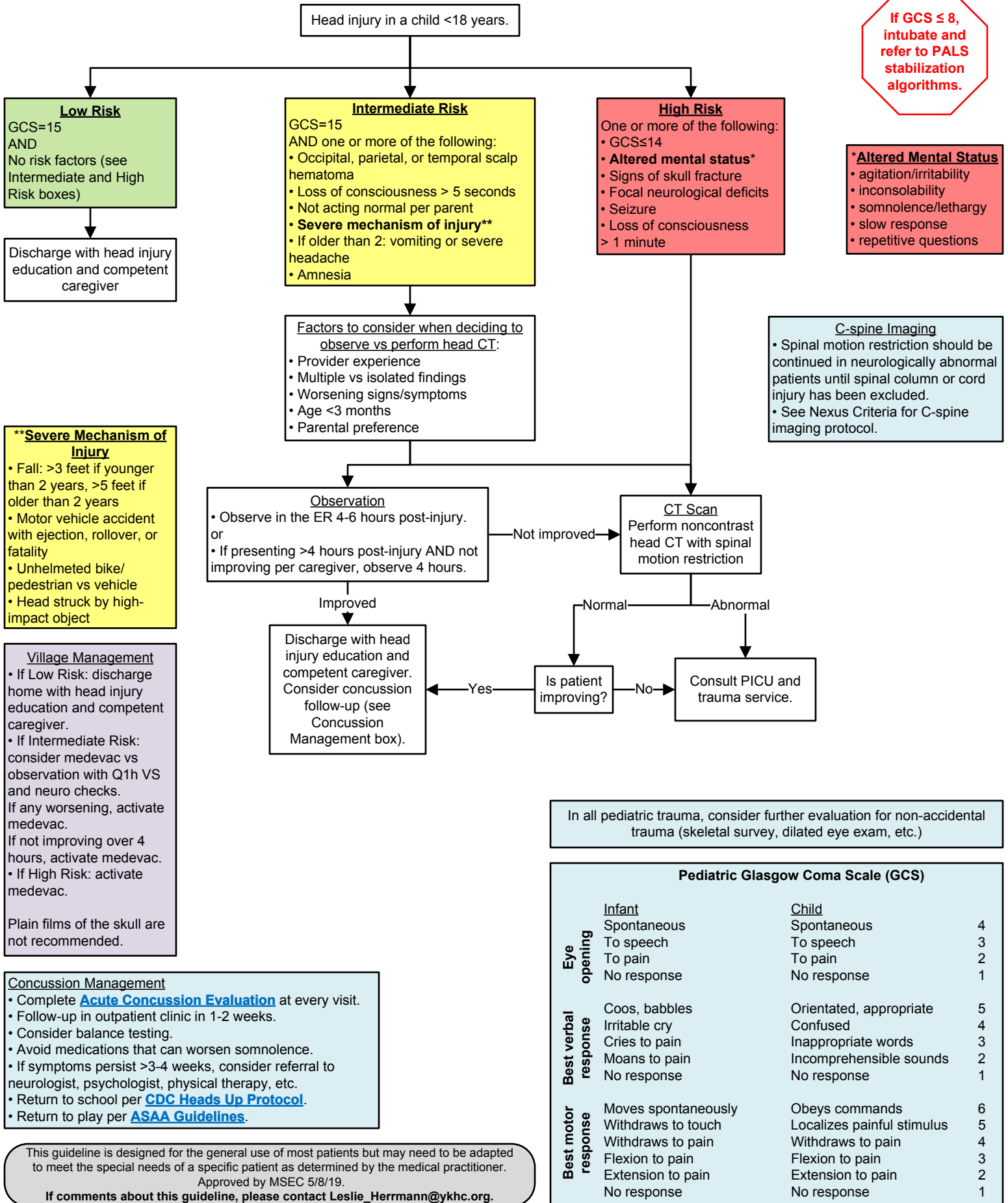

Amoxicillin Allergy Trials

MSEC approved 5/8/19

Background

- Only 4-9% of those...labeled [penicillin-allergic] are currently allergic. It is important to identify those who are not allergic, because children mislabeled as penicillin-allergic have more medical visits, receive more antibiotic prescriptions, and have longer hospitalizations with more antibiotic-related complications.¹
- Up to 10% of children develop rashes while receiving antibiotics. Most are diagnosed...as allergic to the implicated antibiotic, and most continue to avoid the suspect antibiotic in favor of alternatives, which may be less effective, more toxic, and more expensive.²
- Do not label a patient as allergic to penicillin/amoxicillin unless he or she has true hives, anaphylaxis, or a life-threatening reaction. Please include photos of rashes in RAVEN.
- Please consult a pediatrician with any questions.

Anaphylaxis

- Acute onset – several minutes to hours from exposure.
- Generalized hives, pruritis or flushing, swelling of lips/tongue/uvula, and at least one of the following:
 - Dyspnea, bronchospasm, stridor
 - Hypotension
 - Evidence of hypoperfusion of end-organs
 - Persistent crampy abdominal pain and/or vomiting

Hives vs Viral Rash

- True hives are raised, itchy, larger than dime-sized, come and go, move around the body, and change shape and size.
- Keep in mind that many parents refer to any rash as "hives." Get a description every time.
- A viral exanthem is typically diffuse, fine, pinpoint red dots and can be dense, coalesced, larger raised lesions. The rash typically covers the face and chest but can cover the whole body. The rash typically worsens and takes days to clear.

References

1. Kelso JM. "Provocation challenges to evaluate amoxicillin allergy in children." JAMA Pediatrics 2016;170(6):e160282.
2. Mill C, et al. "Assessing the diagnostic properties of a graded oral provocation challenge for the diagnosis of immediate and nonimmediate reactions to amoxicillin in children." JAMA Pediatrics. 2016;170(6):e160033.

History

Chart review:

- Review notes in allergy alert. Find date allergy was added, and then review notes from that day.
- Look in Multimedia Manager for photos.
- Has patient received a drug of the same class since the allergy was reported?

History from patient/family:

- What was the reaction?
 - Vomiting and/or diarrhea? Rash?
 - Age? Time from first dose? Hives? (See box.)
 - Photos from family? Trouble breathing? Swelling of tongue/lips?

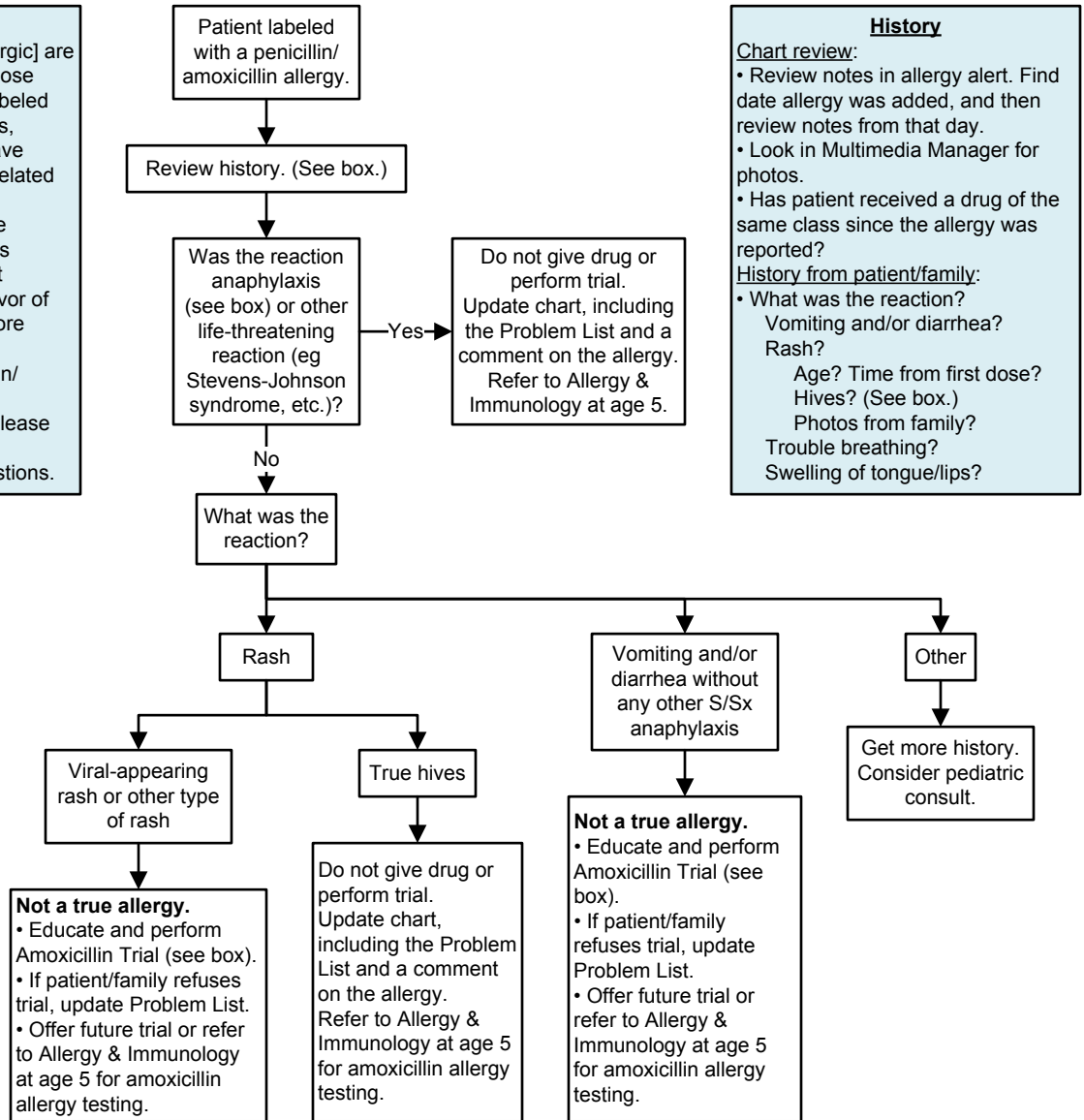

Amoxicillin Trial Procedure²

1. Obtain VS. Perform physical exam, including lung exam. Have appropriate dose of EpiPen or epinephrine available.
Epinephrine (1 mg/mL): 0.01 mg/kg (or 0.01 mL/kg) IM q5-15 minutes.
Per AAP recommendations:
 - 7.5-25 kg: use EpiPen Jr (0.15 mg)
 - ≥ 25 kg: use EpiPen (0.3 mg)
2. Calculate weight-based dose of amoxicillin. Give patient 10% of that dose.
3. Place patient in nearby room and instruct caregiver to notify staff of any changes in status.
4. If no reaction by 20 minutes, give patient remaining 90% of weight-based dose of amoxicillin.
5. Observe another 60 minutes. If no reaction, check VS and physical exam. If all stable, discharge home with regular course of drug.
6. Give patient and family amoxicillin trial education sheet.
7. Update allergy alert in RAVEN. Click the allergy in the banner. Right click over the drug name and choose "cancel." On the "reason" drop-down menu, choose "OK on Retrial."

This guideline is designed for the general use of most patients but may need to be adapted to meet the special needs of a specific patient as determined by the medical practitioner.
Approved by MSEC 5/8/19.
If comments about this guideline, please contact Jane_McClure@ykhc.org.

CLINICAL GUIDELINES

2019

rev. 06-27-19

Pediatric Outpatient Guidelines

UTI – Children 3 Months–5 Years.....	47
Otitis Media 3 Months–12 Years.....	48
Sinusitis > 5 Years.....	49
Attention Deficit Hyperactivity Disorder in Children.....	50
TB Evaluation & Treatment – Pediatric.....	51
Seizure Evaluation – Pediatric.....	52
Chronic Cough/Bronchiectasis – Pediatrics.....	53
Lead Evaluation – Pediatrics.....	54
Acute Cervical Lymphadenitis	
Evaluation & Treatment – Pediatrics.....	55
Amoxicillin Allergy Trials.....	56

UTI – Children 3 Months–5 Years

MSEC Approved 5/8/19

Signs and Symptoms of UTI

- fever
- dysuria
- vomiting
- abdominal pain
- new daytime or nighttime wetting
- increased frequency of voiding
- malodorous urine

Differential Dx for Dysuria

- UTI
- vulvovaginitis
- Candida infection
- poor hygiene
- sexual abuse
- age-appropriate self-exploration

Resistance

- Empiric drug choice is based on local resistance patterns and consultation with ID specialist.
- If urine culture grows an Extended-Spectrum Beta-Lactamase (ESBL) producing organism, please obtain a pediatrics consult and add ESBL to Problem List.

Indications for VCUG:

- Recurrent UTI in child <6 years. Note: study available in Bethel 1-2 times per year when radiologist in-house.
- Major anomaly on ultrasound. Consult pediatric urologist and consider obtaining VCUG in Anchorage.

Symptomatic Care

- If dysuria, irritation, etc. recommend A+D ointment and instruct family to do soaks/baths with warm water and no soap.
- May consider baking soda ¼ cup per tub.

Village Management

- Do not treat any child under 5 years of age empirically in the village.
- If patient has dysuria, increased frequency, new-onset enuresis, and/or abnormal clean catch urinalysis, consider further evaluation in Bethel.
- Consider symptomatic care (see box) for possible vulvovaginitis.

DO NOT ...

- treat any child under 5 years of age empirically in the village.
- routinely collect urine via bag.
- treat a UTI without a culture in progress.
- routinely perform a test of cure.
- routinely start UTI prophylaxis.
- perform suprapubic taps.
- routinely obtain bloodwork for uncomplicated UTI.
- add UTI to Problem List until confirmed by culture.

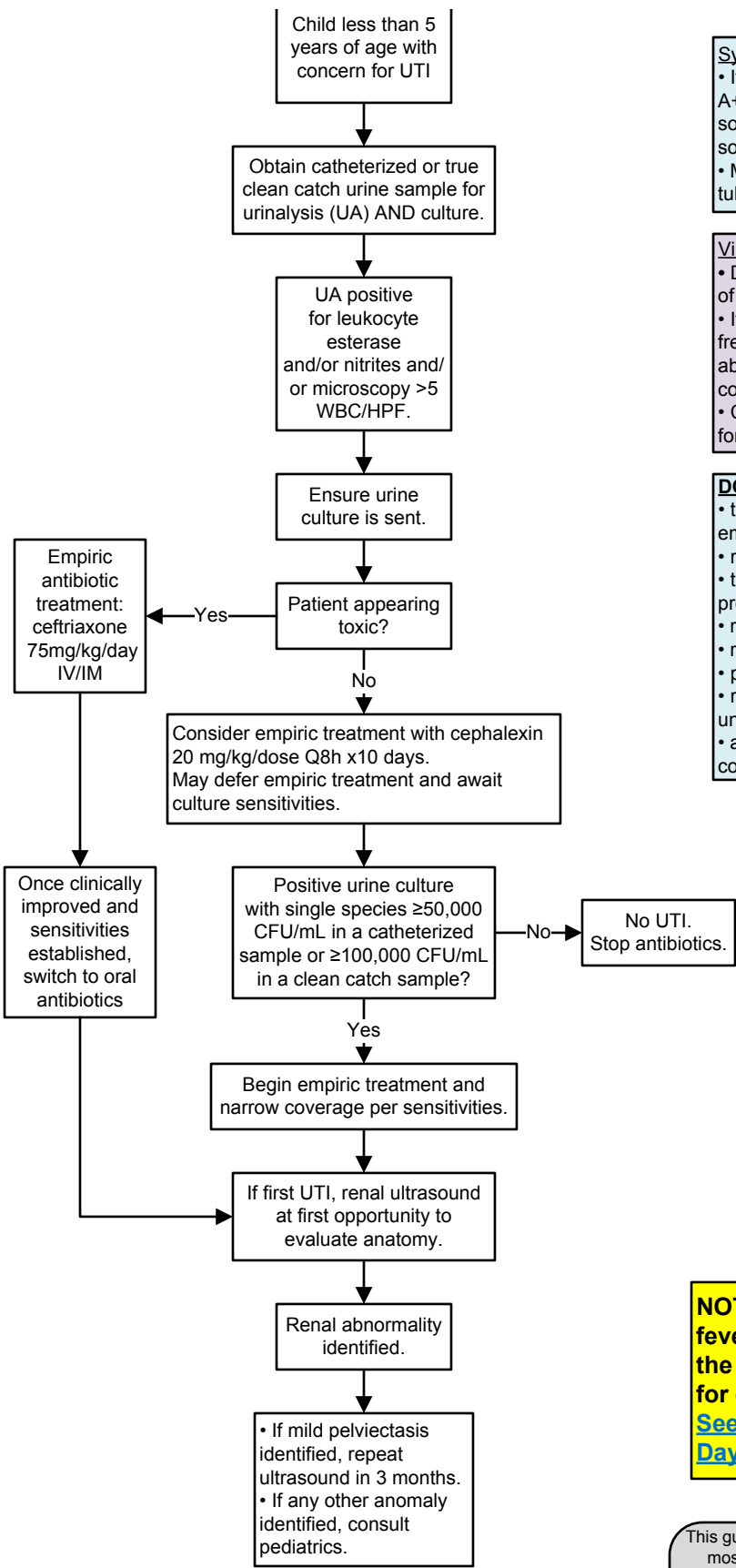

NOTE: Any infant with a fever <90 days must go to the Emergency Department for evaluation.
[See the Fever in Infants 0-90 Days Guideline.](#)

This guideline is designed for the general use of most patients but may need to be adapted to meet the special needs of a specific patient as determined by the medical practitioner.
 Approved by MSEC 5/8/19.
 If comments about this guideline, please contact Leslie_Herrmann@ykhc.org.

Otitis Media 3 Months–12 Years

MSEC Approved 4/26/18

Box 1: AOM Decision-Making Principles

- Try not to give antibiotics if observation is warranted.
- Always treat pain.
- If patient has not received amoxicillin within 30 days, start with amoxicillin to treat new infection.
- For AOM with otorrhea, use otic drops if >6 months. Do not use oral antibiotics unless the other ear is infected without perforation.
- Do not treat fluid that develops after AOM if child is asymptomatic – observe up to 3 months.
- Do not use azithromycin, erythromycin, cephalexin (Keflex), or Septra for AOM.
- Do not use antibiotic prophylaxis.
- Do not send ear drainage for culture.

AOM ≥3 months

Acute onset of:

- Fever and ear pain
- Bulging TM and decreased mobility

See Box 1.

AOM <3 Months Old

If suspecting AOM <3 months old, patient must be seen by provider within 24 hours.

- ≤28 days old: patient must be seen in the ER for full lab work-up including LP and treatment with IV antibiotics.
- 29-60 days old with or without fever, patient must be seen in the ER for full lab work-up including LP.
 - If febrile, follow fever < 90 days clinical guideline.
 - If afebrile and reassuring work-up, may treat with oral antibiotics as appropriate.
- 61-90 days old:
 - If febrile, follow fever < 90 days clinical guideline.
 - If afebrile and sick-appearing, perform work-up as clinically appropriate. May consult peds as needed.
 - If afebrile and well-appearing, lab work-up not necessary. May treat with oral or otic antibiotics as appropriate.

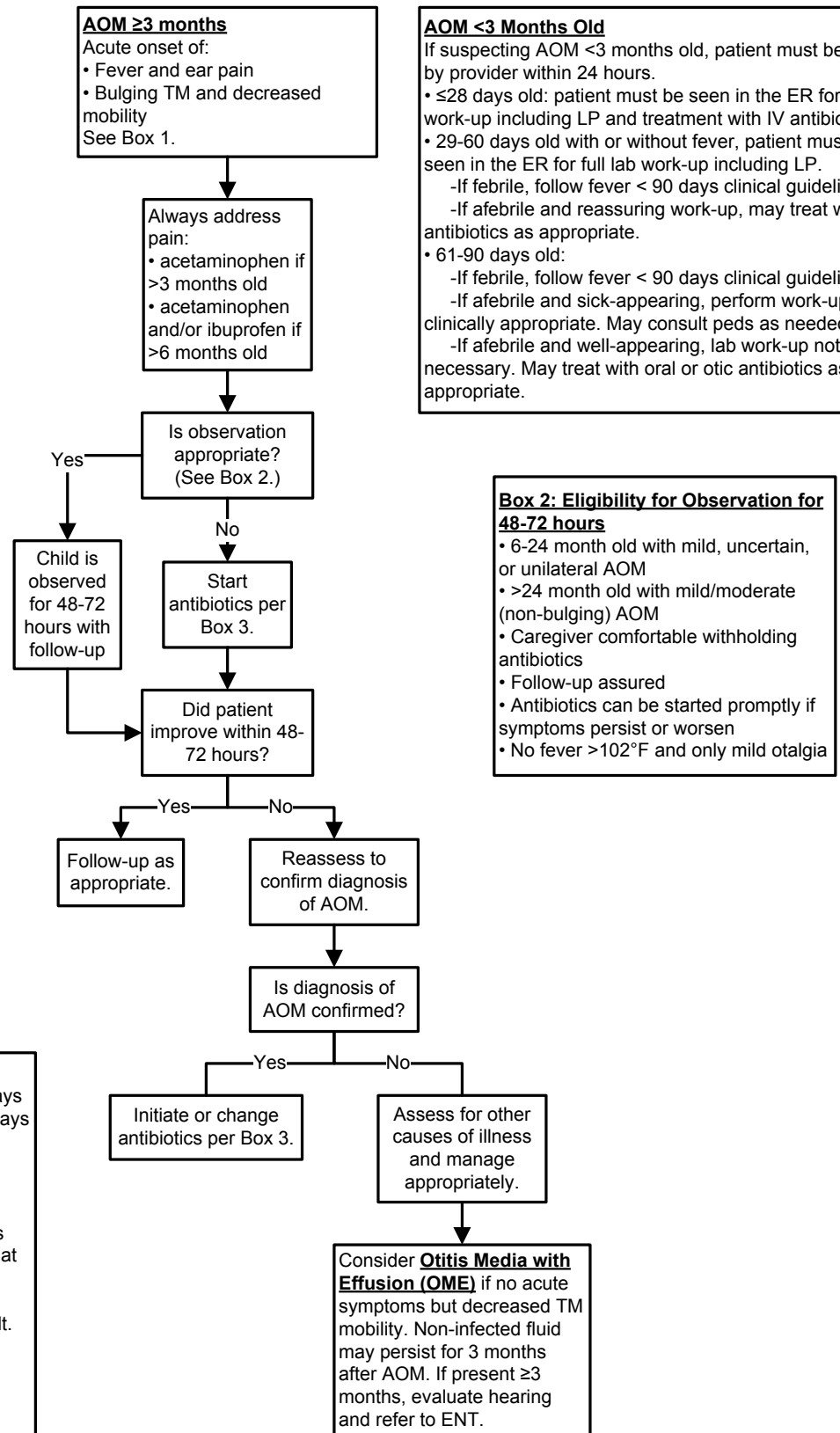

Box 2: Eligibility for Observation for 48-72 hours

- 6-24 month old with mild, uncertain, or unilateral AOM
- >24 month old with mild/moderate (non-bulging) AOM
- Caregiver comfortable withholding antibiotics
- Follow-up assured
- Antibiotics can be started promptly if symptoms persist or worsen
- No fever >102°F and only mild otalgia

Box 3: AOM Treatment

- 1st line: amoxicillin 45 mg/kg/dose PO BID for 10 days
 2nd line: Augmentin 45 mg/kg/dose PO BID for 10 days
 3rd line: cefdinir 7 mg/kg/dose PO BID for 10 days
 4th line: ceftriaxone 75 mg/kg IV/IM QD for 3 days

Otitis-conjunctivitis syndrome

Augmentin 45 mg/kg/dose PO BID for 10 days

Try to avoid using cephalosporins. They are less effective at treating the most common organisms that cause OM. Additionally, cefdinir takes 3-5 days to reach the villages.

For PCN allergy: Please obtain a pediatrics consult.

For ruptured TM/tube drainage:

- Wick ears prior to giving drops.
- Ofloxacin 3-5 drops BID x10 days
- Ciprofloxacin 3-5 drops BID x10 days

This guideline is designed for the general use of most patients but may need to be adapted to meet the special needs of a specific patient as determined by the medical practitioner.

When to Refer to ENT

- 3 episodes of AOM in 6 months
- 4 episodes of AOM in 12 months
- OME or otorrhea for ≥3 months
- Hearing loss >20 dB

Sinusitis > 5 Years

MSEC Approved 4/26/18

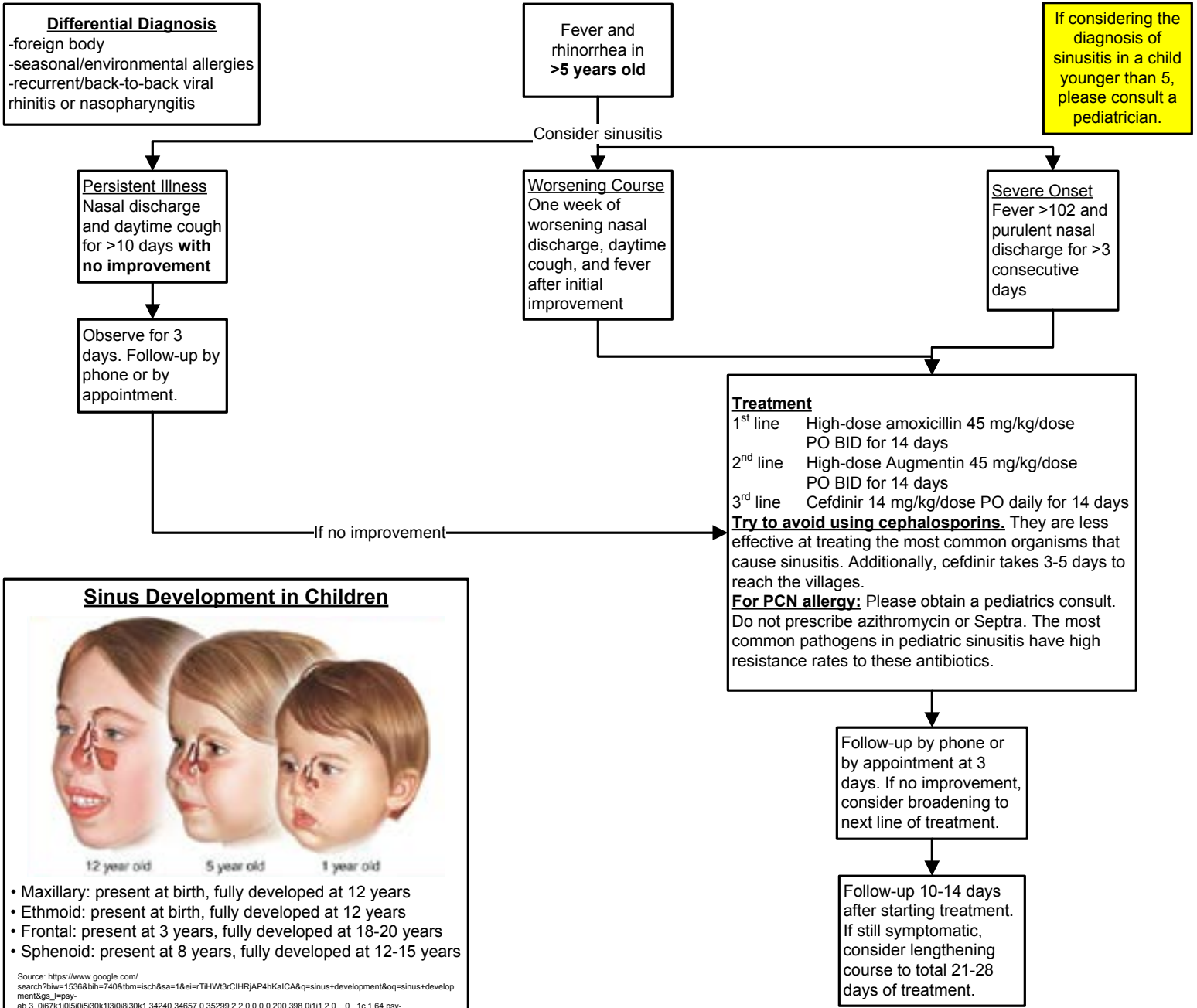

Sinus Development in Children

- Maxillary: present at birth, fully developed at 12 years
- Ethmoid: present at birth, fully developed at 12 years
- Frontal: present at 3 years, fully developed at 18-20 years
- Sphenoid: present at 8 years, fully developed at 12-15 years

Source: https://www.google.com/search?biw=1536&bih=740&tbm=isch&sa=1&ei=rTIHWt3rCIHRjAP4hKaICA&q=sinus+development&oeq=sinus+development&gs_l=psy-ab.3..0i67k1j0i5j0i530k1i3j0i830k1.34240.34657.0.35299.2.2.0.0.0.0.200.398.0j1j1.2.0...0...1c.1.64.psy-ab.0.2.395...030k1.0.rSFh1aHq74#imgrc=IDSBxCrF0AKW.M.&spfl=1518811500752

Imaging

Do not routinely obtain imaging studies in suspected sinusitis unless there is concern for a complication like orbital or CNS involvement.
Do not treat sinusitis, in the absence of symptoms, if it is an incidental finding on an imaging study.

Adjuvant Therapies

- Saline nasal spray
- Steam
- Oral hydration
- Tylenol and ibuprofen
- Do not routinely give decongestants and antihistamines (especially Benadryl). They have been proven ineffective in

This guideline is designed for the general use of most patients but may need to be adapted to meet the special needs of a specific patient as determined by the medical practitioner.

Attention Deficit Hyperactivity Disorder in Children

MSEC approved 07/12/17

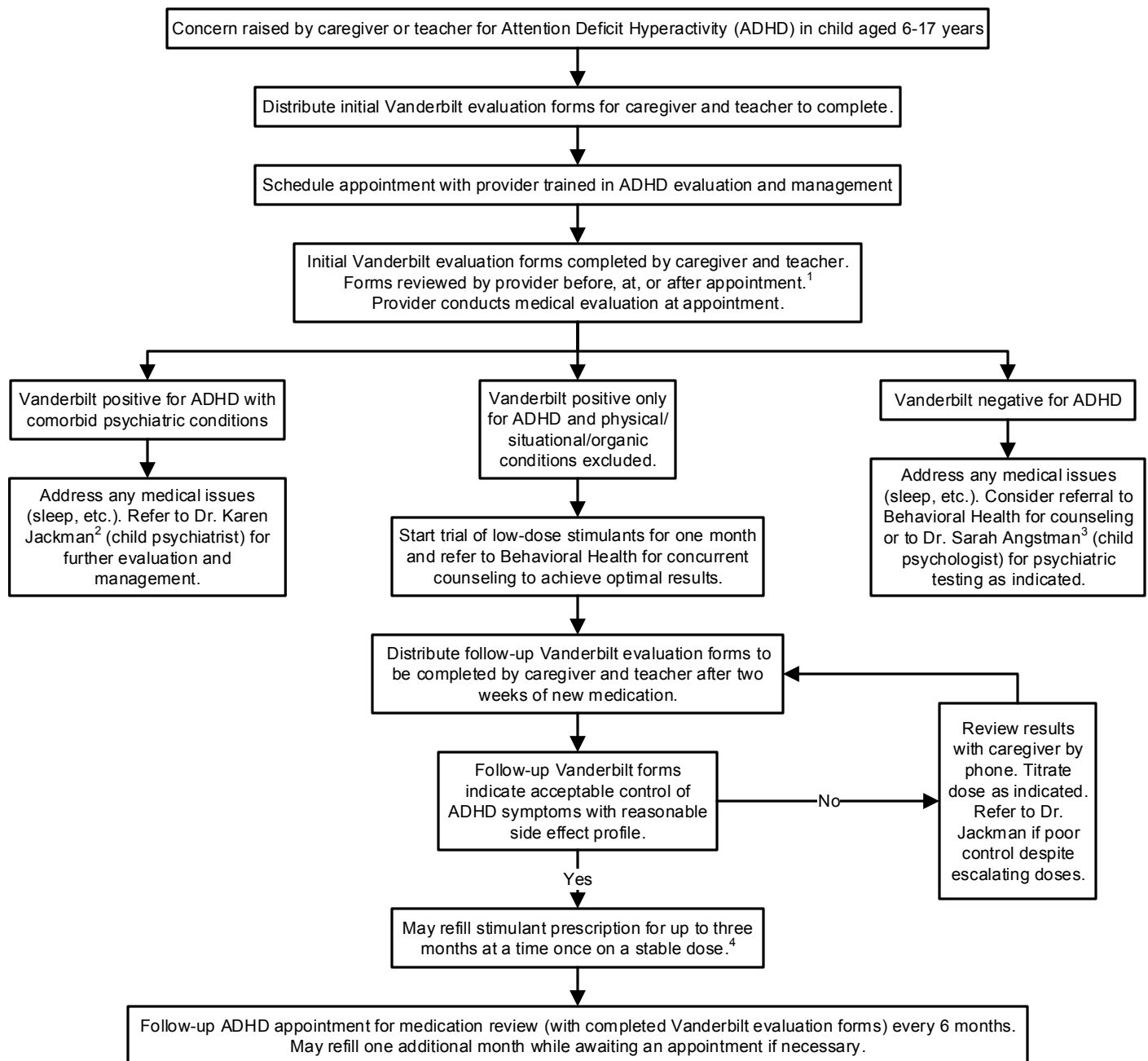

1. Scan completed Vanderbilt forms into MultiMedia Manager under "Continuity of Care."

2. Use "Refer to Peds Psychiatry Internal" order. Dr. Jackman may be contacted at (907) 230-3765 or jackman@alaska.net.

Her case manager is Patricia Sipary at ext 6466.

3. Use "Refer to Other External" order and send a message to the case manager to process the referral. Dr. Angstman may be contacted at (907) 545-5330.

4. Write three separate 30 day prescriptions. In the Special Instructions box of the two additional prescriptions, enter the earliest date the prescription may be filled (e.g. "Fill on/after 2/1" and "Fill on/after 3/1"). Bring the two additional prescriptions to case manager to be held until refill is requested by caregiver.

This guideline is designed for the general use of most patients but may need to be adapted to meet the special needs of a specific patient as determined by the medical practitioner.

TB Evaluation & Treatment – Pediatric

MSEC Approved 4/26/18 - minor revisions 07-26-18

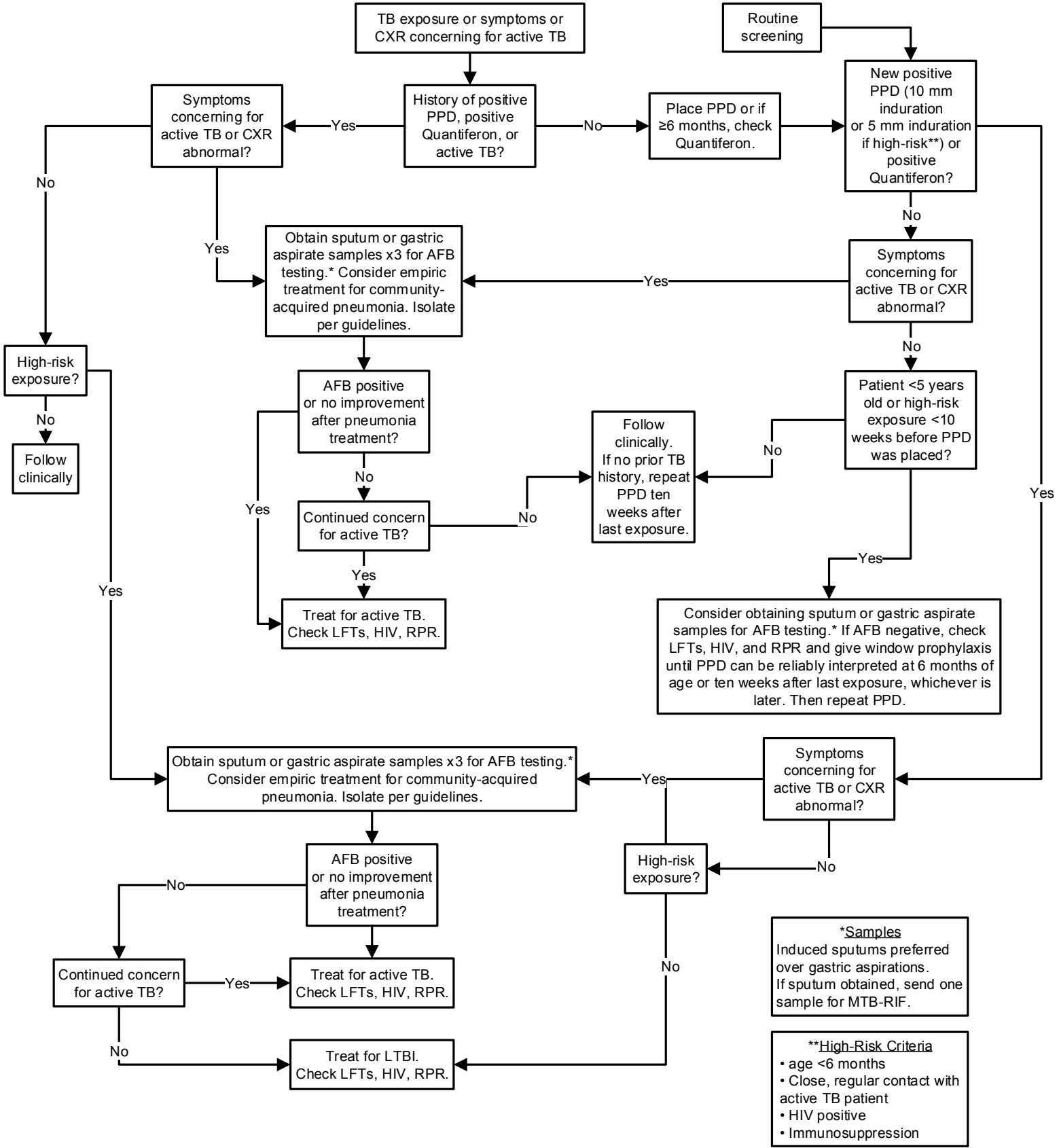

***Samples**
Induced sputums preferred over gastric aspirations. If sputum obtained, send one sample for MTB-RIF.

****High-Risk Criteria**

- age <6 months
- Close, regular contact with active TB patient
- HIV positive
- Immunosuppression

Abbreviations: TB- tuberculosis; CXR- chest X-ray; PPD- purified protein derivative; AFB- acid-fast bacilli; HIV- human immunodeficiency virus; LFTs- liver function tests

This guideline is designed for the general use of most patients but may need to be adapted to meet the special needs of a specific patient as determined by the medical practitioner.

Seizure Evaluation – Pediatric

MSEC approved 12/13/17

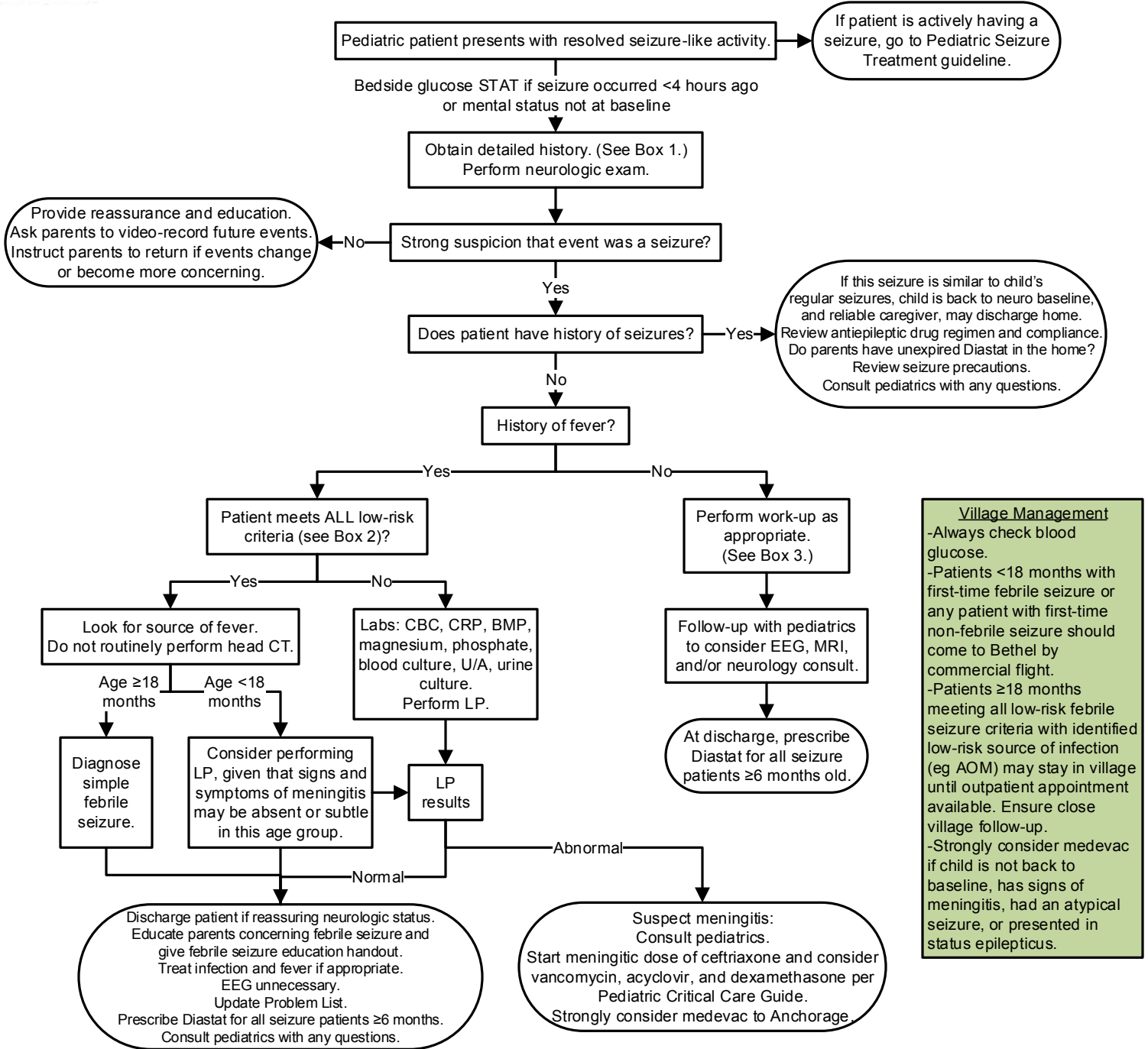

Village Management
 -Always check blood glucose.
 -Patients <18 months with first-time febrile seizure or any patient with first-time non-febrile seizure should come to Bethel by commercial flight.
 -Patients ≥18 months meeting all low-risk febrile seizure criteria with identified low-risk source of infection (eg AOM) may stay in village until outpatient appointment available. Ensure close village follow-up.
 -Strongly consider medevac if child is not back to baseline, has signs of meningitis, had an atypical seizure, or presented in status epilepticus.

Box 1: Detailed History
 -When/where did it occur? Awake or asleep?
 -What preceded the event (eg head trauma, crying, etc.)?
 -How long did it last?
 -Ask caregiver to recount, step-by-step, what happened.
 -Type of movement and what part of body? Symmetric?
 -Interventions?
 -Incontinence?
 -Behavior after event?
 -How long till back to baseline?
HPI
 -Intercurrent illness/fevers
 -Medications
 -Recent intake, including free water and diluted formula
 -Ingestions
 -Trauma
PMH
 -Prior history of seizures
 -History of breathholding
Family History
 Seizures, febrile seizures, breathholding, etc.

Box 2: Low risk febrile seizure criteria
 1. 6 months to 4 years of age.
 2. Fever present.
 3. Seizure generalized (nonfocal).
 4. Seizure duration <5 minutes.
 5. Child has normal neurologic examination.
 6. Child has no history of previous neurologic or CNS abnormality.
 7. Only one seizure in a 24 hour period.
 8. Child has returned to baseline.
 9. No meningeal signs:
 -Irritability or inconsolability
 -Nuchal rigidity
 -Bulging fontanelle
 -Lethargy or somnolence
 -Focal neurologic findings
 10. Child has NOT received antibiotics in the past 72 hours.

Box 3: Work-up
 -Bedside glucose
 -EKG for first event
 -BMP, magnesium, phosphate
 -Urine drug screen
 -Perform LP if persistent altered mental status, meningitis suspected, or <18 months of age and delayed return to baseline.
Radiological studies:
 -Obtain head CT prior to LP if concerning neurologic status, persistently altered mental status, history of trauma, or focal neurological findings.

This guideline is designed for the general use of most patients but may need to be adapted to meet the special needs of a specific patient as determined by the medical practitioner.

Chronic Cough/Bronchiectasis – Pediatrics

MSEC approved 12/13/17

Definitions

- Bronchiectasis is a lung condition with chronic wet cough and lung infections and is diagnosed by CT scan. Use ICD10 code J47 – “Bronchiectasis.”
- Bronchiectasis risk is defined as ≥3 episodes of wet cough >4 weeks in the past 2 years, often in a setting of persistent infiltrates and recurrent pneumonia. Use ICD10 code J41.1 – “Chronic purulent bronchitis.”

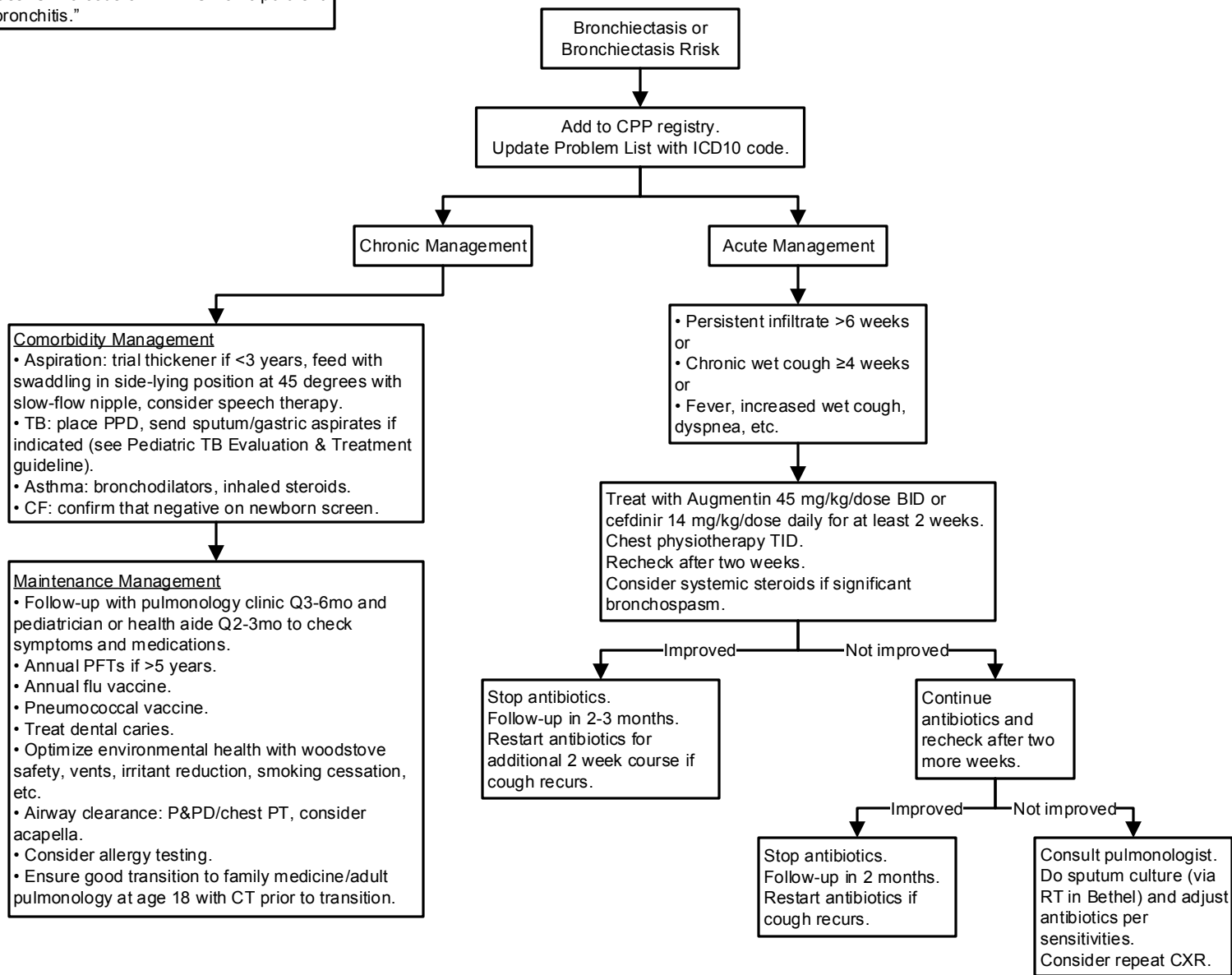

This guideline is designed for the general use of most patients but may need to be adapted to meet the special needs of a specific patient as determined by the medical practitioner.

Lead Evaluation – Pediatrics

MSEC approved 12/13/17

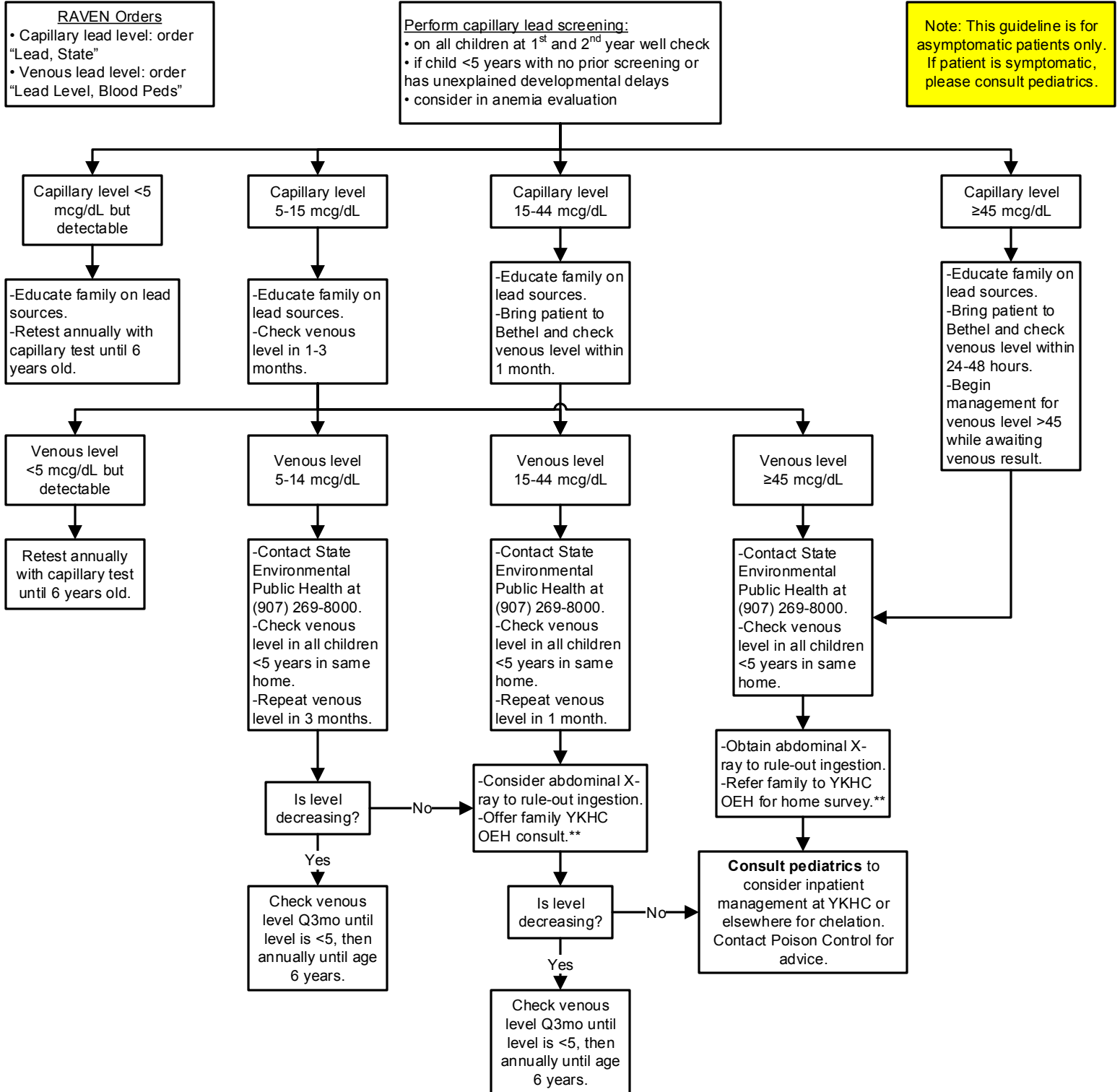

**To consult YK Office of Environmental Health (OEH), email Jennifer_Dobson@ykhc.org with patient's name and DOB, lead levels, and parent's contact information. OEH can review environmental risk factors with family and offer a home visit if appropriate.

This guideline is designed for the general use of most patients but may need to be adapted to meet the special needs of a specific patient as determined by the medical practitioner.

Acute Cervical Lymphadenitis Evaluation & Treatment – Pediatrics

MSEC approved 12/13/17

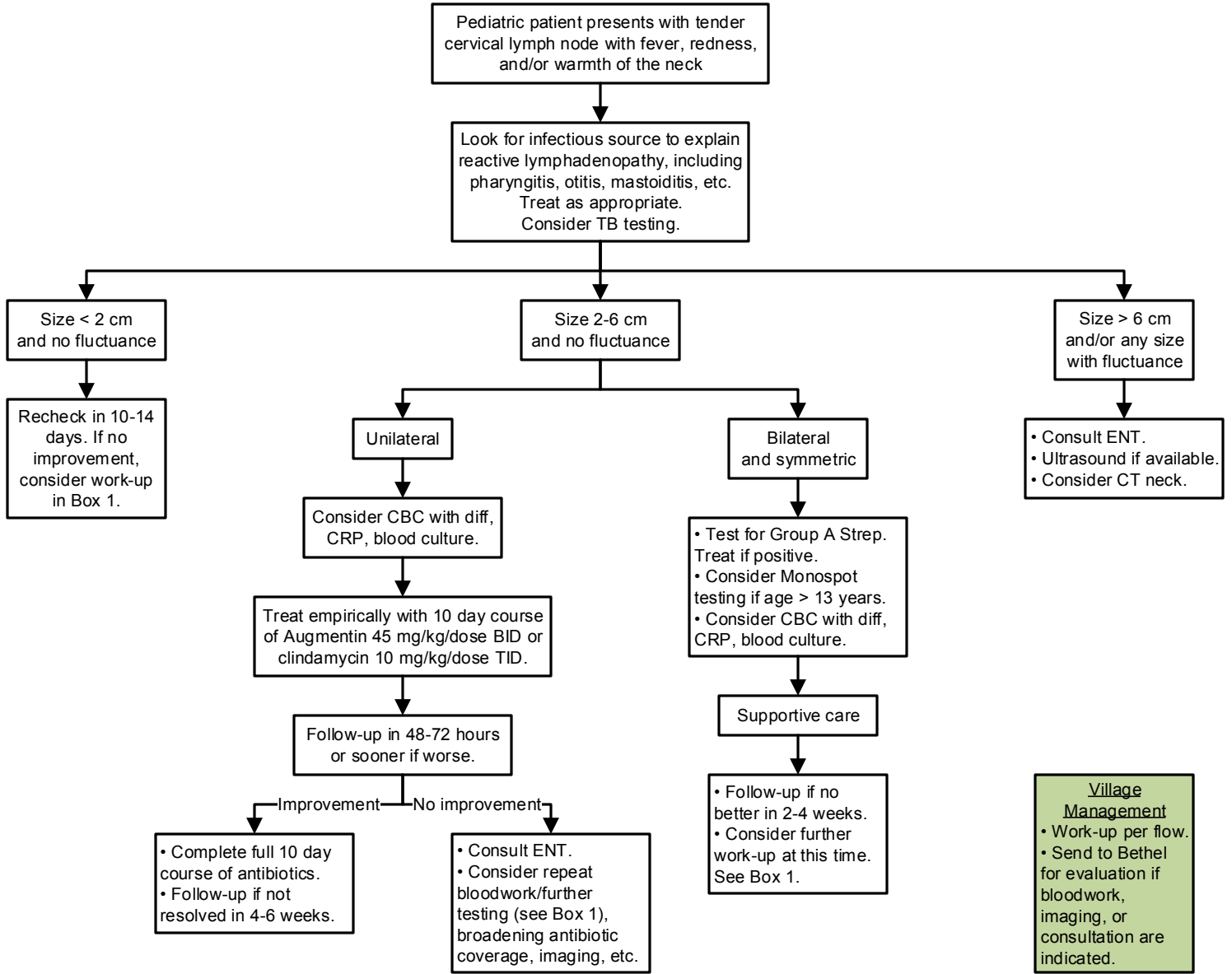

Box 1: Further Work-up
 Perform careful exam for lymphadenopathy of other locations. For any child with nontender lymphadenopathy or lack of improvement after specified period, consider, as appropriate:

- PPD/TB work-up
- CBC
- CRP
- LFTs
- Blood culture
- HIV testing
- RPR
- Toxoplasmosis testing
- Bartonella testing
- EBV, CMV titers
- LDH, uric acid
- CXR
- Hematology/oncology consult
- Infectious disease consult

Most Common Causes

- **Reactive lymphadenopathy** due to local infection (may take 4-6 weeks to resolve).
- **Unilateral:** *Staph aureus*, Group A Strep, Group B Strep, anaerobes, TB/MAC
- **Bilateral:** respiratory viruses (enterovirus, adenovirus, influenza, etc.), Group A Strep, HSV (primary), EBV, CMV, *Mycoplasma*, *Arcanobacterium*, TB

Less Common Causes to Consider

- Kawasaki disease; periodic fever with aphthous stomatitis, pharyngitis, and adenitis (PFAPA); leukemia; lymphoma

This guideline is designed for the general use of most patients but may need to be adapted to meet the special needs of a specific patient as determined by the medical practitioner.

Amoxicillin Allergy Trials

MSEC approved 5/18/19

Background

- Only 4-9% of those...labeled [penicillin-allergic] are currently allergic. It is important to identify those who are not allergic, because children mislabeled as penicillin-allergic have more medical visits, receive more antibiotic prescriptions, and have longer hospitalizations with more antibiotic-related complications.¹
- Up to 10% of children develop rashes while receiving antibiotics. Most are diagnosed...as allergic to the implicated antibiotic, and most continue to avoid the suspect antibiotic in favor of alternatives, which may be less effective, more toxic, and more expensive.²
- Do not label a patient as allergic to penicillin/amoxicillin unless he or she has true hives, anaphylaxis, or a life-threatening reaction. Please include photos of rashes in RAVEN.
- Please consult a pediatrician with any questions.

History

Chart review:

- Review notes in allergy alert. Find date allergy was added, and then review notes from that day.
- Look in Multimedia Manager for photos.
- Has patient received a drug of the same class since the allergy was reported?

History from patient/family:

- What was the reaction?
 - Vomiting and/or diarrhea?
 - Rash?
 - Age? Time from first dose?
 - Hives? (See box.)
 - Photos from family?
 - Trouble breathing?
 - Swelling of tongue/lips?

Anaphylaxis

- Acute onset – several minutes to hours from exposure.
- Generalized hives, pruritis or flushing, swelling of lips/tongue/uvula, and at least one of the following:
 - Dyspnea, bronchospasm, stridor
 - Hypotension
 - Evidence of hypoperfusion of end-organs
 - Persistent crampy abdominal pain and/or vomiting

Hives vs Viral Rash

- True hives are raised, itchy, larger than dime-sized, come and go, move around the body, and change shape and size.
- Keep in mind that many parents refer to any rash as “hives.” Get a description every time.
- A viral exanthem is typically diffuse, fine, pinpoint red dots and can be dense, coalesced, larger raised lesions. The rash typically covers the face and chest but can cover the whole body. The rash typically worsens and takes days to clear.

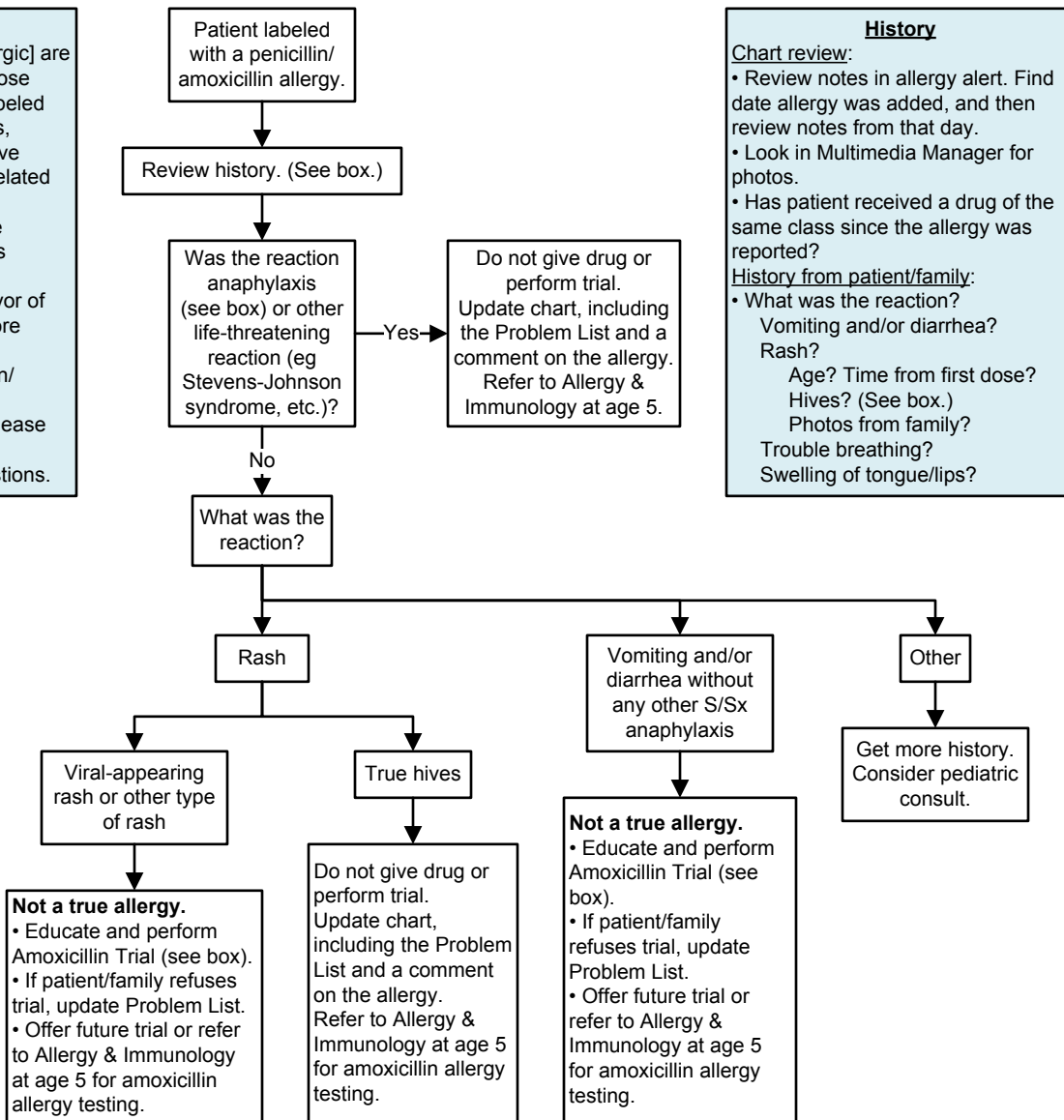

Amoxicillin Trial Procedure²

1. Obtain VS. Perform physical exam, including lung exam. Have appropriate dose of EpiPen or epinephrine available.
Epinephrine (1 mg/mL): 0.01 mg/kg (or 0.01 mL/kg) IM q5-15 minutes.
Per AAP recommendations:
 - 7.5-25 kg: use EpiPen Jr (0.15 mg)
 - ≥ 25 kg: use EpiPen (0.3 mg)
2. Calculate weight-based dose of amoxicillin. Give patient 10% of that dose.
3. Place patient in nearby room and instruct caregiver to notify staff of any changes in status.
4. If no reaction by 20 minutes, give patient remaining 90% of weight-based dose of amoxicillin.
5. Observe another 60 minutes. If no reaction, check VS and physical exam. If all stable, discharge home with regular course of drug.
6. Give patient and family amoxicillin trial education sheet.
7. Update allergy alert in RAVEN. Click the allergy in the banner. Right click over the drug name and choose “cancel.” On the “reason” drop-down menu, choose “OK on Retrial.”

References

1. Kelso JM. "Provocation challenges to evaluate amoxicillin allergy in children." JAMA Pediatrics 2016;170(6):e160282.
2. Mill C, et al. "Assessing the diagnostic properties of a graded oral provocation challenge for the diagnosis of immediate and nonimmediate reactions to amoxicillin in children." JAMA Pediatrics. 2016;170(6):e160033.

This guideline is designed for the general use of most patients but may need to be adapted to meet the special needs of a specific patient as determined by the medical practitioner.
Approved by MSEC 5/8/19.
If comments about this guideline, please contact Jane_McClure@ykhc.org.

CLINICAL GUIDELINES

2019

rev. 06-27-19

Pediatric Neonatal Guidelines

Neonatal Resuscitation Summary	58
Newborn GBS & Infection Evaluation and Treatment.....	59
Jaundice – Neonatal Evaluation & Treatment	60
Neonatal Glucose Screening Evaluation and Treatment.....	61

Gestational Age (weeks)	24	26	28	30	32	34	36	38	40
Estimated Weight (grams)	700	900	1100	1350	1650	2100	2600	3000	3500
Equipment/Supplies : NG/OG Tube = 5F ♦ UVC <32 wks = 3.5F OR >32 wks = 5F ♦ UAC = 3.5F ♦ Chest Needle = 18g									
ETT Size (mm)	2.5	2.5	2.5-3.0	3	3	3-3.5	3.5	3.5-4.0	3.5-4.0
Laryngoscope Blade	00	00	00	0	0	0	0	0-1	0-1
ETT Depth lip to tip (cm) <i>Place at T2 above the carina</i>	6.5-7 cm	6.5-7 cm	7	7-7.5 cm	7.5 cm	8 cm	8.5 cm	9 cm	9.5 cm
UVC insertion (cm). <i>Place just above diaphragm. Must add additional umbilical stump length. May put UVC in 2-4 cm for emergency access.</i>	6.5	6.9	7.2	7.5	8	8.7	9.4	10	10.8
UAC insertion (cm) high line = T6-T9 preferred. <i>Must add additional umbilical stump length</i>	11.1	11.7	12.3	13	14	15.3	16.8	18	19.5
UAC insertion (cm). <i>low line = L3-L4</i> <i>Must add additional umbilical stump length</i>	7.7	7.9	8.1	8.4	8.7	9.1	9.6	10	10.5
Chest Tube	8F	8F	8F	8F	8F	8-10F	8-10F	10-12F	10-12F
Vitals: Heart Rate 120-160 Respiratory Rate 30-60 Mean Blood Pressure = Gestational age in weeks									
Initial Ventilator Settings									
Positive Inspiratory Pressure (PIP) cmH ₂ O	16-22	16-22	16-22	16-22	18-24	18-24	18-24	20-28	20-28
Positive End Expiratory Pressure (PEEP) cmH ₂ O	4-6	4-6	4-6	4-6	4-6	4-6	4-6	4-6	4-6
Inspiratory Time (seconds)	0.3-0.35	0.3-0.35	0.3-0.35	0.3-0.35	0.3-0.35	0.3-0.35	0.35-0.4	0.35-0.4	0.35-0.4
Respiratory Rate (per minute)	30-45	30-45	30-45	30-45	20-40	20-40	20-40	20-40	20-40
Saturation Goal after 10 min.	88-95%	88-95%	88-95%	88-95%	88-95%	88-95%	88-95%	95-98%	95-98%
Medications									
Epinephrine IV/IO 0.1mg/mL 0.1-0.3 ml/kg. May repeat every 3 minutes for asystole.	0.1-0.2ml	0.1-0.3ml	0.1-0.3ml	0.1-0.4ml	0.2-0.5ml	0.2-0.6ml	0.3-0.8ml	0.3-0.9ml	0.4-1ml
Epinephrine ET ONLY 0.1mg/mL 1ml/kg. May repeat every 3 minutes for asystole.	0.7ml	0.9ml	1.1ml	1.3ml	1.6ml	2.1ml	2.6ml	3ml	3.5ml
Curosurf (poractant alfa 80 mg/ml) 2.5 ml/kg divided into two doses. Give curosurf <26 wks OR 26-29 wks and needs ≥ 40% O ₂ > 29 wks with CXR proven RDS	1.8ml	2.3ml	2.8ml	3.4ml	4.1ml	5.3ml	6.5ml	7.5ml	8.8ml
FOR HYPOGLYCEMIA : Give D10 Bolus 2ml/kg IV/IO at 1ml/min. Increase D10 maintenance fluid rate (see below) by 1ml/hr for <2kg or 2ml/hr ≥2kg.	1.4ml	1.8ml	2.2ml	2.7ml	3.3ml	4.2ml	5.2ml	6ml	7ml
Ampicillin (Dilute to 100 mg/ml) 50mg/kg IV/IM	35mg (0.35ml)	45mg (0.45ml)	55mg (0.55ml)	68mg (0.68ml)	83mg (0.83ml)	105mg (1.05ml)	130mg (1.3ml)	150mg (1.5ml)	175mg (1.75ml)
Gentamicin (1mg/1ml) ≤29wks=5mg/kg IV; 30-34wks=4.5mg/kg IV; >35wks=4mg/kg IV. Give IV dose over 30 min. May use IM. DO NOT USE IN VILLAGES! PHARMACIST TO CHECK DOSE.	3.5mg (3.5ml)	4.5mg (4.5ml)	5.5mg (5.5ml)	6mg (6ml)	7.5mg (7.5ml)	9.5mg (9.5ml)	10.5mg (10.5ml)	12mg (12ml)	14mg (14ml)
Volume Expanders: NS or albumin - 10 mL/kg IV or IO. Give over 15-30 minutes or faster if unstable, slower for extreme premies.	7ml	9ml	11ml	13.5ml	16.5ml	21ml	26ml	30ml	35ml
D10 Maint Fluids <750gm=90-100ml/kg/24hr >750gm=80ml/kg/24hr. (goal blood glucose is 50-110mg/dl)	3ml/hr	3ml/hr	3.7ml/hr	4.5ml/hr	5.5ml/hr	7ml/hr	8.7ml/hr	10ml/hr	12ml/hr
Phenobarb (130mg/ml) 10mg/kg IV, IO, IM, PR May give additional 10mg/kg dose.	7mg (0.05ml)	9mg (0.07ml)	11mg (0.08ml)	13.5mg (0.1ml)	16.5mg (0.13ml)	21mg (0.16ml)	26mg (0.2ml)	30mg (0.23ml)	35mg (0.27ml)

Reviewed and updated by YKHC Pediatrics, OB Nursing, and Pharmacy Services in conjunction with Providence NICU staff.

Approved by MSEC Pending

Newborn GBS & Infection Evaluation and Treatment

MSEC approved 09/21/17

- Signs of Neonatal Sepsis**
- Temp \geq 100.4
 - Irritability
 - Poor Feeding
 - Hypoglycemia
 - Hypothermia
 - Tachypnea
 - Tachycardia
 - "not acting right"

- Intrapartum Maternal GBS Risk Factors**
- Chorioamnionitis
 - Previous infant with invasive GBS disease
 - GBS during current pregnancy
 - GBS status unknown
 - Labor at $<$ 37 weeks gestation
 - Rupture of membranes \geq 18 hours
 - Intrapartum temperature $>$ 100.4
 - GBS bacteriuria

Note: If mother receives "inadequate prophylaxis" (eg. clindamycin, vancomycin, or erythromycin) for GBS status, provider may consider a limited work up of the neonate

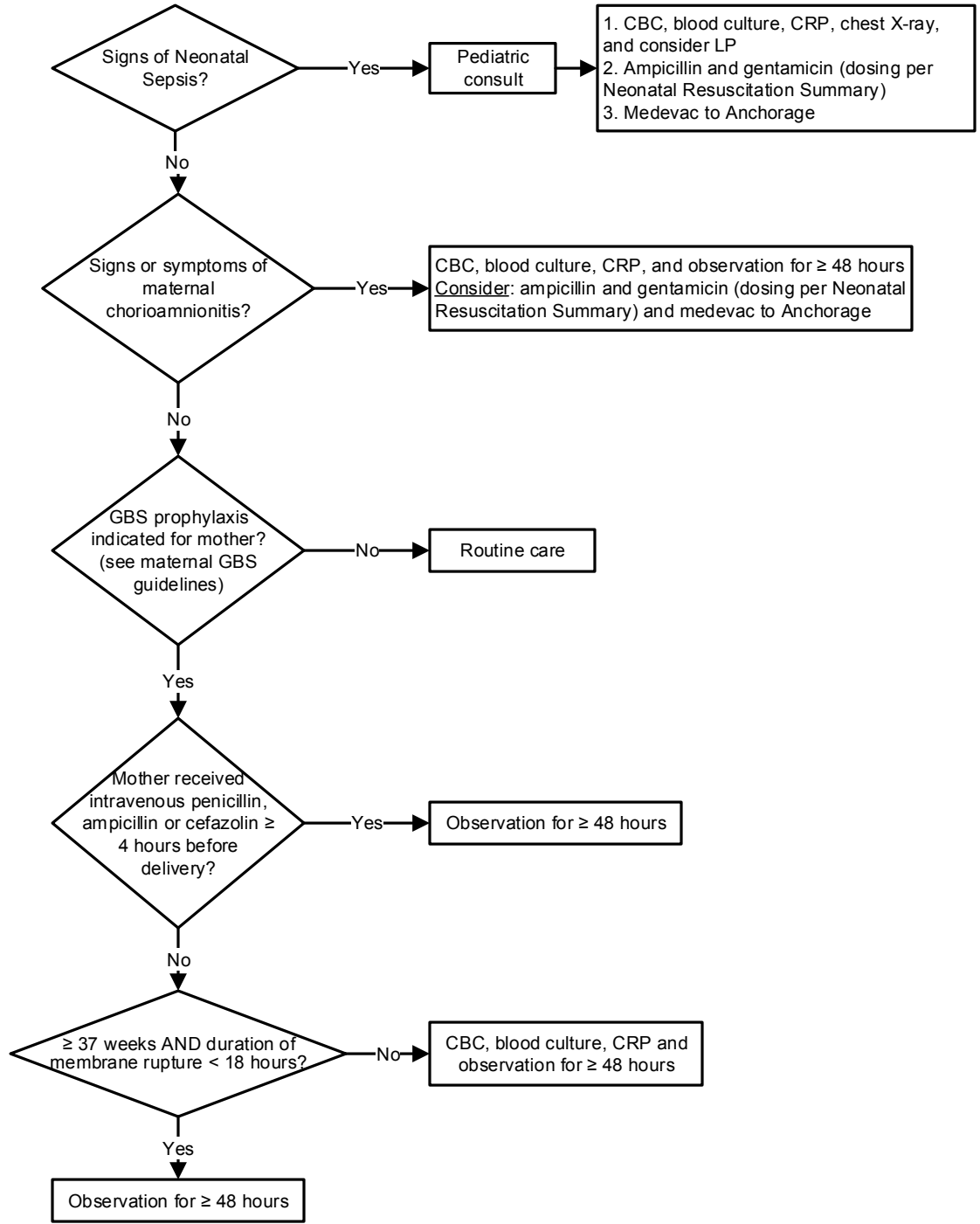

This guideline is designed for the general use of most patients, but may need to be adapted to meet the special needs of a specific patient as determined by the patient's medical practitioner.

Jaundice – Neonatal Evaluation & Treatment

MSEC approved 6/5/19

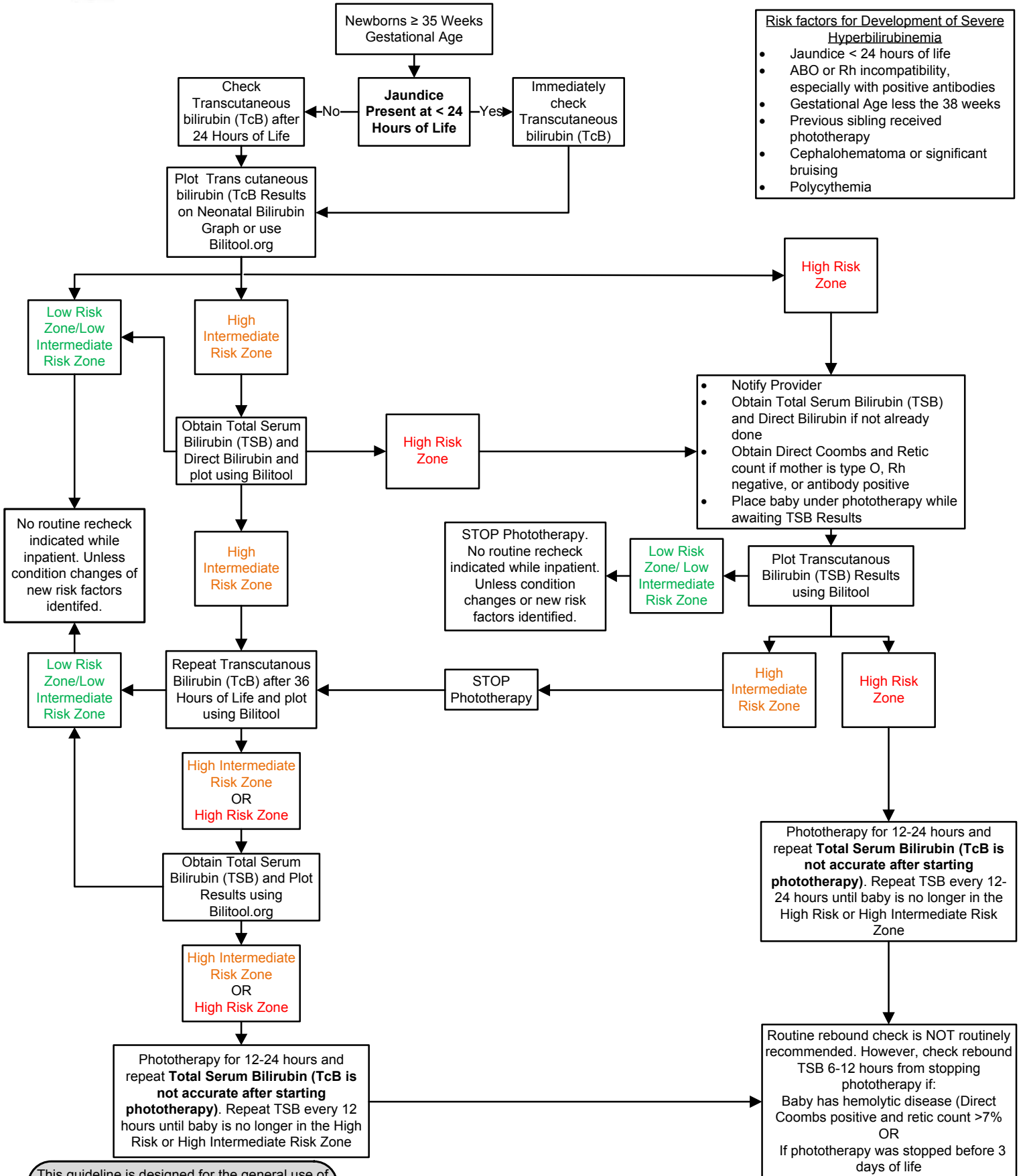

This guideline is designed for the general use of most patients but may need to be adapted to meet the special needs of a specific patient as determined by the medical practitioner.

Neonatal Glucose Screening Evaluation and Treatment

MSEC Approved 3/21/19

ANY TIME INFANT IS SYMPTOMATIC OR BG IS <25 AFTER 1ST DEXTROSE GEL DOSE, GIVE DEXTROSE GEL AND NOTIFY PROVIDER IMMEDIATELY
THIS SCREENING PROTOCOL NO LONGER APPLIES

0-4 HOURS OF AGE

At Risk Infants (See Box)
Begin feeding within one hour of birth. First glucose should be obtained 30 minutes after completion of first feed

Risk Factors and Indications for Screening of Asymptotic Newborns:
SGA (<10thile BW)
LGA (>90thile BW)
Infant of Diabetic Mother
Late Preterm (34 0/7 – 36 6/7)
Other clinical situation per physician discretion

DEXTROSE (40%) GEL DOSING	
Birth Weight	mLS to Administer
≤ 2 kg	1 ml
>2 - 2.5 kg	1.25 ml
>2.5 - 3 kg	1.5 ml
>3 kg - 3.5 kg	1.75 ml
>3.5 - 4 kg	2 ml
>4 kg - 4.5 kg	2.25 ml
>4.5 - 5 kg	2.5 ml

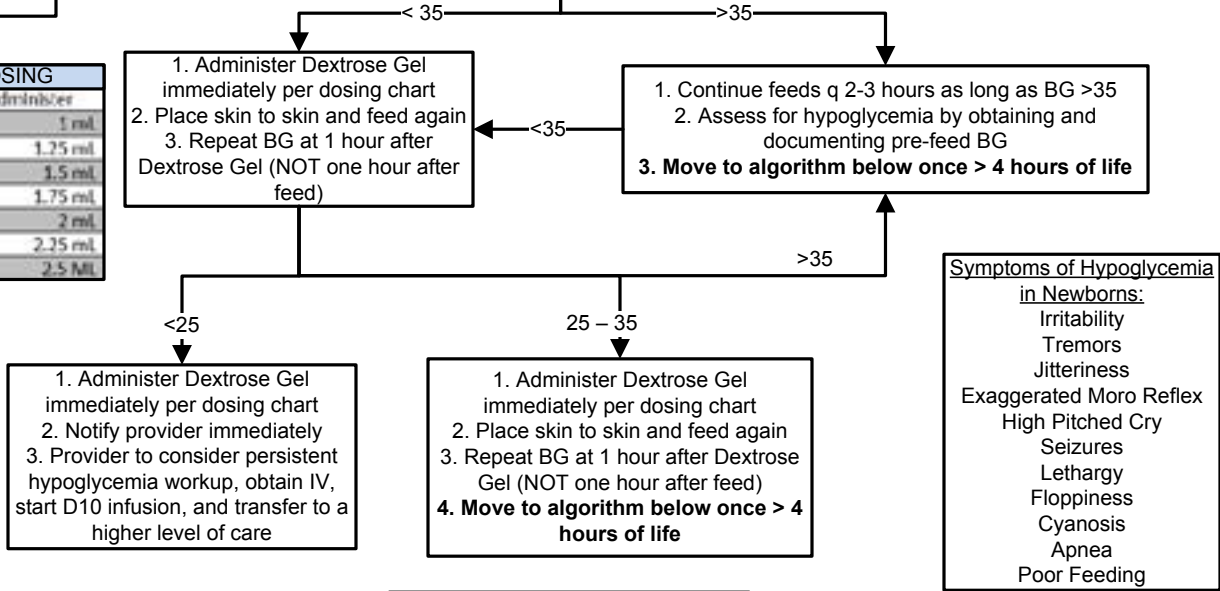

> 4 - 48 HOURS OF AGE

1. Continue feeds q 2-3 hours
2. Assess for hypoglycemia by obtaining and documenting pre-feed BG

Target Glucose Levels for Age

Birth to 4 hours of life	>35 mg/dl
>4 - 24 hours of life	>45 mg/dl
>24 - 48 hours of life	>50 mg/dl

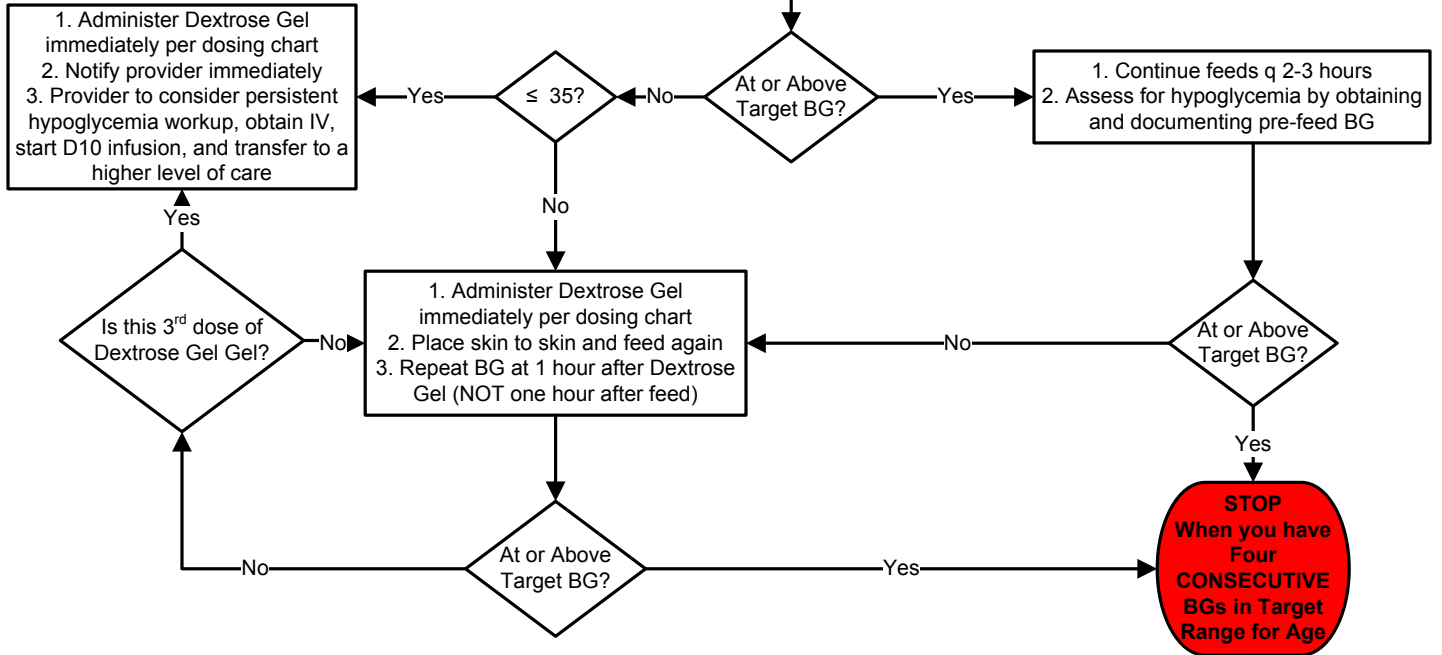

This guideline is designed for the general use of most patients but may need to be adapted to meet the special needs of a specific patient as determined by the medical practitioner.

CLINICAL GUIDELINES

2019

rev. 06-27-19

Pediatric Protocols/Reference

Pediatric Induced Sputum Collection.....	63
Pediatric Hip Exam and Surveillance Protocol	64
Acute Concussion Evaluation (Ace) ED Version	65
Acute Concussion Evaluation (ACE) OP Version	67
ASAA Healthcare Provider Release and Return to Play Protocol ...	69
Use of Consultants at YKHC	71

Pediatric Induced Sputum Collection

MSEC approved 4/26/18

POLICY: To obtain sputum samples safely and effectively in pediatric patients

PROCEDURE: Induced Sputum Collection in Pediatric Patients

1. Premedicate with albuterol 2.5 mg/3mL (0.083%) solution – 3 mL via nebulizer to induce bronchodilation and better facilitate delivery of hypertonic saline. This can help prevent the development of bronchospasm during delivery of hypertonic saline. An MDI with a mask and spacer is also an acceptable substitution.
2. Give 5 mL of 3% hypertonic saline solution via nebulizer over period of at least 10 minutes as prolonged administration has been shown to yield better samples.
3. If patient has copious nasal secretions, consider nasal suction with olive tip.
4. Obtain mucus specimen trap with suction catheter appropriate for patient size. Measure from tip of nose to the tragus for depth of catheter insertion and obtain sample via suction of the nasopharynx. The goal is to induce a gag and then a cough. Sample is expected to be blood-tinged.
5. Place specimen in appropriate collection container for desired test.
 - a. For r/o pulmonary tuberculosis, collect 3 induced sputum samples at least 8 hours apart – one must be first morning sample. Send for Acid Fast Bacilli Smear and Culture. Sample must be a minimum of 5 ml, may add sterile water to achieve desired volume.
 - b. Standard sputum cultures do not have a minimum volume and can be placed in a sterile specimen cup.

***Contraindications to above procedure:** oxygen saturation of <92% despite supplemental oxygen therapy, inability to protect the airways, severe bronchospasm, or designation as inappropriate by the clinician for another reason (eg, midface trauma). After exclusion or resolution of these conditions, sputum induction can be considered.

Pediatric Hip Exam and Surveillance Protocol

MSEC approved 4/26/18

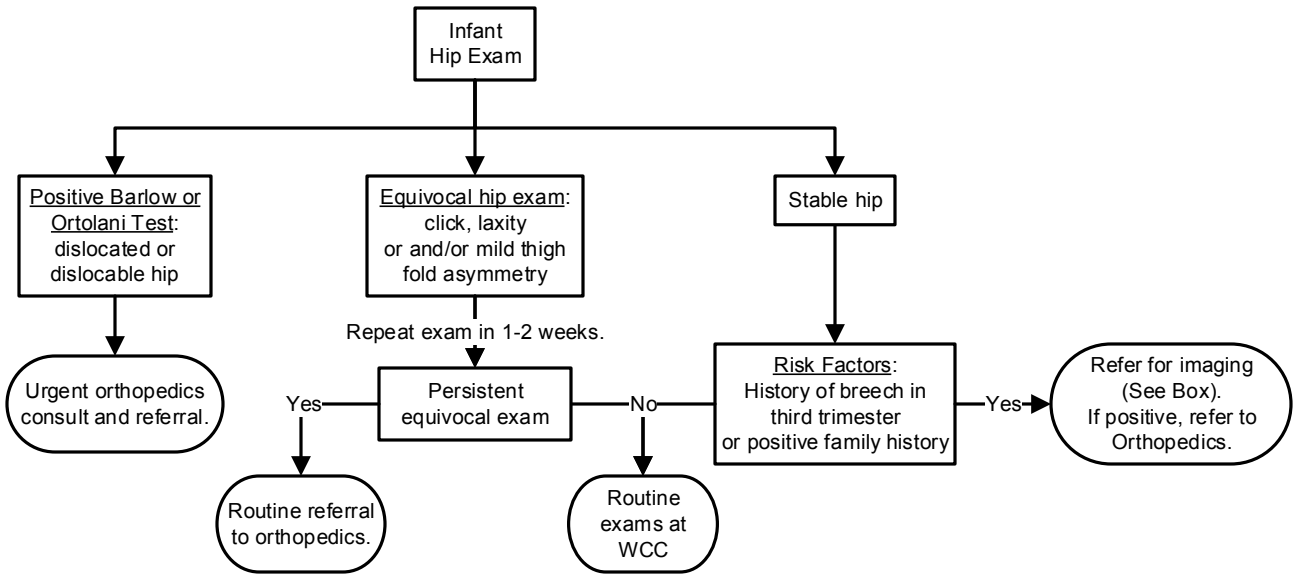

Barlow Test

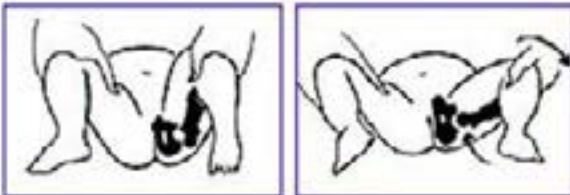

Ortolani Test

The Barlow test is an attempt to dislocate the hip. If positive, you will feel the hip sublux or dislocate. The Ortolani test is the maneuver to reduce a dislocated hip. If positive, you will feel a clunk.

Imaging

- Hip ultrasound: at 6 weeks to 4 months of age.
 - Performed at Alaska Regional Hospital
 - Place order for "Refer to Pediatric Clinic External (MRI / EEG / VFSS / Hip US)" with brief history.
 - Send a RAVEN Communication to Chronic Peds Case Manager Pool about the referral and level of importance.
- X-ray, AP & Frogleg: over 4 months of age.
 - Performed at YKHC
 - Place a future order for "Bilateral Hip Complete X-ray" and put in comments "AP and frog leg views to rule-out hip dysplasia."
 - Send a RAVEN Communication to Chronic Peds Case Manager Pool stating the order was placed and requesting an appointment for this with a pediatric provider in Bethel.

Orthopedics Consults & Referrals

- Consultation:
 - Native patients: contact ANMC orthopedic surgeon on call at (907) 563-2662 (*97).
 - Non-native patients: contact Ken Thomas at Anchorage Fracture & Orthopedics at (907) 563-3145.
- Referral:
 - Place an order for "Refer to Orthopedics External" with brief history. Note the orthopedist who was consulted. Indicate where the referral should be sent
 - Send a RAVEN Communication to Chronic Peds Case Manager Pool about the referral and level of importance.

This guideline is designed for the general use of most patients but may need to be adapted to meet the special needs of a specific patient as determined by the medical practitioner.

Acute Concussion Evaluation (Ace) ED Version

A. Injury Characteristics Date/Time of Injury _____ Reporter: Patient Parent Spouse Other _____

1. Injury Description _____

1a. Is there evidence of a forcible blow to the head (direct or indirect)? Yes No Unknown
 1b. Is there evidence of intracranial injury or skull fracture? Yes No Unknown
 1c. Location of Impact: Frontal Lft Temporal Rt Temporal Lft Parietal Rt Parietal Occipital Neck Indirect Force

2. Cause: MVC Pedestrian-MVC Fall Assault Sports (specify) _____ Other _____

3. Amnesia Before (Retrograde) Are there any events just BEFORE the injury that you/ person has no memory of (even brief)? Yes No Duration _____

4. Amnesia After (Anterograde) Are there any events just AFTER the injury that you/ person has no memory of (even brief)? Yes No Duration _____

5. Loss of Consciousness: Did you/ person lose consciousness? Yes No Duration _____

6. EARLY SIGNS: Appears dazed or stunned Is confused about events Answers questions slowly Repeats Questions Forgetful (recent info)

7. Seizures: Were seizures observed? No Yes Detail _____

B. Symptom Check List* Since the injury, has the person experienced any of these symptoms any more than usual today or in the past day?
 Indicate presence of each symptom (0=No, 1=Yes). *Lovell & Collins, 1998 JHTR

PHYSICAL (10)		COGNITIVE (4)		SLEEP (4)		
Headache	0 1	Feeling mentally foggy	0 1	Drowsiness	0 1	
Nausea	0 1	Feeling slowed down	0 1	Sleeping less than usual	0 1	N/A
Vomiting	0 1	Difficulty concentrating	0 1	Sleeping more than usual	0 1	N/A
Balance problems	0 1	Difficulty remembering	0 1	Trouble falling asleep	0 1	N/A
Dizziness	0 1	COGNITIVE Total (0-4) _____		SLEEP Total (0-4) _____		
Visual problems	0 1	EMOTIONAL (4)				
Fatigue	0 1	Irritability	0 1			
Sensitivity to light	0 1	Sadness	0 1			
Sensitivity to noise	0 1	More emotional	0 1			
Numbness/Tingling	0 1	Nervousness	0 1			
PHYSICAL Total (0-10) _____		EMOTIONAL Total (0-4) _____				
(Add Physical, Cognitive, Emotion, Sleep totals)						
Total Symptom Score (0-22)						

Other Observations

Patient Participation: Full Partial None
Reason for Partial/None: Young Age Confused Inattentive Low arousal Emotional Upset In Pain Other _____

C. Concussion History: Previous# 0 1 2 3 4 5 Date(s) _____

Headache History: Prior treatment for headache N Y Details _____

D. Diagnosis (ICD): Concussion w/o LOC 850.0 Concussion w/ LOC 850.1 Concussion (Unspecified) 850.9 Other (854) _____
 No diagnosis

E. Follow-Up Action Plan Referral to PCP for Office Monitoring MD Name _____

 Neuropsychological Testing (recommended for Return to Sport decisions and academic/ behavioral management)

 Physician: Neurosurgery Neurology Sports Medicine Physiatry Psychiatry

 Other _____

ACE-ED Completed by: _____ MD RN NP DO

A concussion is an injury to the brain as a result of a force or jolt applied directly or indirectly to the head, which produces a range of possible symptoms, and may or may not involve a loss of consciousness. It is a complex pathophysiologic process affecting the brain, induced by traumatic biomechanical forces secondary to direct or indirect forces to the head. Disturbance of brain function is related to neurometabolic dysfunction, rather than structural injury, and is typically associated with normal structural neuroimaging findings (i.e., CT scan, MRI). Concussion may or may not involve a loss of consciousness (LOC). Concussion results in a constellation of cognitive, somatic, emotional and sleep-related symptoms. Duration of symptoms are variable and may last for as short as several minutes and last as long as several days, weeks, months or even longer in some cases.

ACE ED Instructions

A. Injury Characteristics

1. **Injury Description:** Ask for **description of events** resulting in the injury; how the injury occurred, type of force, location on head.
2. **Cause:** Indicate the cause of injury or write in Other cause.
- 3/4. **Amnesia:** Determine whether child was not registering memories (amnesia) – **before** (retrograde) and **after** (anterograde) injury. Estimate length of time for each (Retrograde amnesia “What is the **last thing** you remember before your injury?” Anterograde amnesia “What is the first thing you remember after your injury?”)
5. **Loss of consciousness (LOC)** - If occurs, determine length of LOC.
6. **Early signs observed by others.** Ask the individuals who know the patient (parent, spouse, friend, etc.) about signs of the concussion/ mTBI that they may have observed. Signs are typically observed early after the injury.
7. **Seizures:** Inquire whether **seizures** were observed or not.

B. Symptom Check List:

- Ask patient (and/ or parent, if child) to report presence of the **4 categories** of symptoms since injury. It is important to assess all listed symptoms as different parts of the brain control different functions. One or all symptoms may be present depending upon mechanisms of injury. If the symptom is not present, circle “0” on the scale. Circle “1” if present.
- Note: Most sleep symptoms are only applicable after a night has passed since the injury. If not applicable, circle N/A. Drowsiness may be present on the day of injury.
- Since symptoms can be present pre-morbidly/ at baseline (e.g., inattention, headaches, sleep, sadness), it is important to **assess change** from its typical presentation. For **any symptom** - if Patient/ Parent indicates “I/ He usually has that problem/symptom” – Ask “Are you/ they experiencing this symptom **more than usual** or in a **different manner than usual?**” If “Yes” circle “1”.

Scoring: Sum total **number** of symptoms present per area, and sum all 4 areas into Total Symptom Score. (Note: Most sleep symptoms are only applicable after a night has passed since the injury. Drowsiness may be present on the day of injury.) If symptoms are new and present, there is no lower limit symptom score. Any score > 0 indicates **positive symptom** history.

- **General Impression:** Ask how different the person is acting than usual. Circle 0 (No difference) to 6 (Major) to rate degree.
- **Patient Participation:** Indicate the extent to which the patient is able to participate in the evaluation and, if less than fully, give reason for Partial or No participation.

C. Concussion history: Assess the number and date(s) of prior concussions.⁴⁻⁸ History of prior concussions, especially recent (within past several weeks or months) would suggest the need for more conservative decision-making regarding Return to Play, and general post-injury management.

Headache history: Assess personal history of diagnosis/treatment for headaches. Recent research indicates headache (migraine in particular) can result in protracted recovery from concussion.⁸⁻¹¹

D. Diagnosis: Assign the most appropriate diagnosis given the following:

850.0 (Concussion, with no loss of consciousness) – Positive Injury Description (A1), i.e., forcible direct/ indirect blow to the head; plus evidence of active symptoms (B) of any type and number related to the trauma; no evidence of LOC (A5), skull fracture, or other intracranial injury.

850.1 (Concussion, with brief loss of consciousness < 1 hour) - Positive Injury Description (A1), i.e., forcible direct/ indirect blow to the head; plus evidence of active symptoms (B) of any type and number related to the trauma; positive evidence of LOC (A5); no skull fracture, or other intracranial injury.

850.9 (Concussion, unspecified) - Positive Injury Description (A1), i.e., forcible direct/ indirect blow to the head; plus evidence of active symptoms (B) of any type and number related to the trauma; unclear/unknown injury details; unclear evidence of LOC (A5), no skull fracture, or other intracranial injury.

NOTE: If there is evidence of skull fracture of structural intracranial injury to the brain, consider 854 (Intracranial injury of other and unspecified nature; 854.0 Without mention of open intracranial wound, 854.1 With open intracranial wound). Avoid using nonspecific Head injury NOS (959.01) whenever possible.

E. Follow-Up Action: Determine a plan of action for follow-up of symptomatic patients. Serial evaluation of the concussion is critical as symptoms may resolve, worsen, or ebb and flow depending upon a variety of factors (e.g., cognitive/ physical exertion, comorbidities). Referral to a specialist can be particularly valuable to help manage certain aspects of the patient’s condition.

(a) Patient monitoring in the primary care physician office.

(b) Referral to a specialist: particularly valuable to help manage certain aspects of the patient’s condition.

- **Neuropsychological Testing** is particularly relevant for cognitive and/or behavioral dysfunction affecting school, home or work activities, for purpose of treatment planning. Testing is also recommended when a patient may be returning to sports or other at-risk activities.
- **Physician Evaluation** is particularly relevant for medical evaluation and management of concussion. Also, critical for evaluation and management of focal neurologic, sensory, vestibular, and motor concerns. May be useful for medication management (e.g., headaches, sleep disturbance, depression) if post-concussive problems persist.

Acute Concussion Evaluation (ACE) OP Version

A. Injury Characteristics Date/Time of Injury _____ Reporter: Patient Parent Spouse Other _____

- 1. Injury Description** _____
- 1a. Is there evidence of a forcible blow to the head (direct or indirect)? Yes No Unknown
 1b. Is there evidence of intracranial injury or skull fracture? Yes No Unknown
 1c. Location of Impact: Frontal Lft Temporal Rt Temporal Lft Parietal Rt Parietal Occipital Neck Indirect Force
2. Cause: MVC Pedestrian-MVC Fall Assault Sports (*specify*) _____ Other _____
3. Amnesia Before (Retrograde) Are there any events just BEFORE the injury that you/ person has no memory of (even brief)? Yes No Duration _____
4. Amnesia After (Anterograde) Are there any events just AFTER the injury that you/ person has no memory of (even brief)? Yes No Duration _____
5. Loss of Consciousness: Did you/ person lose consciousness? Yes No Duration _____
6. EARLY SIGNS: Appears dazed or stunned Is confused about events Answers questions slowly Repeats Questions Forgetful (recent info)
7. Seizures: Were seizures observed? No Yes Detail _____

B. Symptom Check List* Since the injury, has the person experienced any of these symptoms any more than usual today or in the past day?
 Indicate presence of each symptom (0=No, 1=Yes). *Lovell & Collins, 1998 JHTR

PHYSICAL (10)			COGNITIVE (4)			SLEEP (4)			
Headache	0	1	Feeling mentally foggy	0	1	Drowsiness	0	1	
Nausea	0	1	Feeling slowed down	0	1	Sleeping less than usual	0	1 N/A	
Vomiting	0	1	Difficulty concentrating	0	1	Sleeping more than usual	0	1 N/A	
Balance problems	0	1	Difficulty remembering	0	1	Trouble falling asleep	0	1 N/A	
Dizziness	0	1	COGNITIVE Total (0-4) _____		SLEEP Total (0-4) _____				
Visual problems	0	1	EMOTIONAL (4)		Exertion: Do these symptoms <u>worsen</u> with: Physical Activity <input type="checkbox"/> Yes <input type="checkbox"/> No <input type="checkbox"/> N/A Cognitive Activity <input type="checkbox"/> Yes <input type="checkbox"/> No <input type="checkbox"/> N/A Overall Rating: How <u>different</u> is the person acting compared to his/her usual self? (circle) Normal 0 1 2 3 4 5 6 Very Different				
Fatigue	0	1	Irritability	0					1
Sensitivity to light	0	1	Sadness	0					1
Sensitivity to noise	0	1	More emotional	0					1
Numbness/Tingling	0	1	Nervousness	0					1
PHYSICAL Total (0-10) _____			EMOTIONAL Total (0-4) _____						
(Add Physical, Cognitive, Emotion, Sleep totals)									
Total Symptom Score (0-22)									

C. Risk Factors for Protracted Recovery (*check all that apply*)

Concussion History? Y ___ N ___		Headache History? Y ___ N ___		Developmental History		Psychiatric History
Previous # 1 2 3 4 5 6+	✓	Prior treatment for headache	✓	Learning disabilities	✓	Anxiety
Longest symptom duration Days ___ Weeks ___ Months ___ Years ___		History of migraine headache ___ Personal ___ Family _____		Attention-Deficit/ Hyperactivity Disorder		Depression
If multiple concussions, less force caused reinjury? Yes ___ No ___				Other developmental disorder _____		Other psychiatric disorder _____

List other comorbid medical disorders or medication usage (e.g., hypothyroid, seizures) _____

D. RED FLAGS for acute emergency management: Refer to the emergency department with sudden onset of any of the following:

- * Headaches that worsen
- * Looks very drowsy/ can't be awakened
- * Can't recognize people or places
- * Neck pain
- * Seizures
- * Repeated vomiting
- * Increasing confusion or irritability
- * Unusual behavioral change
- * Focal neurologic signs
- * Slurred speech
- * Weakness or numbness in arms/legs
- * Change in state of consciousness

E. Diagnosis (ICD): Concussion w/o LOC 850.0 Concussion w/ LOC 850.1 Concussion (Unspecified) 850.9 Other (854) _____
 No diagnosis

F. Follow-Up Action Plan Complete **ACE Care Plan** and provide copy to patient/family.

- No Follow-Up Needed
 Physician/Clinician Office Monitoring: Date of next follow-up _____
 Referral:
 Neuropsychological Testing
 Physician: Neurosurgery ___ Neurology ___ Sports Medicine ___ Psychiatrist ___ Psychologist ___ Other _____
 Emergency Department

ACE Completed by: _____ MD RN NP PhD ATC

A concussion (or mild traumatic brain injury (MTBI)) is a complex pathophysiologic process affecting the brain, induced by traumatic biomechanical forces secondary to direct or indirect forces to the head. Disturbance of brain function is related to neurometabolic dysfunction, rather than structural injury, and is typically associated with normal structural neuroimaging findings (i.e., CT scan, MRI). Concussion may or may not involve a loss of consciousness (LOC). Concussion results in a constellation of physical, cognitive, emotional, and sleep-related symptoms. Symptoms may last from several minutes to days, weeks, months or even longer in some cases.

ACE Instructions

The ACE is intended to provide an evidence-based clinical protocol to conduct an initial evaluation and diagnosis of patients (both children and adults) with known or suspected MTBI. The research evidence documenting the importance of these components in the evaluation of an MTBI is provided in the reference list.

A. Injury Characteristics:

1. Obtain **description of the injury** – how injury occurred, type of force, location on the head or body (if force transmitted to head). Different biomechanics of injury may result in differential symptom patterns (e.g., occipital blow may result in visual changes, balance difficulties).
2. Indicate the **cause of injury**. Greater forces associated with the trauma are likely to result in more severe presentation of symptoms.
- 3/4. **Amnesia:** Amnesia is defined as the failure to form new memories. Determine whether amnesia has occurred and attempt to determine length of time of memory dysfunction – **before** (retrograde) and **after** (anterograde) injury. Even seconds to minutes of memory loss can be predictive of outcome. Recent research has indicated that amnesia may be up to 4-10 times more predictive of symptoms and cognitive deficits following concussion than is LOC (less than 1 minute).¹
5. **Loss of consciousness (LOC)** – If occurs, determine length of LOC.
6. **Early signs.** If present, ask the individuals who know the patient (parent, spouse, friend, etc) about specific signs of the concussion that may have been observed. These signs are typically observed early after the injury.
7. Inquire whether **seizures** were observed or not.

B. Symptom Checklist:²

1. Ask patient (and/or parent, if child) to report presence of the four categories of symptoms since injury. It is important to assess all listed symptoms as different parts of the brain control different functions. One or all symptoms may be present depending upon mechanisms of injury.³ Record “1” for Yes or “0” for No for their presence or absence, respectively.
2. For all symptoms, indicate presence of symptoms as experienced within the past 24 hours. Since symptoms can be present pre-morbidly/at baseline (e.g., inattention, headaches, sleep, sadness), it is important to assess **change** from their usual presentation.
3. **Scoring:** Sum total **number** of symptoms present per area, and sum all four areas into Total Symptom Score (score range 0-22). (Note: most sleep symptoms are only applicable after a night has passed since the injury. Drowsiness may be present on the day of injury.) If symptoms are new and present, there is no lower limit symptom score. Any **score > 0** indicates **positive symptom** history.
4. **Exertion:** Inquire whether any symptoms worsen with physical (e.g., running, climbing stairs, bike riding) and/or cognitive (e.g., academic studies, multi-tasking at work, reading or other tasks requiring focused concentration) exertion. Clinicians should be aware that symptoms will typically worsen or re-emerge with exertion, indicating incomplete recovery. Over-exertion may protract recovery.
5. **Overall Rating:** Determine how different the person is acting from their usual self. Circle “0” (Normal) to “6” (Very Different).

C. Risk Factors for Protracted Recovery:

 Assess the following risk factors as possible complicating factors in the recovery process.

1. **Concussion history:** Assess the number and date(s) of prior concussions, the duration of symptoms for each injury, and whether less biomechanical force resulted in re-injury. Research indicates that cognitive and symptom effects of concussion may be cumulative, especially if there is minimal duration of time between injuries and less biomechanical force results in subsequent concussion (which may indicate incomplete recovery from initial trauma).⁴⁻⁸
2. **Headache history:** Assess personal and/or family history of diagnosis/treatment for headaches. Research indicates headache (migraine in particular) can result in protracted recovery from concussion.⁸⁻¹¹
3. **Developmental history:** Assess history of learning disabilities, Attention-Deficit/Hyperactivity Disorder or other developmental disorders. Research indicates that there is the possibility of a longer period of recovery with these conditions.¹²
4. **Psychiatric history:** Assess for history of depression/mood disorder, anxiety, and/or sleep disorder.¹³⁻¹⁶

D. Red Flags:

 The patient should be carefully observed over the first 24-48 hours for these serious signs. Red flags are to be assessed as **possible signs of deteriorating neurological functioning**. Any positive report should prompt strong consideration of referral for emergency medical evaluation (e.g. CT Scan to rule out intracranial bleed or other structural pathology).¹⁷

E. Diagnosis:

 The following ICD diagnostic codes may be applicable.

850.0 (Concussion, with no loss of consciousness) – Positive injury description with evidence of forcible direct/ indirect blow to the head (A1a); plus evidence of active symptoms (B) of any type and number related to the trauma (Total Symptom Score >0); no evidence of LOC (A5), skull fracture or intracranial injury (A1b).

850.1 (Concussion, with brief loss of consciousness < 1 hour) – Positive injury description with evidence of forcible direct/ indirect blow to the head (A1a); plus evidence of active symptoms (B) of any type and number related to the trauma (Total Symptom Score >0); positive evidence of LOC (A5), skull fracture or intracranial injury (A1b).

850.9 (Concussion, unspecified) – Positive injury description with evidence of forcible direct/ indirect blow to the head (A1a); plus evidence of active symptoms (B) of any type and number related to the trauma (Total Symptom Score >0); unclear/unknown injury details; unclear evidence of LOC (A5), no skull fracture or intracranial injury.

Other Diagnoses – If the patient presents with a positive injury description and associated symptoms, but additional evidence of intracranial injury (A 1b) such as from neuroimaging, a moderate TBI and the diagnostic category of 854 (Intracranial injury) should be considered.

F. Follow-Up Action Plan:

 Develop a follow-up plan of action for symptomatic patients. The physician/clinician may decide to (1) monitor the patient in the office or (2) refer them to a specialist. Serial evaluation of the concussion is critical as symptoms may resolve, worsen, or ebb and flow depending upon many factors (e.g., cognitive/physical exertion, comorbidities). Referral to a specialist can be particularly valuable to help manage certain aspects of the patient's condition. (Physician/Clinician should also complete the ACE Care Plan included in this tool kit.)

1. **Physician/Clinician serial monitoring** – Particularly appropriate if number and severity of symptoms are steadily decreasing over time and/or fully resolve within 3-5 days. If steady reduction is not evident, referral to a specialist is warranted.
2. **Referral to a specialist** – Appropriate if symptom reduction is not evident in 3-5 days, or sooner if symptom profile is concerning in type/severity.
 - **Neuropsychological Testing** can provide valuable information to help assess a patient's brain function and impairment and assist with treatment planning, such as return to play decisions.
 - **Physician Evaluation** is particularly relevant for medical evaluation and management of concussion. It is also critical for evaluating and managing focal neurologic, sensory, vestibular, and motor concerns. It may be useful for medication management (e.g., headaches, sleep disturbance, depression) if post-concussive problems persist.

ASAA HEALTHCARE PROVIDER RELEASE AND RETURN TO PLAY PROTOCOL (RTP)

Student Name: _____

Sport: _____ School: _____ Birthdate: _____

Date of Injury: _____ Description: _____

IMPORTANT NOTE TO HEALTHCARE PROVIDER

Per AS 14.30.142, as amended, a student who has been removed from participation in a practice or game for suspicion of concussion may not return to play until the student has been evaluated and cleared for participation by an Athletic Trainer OR by a qualified person who verifies that he or she is currently trained in the evaluation and management of concussions.

"Qualified person" means either:

- 1) A health care provider licensed in Alaska, or exempt from licensure under Alaska law(AS 08.64.370(1), (2), or (4),
OR
- 2) a person acting at the direction and under the supervision of a physician licensed in Alaska, or exempt from licensure.

As interpreted by ASAA, Athletic Trainer means a Certified Athletic Trainer.

As interpreted by ASAA, "Trained" means that the provider:

- 1) Has completed the online CDC Concussion Course for Clinicians (www.preventingconcussions.org) in the last two years,
AND
- 2) Has **a)** completed 2 hours of CME in Sports Concussion Management in the last 2 years, or **b)** has completed a one-year Sports Medicine Fellowship, a Certificate of Added Qualifications in Sports Medicine, or a Residency in Neurology or Neurosurgery.

IF YOU DO NOT MEET THESE CRITERIA, PLEASE REFER THE STUDENT ATHLETE TO A HEALTHCARE PROVIDER WHO DOES

If an athlete is removed from participation in an activity because of a suspected concussion:

BUT is found **not to have a concussion**, the athlete's return to play should be determined by the athlete's medical provider in accordance with the provider's assessment of the athlete's condition and readiness to participate;

AND is **determined to have sustained a concussion**, the athlete's readiness to return to participation should be assessed in accordance with the Alaska School Activities Association's graduated Return to Play (RTP) protocol. All student athletes with a concussion must successfully complete an appropriate RTP Protocol that lasts a minimum of six days before resuming full athletic activity. The Return to Play protocol recommended by ASAA's Sports Medicine Advisory Committee is described below.

Students should begin with a period of complete rest in which they avoid cognitive and physical exertion. As symptoms diminish, and the athlete feels able, he/she can begin trials of cognitive work, e.g. reading, texting, computer, TV, school. The introduction of cognitive work should be in short increments which increase progressively in length and intensity so long as concussion symptoms do not recur or worsen. When several hours of cognitive work are well tolerated at home, then attendance at a half day of school is appropriate. When a full day of school is tolerated, then homework may be added. Academic accommodations may be necessary for student athletes as they return to school following a concussion. If cognitive work at any time provokes or exacerbates symptoms, then the work should be discontinued, additional cognitive work should be minimized until symptoms regress, and the student can attempt to advance cognitive work again on the following day.

Only when the concussion symptoms have been entirely absent for 24 hours, does Day 1 of the progressive return to physical activity begin. The **Return To Play Protocol** is to take place over a **minimum of six days, with at least 24 hours between each step**. The rate of progression through the steps in the program should be individualized. Factors which may slow the rate are young age, history of previous concussions, number/severity/duration of concussion symptoms, medical risk factors, and the concussion risk of the sports to which the athlete will return. Physical or cognitive activity that provokes recurrence of concussive symptoms will delay recovery and increase the risk of future concussion. Therefore, if symptoms recur at any step, then physical activity should stop until 24 hours after resolution of the symptoms, and then resume at the previous step.

Student Name: _____

SYMPTOMATIC STAGE: Physical and Cognitive Rest; Then Incremental Cognitive Work, without Provoking Symptoms.	
Day 1	Begin when symptom free for 24 hours. 15 min of light aerobic activity: walk, swim, stationary bike. NO resistance training.
Day 2	30 min light-moderate aerobic activity: jog, more intense walk, swim, stationary bike. NO resistance training. START PE class at previous day's activity level. As RTP Protocol activity level increases, PE activity level remains 1 day behind
Day 3	30 min mod-heavy aerobic activity: run, swim, cycle, skate, Nordic ski. NO resistance training.
Day 4	30 min heavy aerobic activity: hard run, swim, cycle, skate, Nordic ski. 15 min Resistance Training: push-up, sit-up, weightlifting
Day 5	Return to Practice, Non-contact Limited Participation: Routine sport-specific drills
Day 6	Return to Full-Contact Practice
Day 7	Medically Eligible for Competition after completing RTP Protocol and is cleared by Healthcare Professional. ASAA Eligibility Criteria must be met before return to competition.

SECTION 1: THE CONCUSSED ATHLETE - to be completed by Healthcare Provider

Student has sustained a concussion and is not yet ready to begin the Return to Play Protocol.

Student is cleared to begin ASAA's **Return to Play Protocol** with any modifications noted below. *This clearance is no longer effective if student's symptoms return and persist.*

Student is entirely free of concussion symptoms and has completed the ASAA Return to Play Protocol as described above. The athlete is medically eligible to return to competition.

Please note any additional modifications to ASAA's Return to Play Protocol below [attach more pages if needed]:

SECTION 2: THE NON-CONCUSSED ATHLETE - to be completed by Healthcare Provider

Student has **NOT** sustained a concussion. The **Medical Diagnosis** which explains his/her symptoms is: This is **REQUIRED** if checking the first box: _____

Student is cleared to return to full sports participation. Medical Dx: _____

Student is cleared for limited participation with the following restrictions [attach more pages if needed]:

SECTION 3: HEALTHCARE PROFESSIONAL ATTESTATION

By signing this form, I attest that I am a **Qualified Healthcare provider authorized under AS 14.30.142** and that I meet the ASAA definition of "Currently Trained" in the evaluation and management of concussion, as explained above. I do hereby take responsibility for the daily monitoring and decision making in managing this student athlete's concussion.

 Healthcare Provider Signature HCP Printed Name AK License Number Date

SECTION 3: ATHLETE AND PARENT CONSENT

The **Return to Play Protocol** incorporates an internationally recognized process by which concussed athletes are returned to athletic participation as safely as possible. Participation in athletics is accompanied by the risk of injury, permanent disability, and death. Having recently sustained a concussion, an athlete is at more risk for another head injury with risk of permanent disability or death. By signing this form, the athlete and the parent indicate their understanding that the completion of the **Return to Play Protocol** is not a guarantee of safe return to athletic participation. The parent accepts the risk of additional injury in requesting and consenting to the athlete's return to athletic participation.

 Student Athlete Signature Date Parent Signature Date

 Student Athlete Printed Name Parent Printed Name

Use of Consultants at YKHC

MSEC approved 11/8/17 Updated 3/7/19

Phone Numbers
 ANMC: Consult: *97 or (907) 563-2662
 Transfer: (907) 729-2337
 PICU Cell for urgent consults: (907) 297-8809
 Providence: ED for on-call specialist: (907) 212-3111
 Trauma: (907) 212-2525
 Alaska Regional Hospital Access Center: (844) 880-5522
 VA/JBER: ED: MD consult number (907) 580-5556
 Transfer: (907) 580-6420
 Admissions 24/7 (907) 580-6423
 Operator: (907) 552-1110
 Harborview Seattle (burns): (888) 731-4791

Page the appropriate provider in Anchorage
 1. ANMC for beneficiaries
 2. Providence Hospital or Alaska Regional Hospital for non-beneficiaries
 3. Alaska Regional for prison inmate
 4. VA or JBER (Joint Base Elmendorf/Richardson) for veterans

Once speaking with the appropriate provider be able to:
 1. State your name, title and department (i.e. ER physician, outpatient NP, second year resident, etc)
 2. State purpose of call (i.e. quick question, possible admission, management advice.)
 3. Provide name, MRN, age, DOB. If the patient is pregnant, give gravity and parity and gestational age in initial sentence, if the patient is a child, give the age in the initial sentence.
 4. Be able to use the SBAR method to communicate patient details (see box below)
 5. Ask a **specific question** about management.
 6. Let accepting physicians know whether you think that the patient can travel by commercial flight or will require air medevac
 7. If there is a problem getting an accepting physician for a medevac/transfer or with patient management decisions, see NOTE below

Document consultant advice in the medical record, include date, time, first and last name of consultant and a summary of the advice given

Provider needs consultation about patient at YKHC

Consult provider is located in Bethel?

No

Yes

Patient is critically ill and the consultant is required at bedside?

No

Yes

Page provider STAT to come to bedside and assist in management.

If on-going management is required, a decision must be made **immediately** and **communicated** about who will be the primary managing provider giving orders and documenting in the medical record.

 Once patient is stabilized, discussion will occur between the primary provider and the consultant regarding documentation of the patient's medical care in the record and ongoing management.

If you're an SRC provider, you do not have the luxury of paging the provider STAT to bedside, for the purposes of this protocol, the SBAR case presentation and the documentation requirements apply.

Remember: Unless you transfer care of the patient, YOU are responsible for orders, documentation and notifying the patient and family of the plan of care.

Page the appropriate provider. Have ready the following information:
 1. State your name, title and department (i.e. ER physician, outpatient NP, second year resident, etc)
 2. State purpose of call (i.e. quick question, possible admission, management advice.)
 3. Name, MRN, age, DOB. If the patient is pregnant, give gravity and parity and gestational age in initial sentence, if the patient is a child, give the age in the initial sentence.
 4. Be able to use the SBAR method to communicate patient details (see box below)
 5. Ask a **specific question** about management.

Provider requesting consult must document consultant's advice in the medical record. Include date, time, first and last name of consultant and a summary of the advice given

At any time in the process, if the primary provider wants support at the bedside, page the consultant and ask them to come to bedside and provide support

 Clear role delineation must occur establishing who is the primary managing provider.

SBAR:
Situation: a concise statement of the problem, a "one-liner"
 "This is a 3 year old otherwise healthy girl with a fever..."
 "My patient is a 20 year old G3P2 at 26 weeks with vaginal bleeding..."
 "I'm taking care of a 21 year old male with fever and abdominal pain..."
Background: pertinent and brief information related to the situation
 "The labs are normal and CXR shows no infiltrate but her pulse is elevated..."
 "I have performed a sterile speculum exam and there is frank blood in the vault..."
 "The patient's CT show appendicitis and the patient is vomiting all intake..."
Assessment: analysis and consideration of options, what you found/think
 "I think she needs a fluid bolus but I am wondering if she also needs a UA..."
 "I think this patient might have an active abruption..."
 "I think this patient has appendicitis and needs to be transferred to ANMC..."
Recommendation: action requested, what you want
 "I want your opinion on how much fluid and the need for a UA..."
 "I want you to come in and asses this patient in person..."
 "I would like to transfer this patient via medevac to ANMC..."

NOTE:
 If there is a disagreement regarding the management of a patient between the consultant and the primary provider, the primary provider will advise the consultant as to the reason for the disagreement. If a consensus cannot be reached, a third opinion shall be obtained. This can either be from a YK based provider or from a provider from another facility. At any time the Clinical Director on call can also be notified.

CLINICAL GUIDELINES

2019

rev. 06-27-19

OB Guidelines

First Trimester Vaginal Bleeding: Ectopic	
Pregnancy Diagnosis & Treatment of Non-Viable Early Pregnancy	73
Ectopic Pregnancy – Treatment	76
Labor Patient – Village	77
Preterm Labor – Screening and Prevention	78
Preterm Labor – Evaluation	79
Preterm Labor – Treatment	80
Gestational Diabetes	81
Group B Streptococcus (GBS) – Maternal	82
Molar Pregnancy	83
Anemia in Pregnancy	84
Anti-D Immune Globulin	85
Intrauterine Growth Restriction (IUGR)	86
Oligohydramnios.....	87
Post Dates Pregnancy.....	88
Induction of Labor.....	89
Intrahepatic Cholestasis of Pregnancy (IHCP).....	90
Chronic Hypertension in Pregnancy	91
Gestational Hypertension	92
Preterm Premature Rupture of Membranes	93
Vaginal Birth After Cesarean.....	94

First Trimester Vaginal Bleeding: Ectopic Pregnancy Diagnosis & Treatment of Non-Viable Early Pregnancy, p.1

MSEC approved 07/12/17

1
Nomenclature

- **Viable** – A pregnancy is viable if it can potentially result in a liveborn baby.
- **Nonviable** – A pregnancy is nonviable if it cannot possibly result in a liveborn baby. Ectopic pregnancies and failed intrauterine pregnancies are nonviable
- **Intrauterine pregnancy of uncertain viability** – A woman is considered to have this if a transvaginal US shows an intrauterine gestational sac with no embryonic heartbeat and no findings of definite pregnancy failure
- **Pregnancy of unknown location** – A woman is considered to have this if she has a positive urine or serum pregnancy test and no intrauterine or ectopic pregnancy on transvaginal US

2
Findings diagnostic of Pregnancy Failure

- Crown-rump length of ≥ 7 mm and no heartbeat
- Mean sac diameter of ≥ 25 mm and no embryo
- Absence of embryo with heartbeat ≥ 14 days after an US that showed a gestational sac without a yolk sac
- Absence of embryo with a heartbeat ≥ 11 days after an US that showed a gestational sac with a yolk sac

Comments

- In a woman with a positive urine or serum pregnancy test, an intrauterine fluid collection with rounded edges containing no yolk sac is most likely a gestational sac; it is certain to be a gestational sac if it contains a yolk sac or embryo.
- Transabdominal imaging without transvaginal scanning may be sufficient for diagnosing early pregnancy failure when an embryo whose crown-rump length is 15mm or more has no visible cardiac activity.

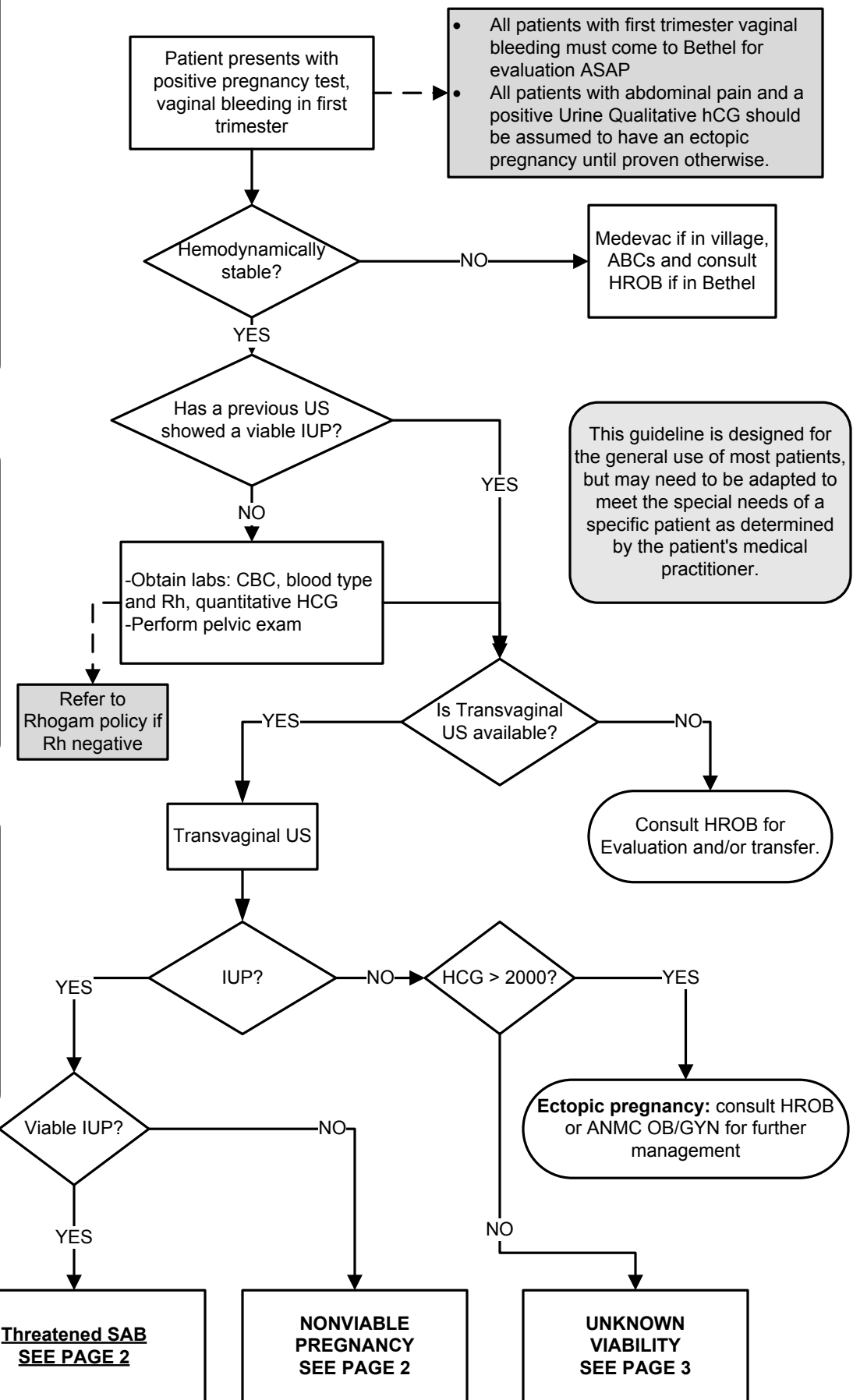

- All patients with first trimester vaginal bleeding must come to Bethel for evaluation ASAP
- All patients with abdominal pain and a positive Urine Qualitative hCG should be assumed to have an ectopic pregnancy until proven otherwise.

This guideline is designed for the general use of most patients, but may need to be adapted to meet the special needs of a specific patient as determined by the patient's medical practitioner.

First Trimester Vaginal Bleeding: Ectopic Pregnancy Diagnosis & Treatment of Non-Viable Early Pregnancy, p.2

MSEC approved 07/12/17

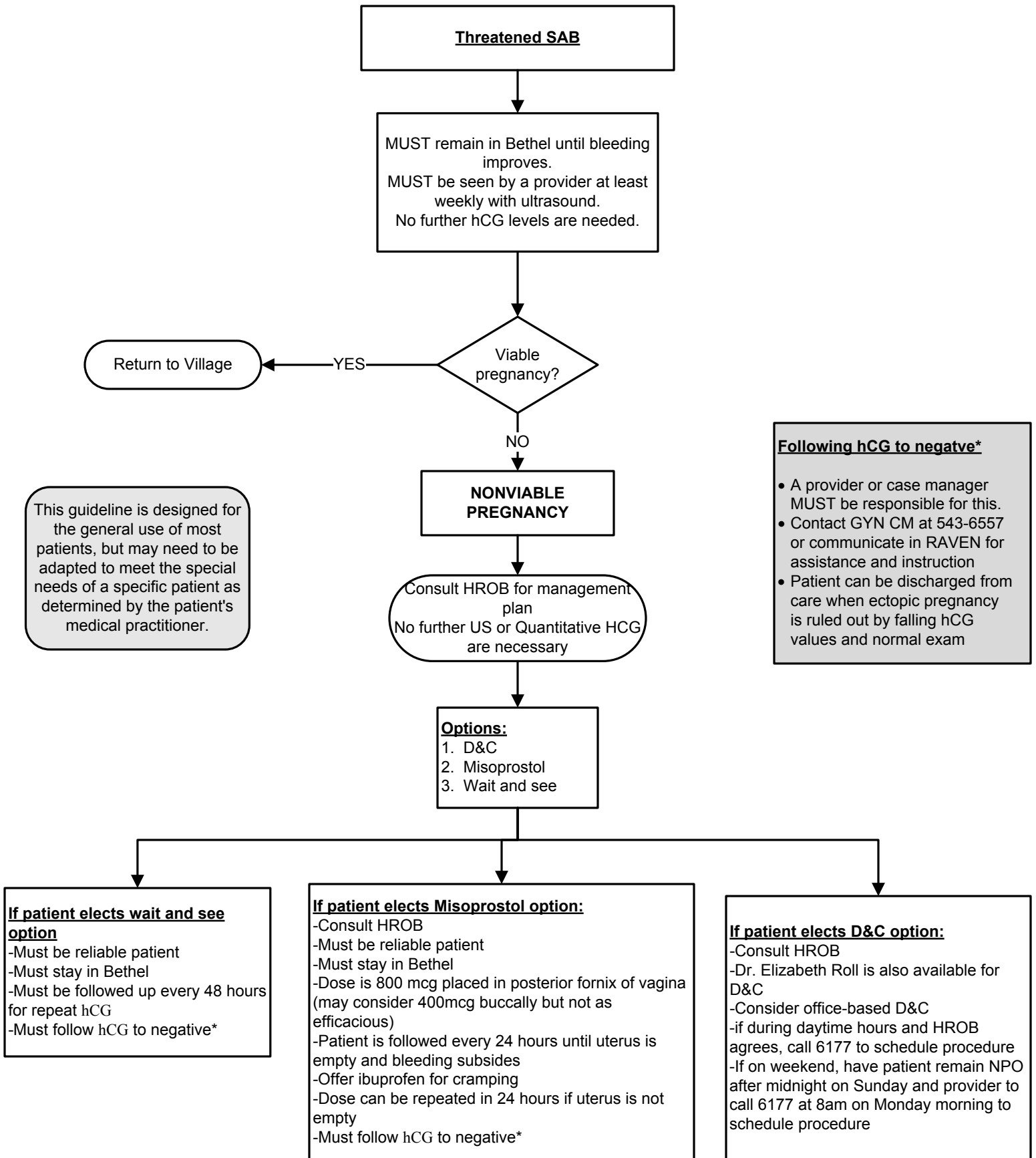

Threatened SAB

MUST remain in Bethel until bleeding improves.
MUST be seen by a provider at least weekly with ultrasound.
No further hCG levels are needed.

Viable pregnancy?

Return to Village

YES

NO

NONVIALE PREGNANCY

Consult HROB for management plan
No further US or Quantitative HCG are necessary

Options:
1. D&C
2. Misoprostol
3. Wait and see

If patient elects wait and see option

- Must be reliable patient
- Must stay in Bethel
- Must be followed up every 48 hours for repeat hCG
- Must follow hCG to negative*

If patient elects Misoprostol option:

- Consult HROB
- Must be reliable patient
- Must stay in Bethel
- Dose is 800 mcg placed in posterior fornix of vagina (may consider 400mcg buccally but not as efficacious)
- Patient is followed every 24 hours until uterus is empty and bleeding subsides
- Offer ibuprofen for cramping
- Dose can be repeated in 24 hours if uterus is not empty
- Must follow hCG to negative*

If patient elects D&C option:

- Consult HROB
- Dr. Elizabeth Roll is also available for D&C
- Consider office-based D&C
- if during daytime hours and HROB agrees, call 6177 to schedule procedure
- If on weekend, have patient remain NPO after midnight on Sunday and provider to call 6177 at 8am on Monday morning to schedule procedure

This guideline is designed for the general use of most patients, but may need to be adapted to meet the special needs of a specific patient as determined by the patient's medical practitioner.

Following hCG to negative*

- A provider or case manager MUST be responsible for this.
- Contact GYN CM at 543-6557 or communicate in RAVEN for assistance and instruction
- Patient can be discharged from care when ectopic pregnancy is ruled out by falling hCG values and normal exam

First Trimester Vaginal Bleeding: Ectopic Pregnancy Diagnosis & Treatment of Non-Viable Early Pregnancy, p.3

MSEC approved 07/12/17

1 Nomenclature

- **Viable** – A pregnancy is viable if it can potentially result in a liveborn baby.
- **Nonviable** – A pregnancy is nonviable if it cannot possibly result in a liveborn baby. Ectopic pregnancies and failed intrauterine pregnancies are nonviable
- **Intrauterine pregnancy of uncertain viability** – A woman is considered to have this if a transvaginal US shows an intrauterine gestational sac with no embryonic heartbeat and no findings of definite pregnancy failure
- **Pregnancy of unknown location** – A woman is considered to have this if she has a positive urine or serum pregnancy test and no intrauterine or ectopic pregnancy on transvaginal US

2 Findings diagnostic of Pregnancy Failure

- Crown-rump length of ≥ 7 mm and no heartbeat
- Mean sac diameter of ≥ 25 mm and no embryo
- Absence of embryo with heartbeat ≥ 14 days after an US that showed a gestational sac without a yolk sac
- Absence of embryo with a heartbeat ≥ 11 days after an US that showed a gestational sac with a yolk sac

Comments

- In a woman with a positive urine or serum pregnancy test, an intrauterine fluid collection with rounded edges containing no yolk sac is most likely a gestational sac; it is certain to be a gestational sac if it contains a yolk sac or embryo.
- Transabdominal imaging without transvaginal scanning may be sufficient for diagnosing early pregnancy failure when an embryo whose crown-rump length is 15mm or more has no visible cardiac activity.

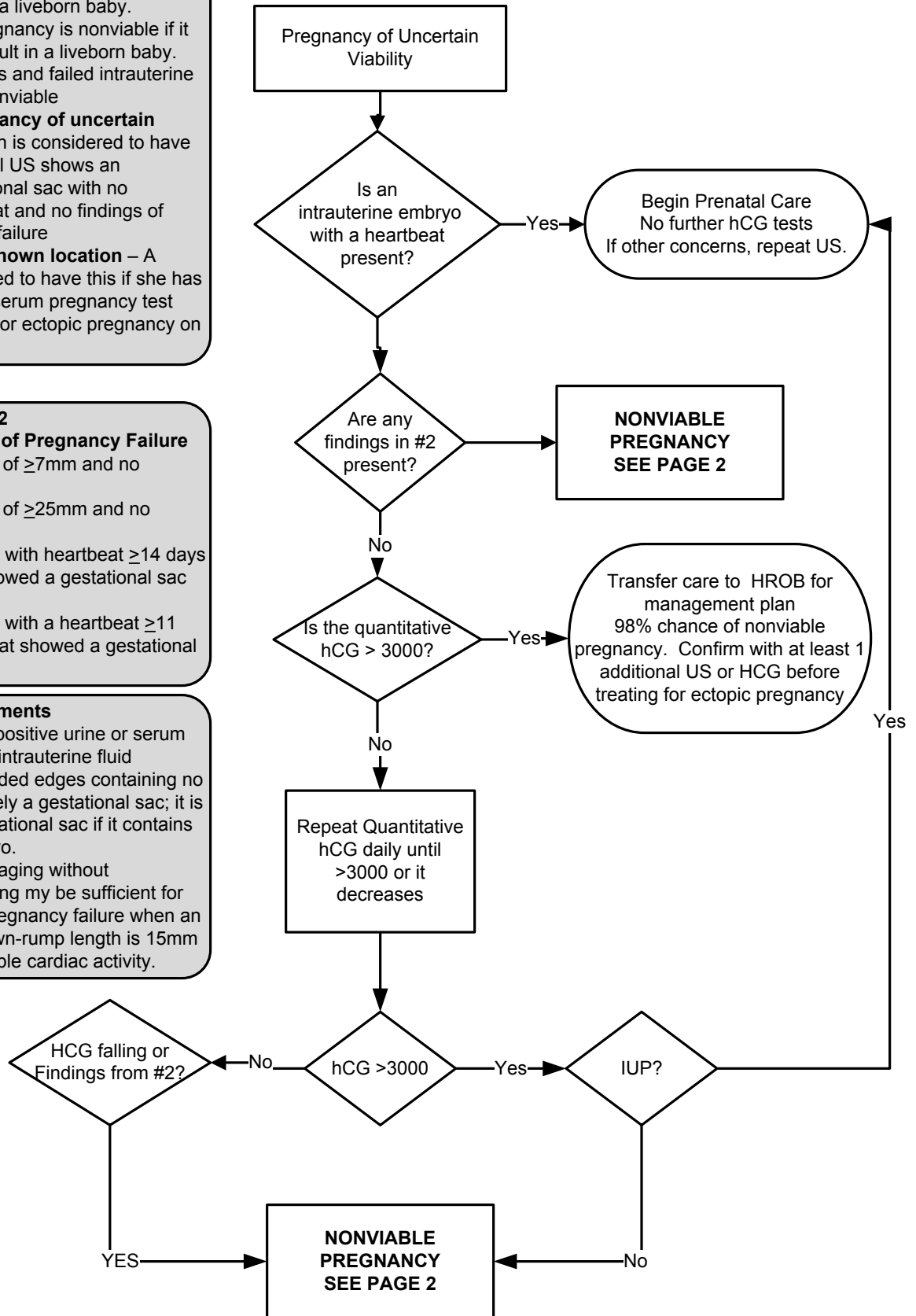

Ectopic Pregnancy – Treatment

MSEC approved 07/12/17

D&C Prior to Methotrexate?
 This is NOT necessary prior to treatment with Methotrexate (MTX) for a plateau or abnormally rising HCG level. MTX will treat an abnormal pregnancy in the uterus or any other location.

Typical side effects of MTX.
 Less than 30% of patients will experience side effects from the medication and those are minor and self limited. These include: nausea, mouth ulcers GI cramps. Most patients have some lower abdominal pain on the 3-6th day after treatment. This is not a problem if ibuprofen or acetaminophen relieves the pain.

Contraindication to MTX.
Absolute contraindications
 Breast Feeding
 Overt or Laboratory evidence of immunodeficiency
 Alcoholism, alcoholic liver disease, or other chronic liver disease
 Preexisting blood dyscrasias, such as bone marrow hypoplasia, leukopenia, thrombocytopenia or significant anemia
 Known sensitivity to MTX
 Active pulmonary disease
 Peptic ulcer disease
 Hepatic, renal or hematologic dysfunction
Relative contraindications
 Gestational sac larger than 3.5cm
 Embryonic cardiac motion

Ectopic Pregnancy diagnosed after consultation with HROB or OB/GYN

Obtain:
 • Quantitative HCG
 • Type and Screen
 • CBC
 • Comp Chem.
 • Transvaginal Pelvic Ultrasound (US)

Hemodynamically stable?

Consult HROB for immediate surgery or transfer

Adnexal Mass \geq 3cm Cardiac activity
 Pregnancy in location other than a tube

Platelets, Kidney and Liver function Normal?

Single-dose regimen
 • Single dose MTX 50mg/m² IM day 1
 • Measure hCG level on post treatment days 4 and 7
 • Check for 15% hCG decrease between days 4 and 7
 • Then measure hCG level weekly until reaching the nonpregnant level
 • If results are less than the expected 15% decrease, readminister MTX 50mg/m² and repeat hCG measurement on days 4 and 7 after second dose.

Two-dose regimen
 • Administer 50 mg/m² on day 0.
 • Repeat 50mg/m² on day 4.
 • Measure hCG levels on days 4 and 7, and expect a 15% decrease between days 4 and 7.
 • If the decrease is greater than 15%, measure hCG levels weekly until reaching non pregnant level.
 • If less than a 15% decrease in hCG levels, readminister MTX 50mg/m² on days 7 and 11, measuring hCG levels.
 • If hCG levels decrease 15% between days 7 and 11, continue to monitor weekly until non pregnant hCG levels are reached.

If at any time the hCG level rises during the monitoring of weekly hCG levels, consult a GYN Oncologist for further treatment.

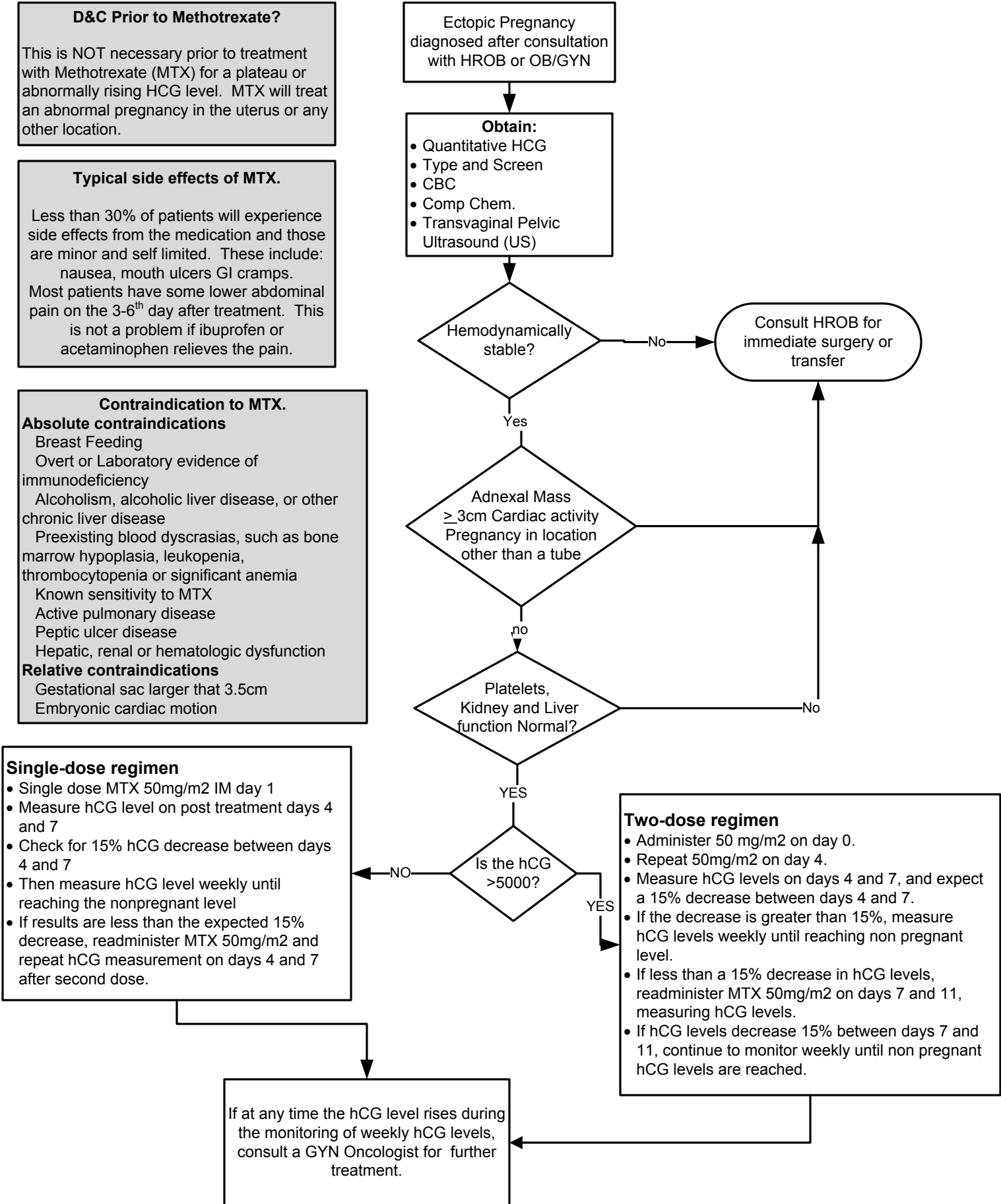

Labor Patient – Village

MSEC approved 12/14/16

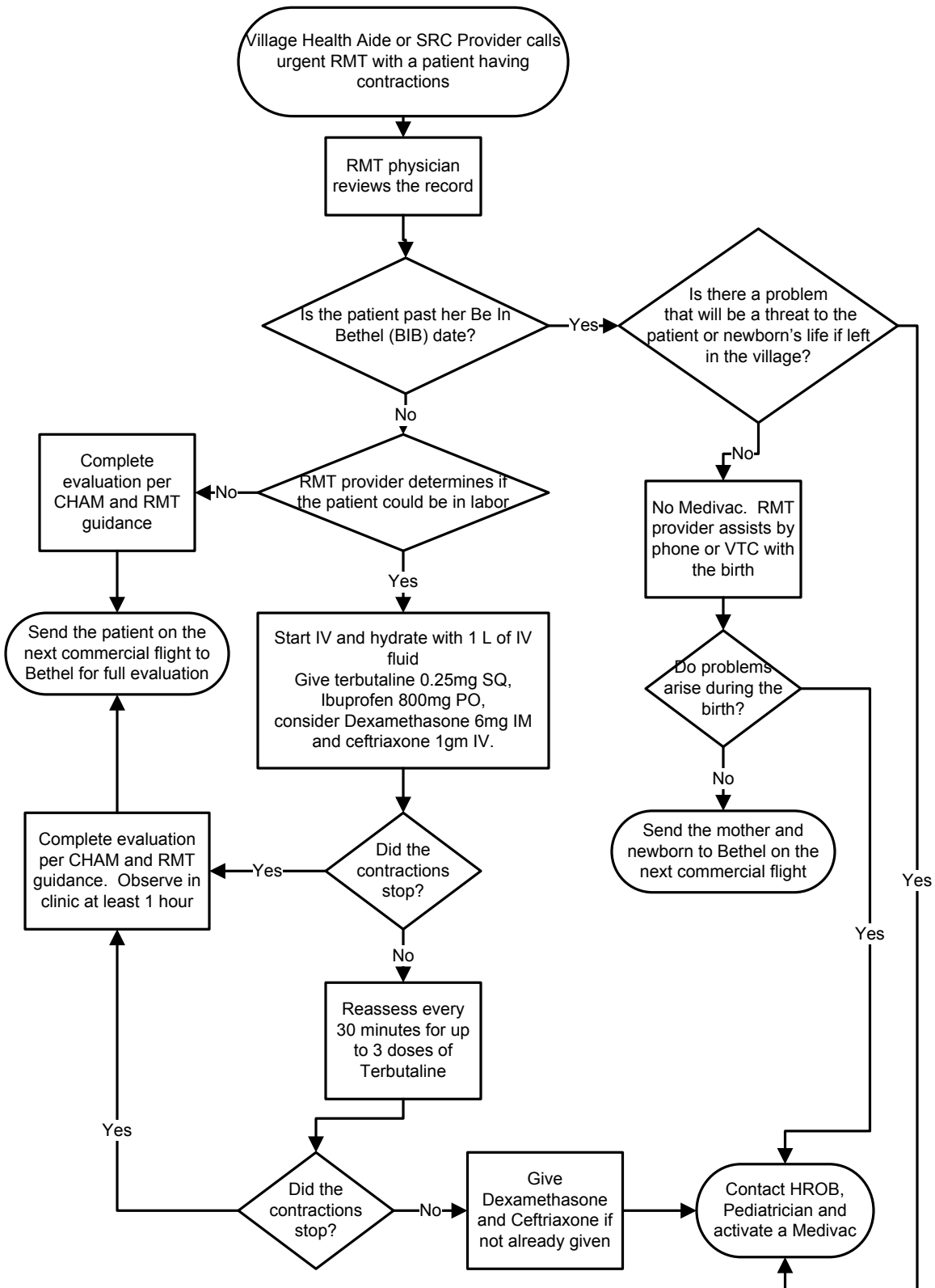

Preterm Labor – Screening and Prevention

MSEC approved 8/24/16

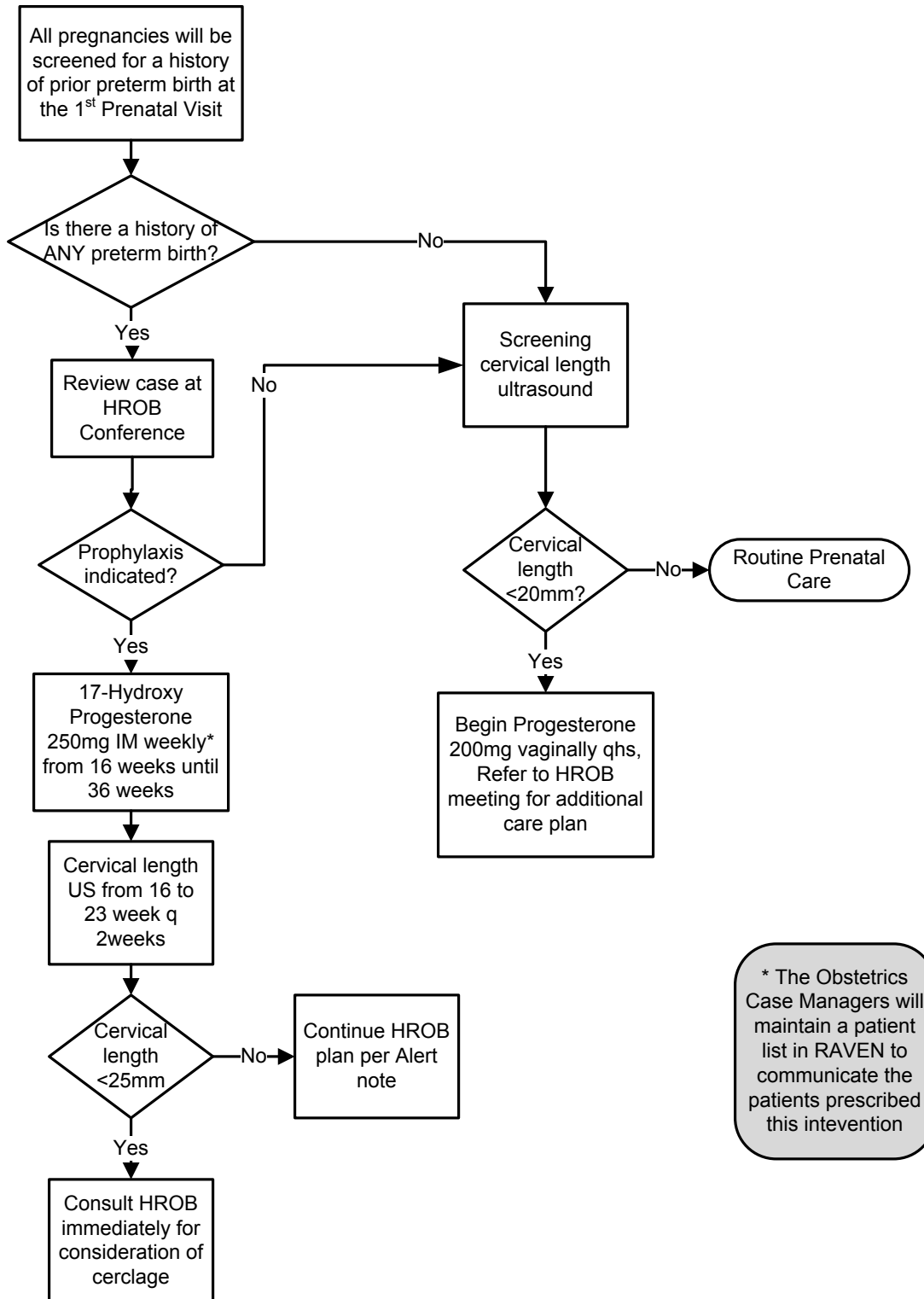

Preterm Labor – Evaluation

MSEC approved 07-12-17

- Preterm Labor Symptoms**
- Increased vaginal discharge
 - Blood tinged mucus
 - Low backache
 - Pelvic pressure
 - Menstrual-like cramps
 - Intestinal cramping with or without diarrhea
 - “Not feeling right”
 - Loss of cervical mucous/ “plug”

Definition of Preterm Labor-regular uterine contractions after 20 weeks gestation and before 37 weeks gestation which lead to a progressive cervical change

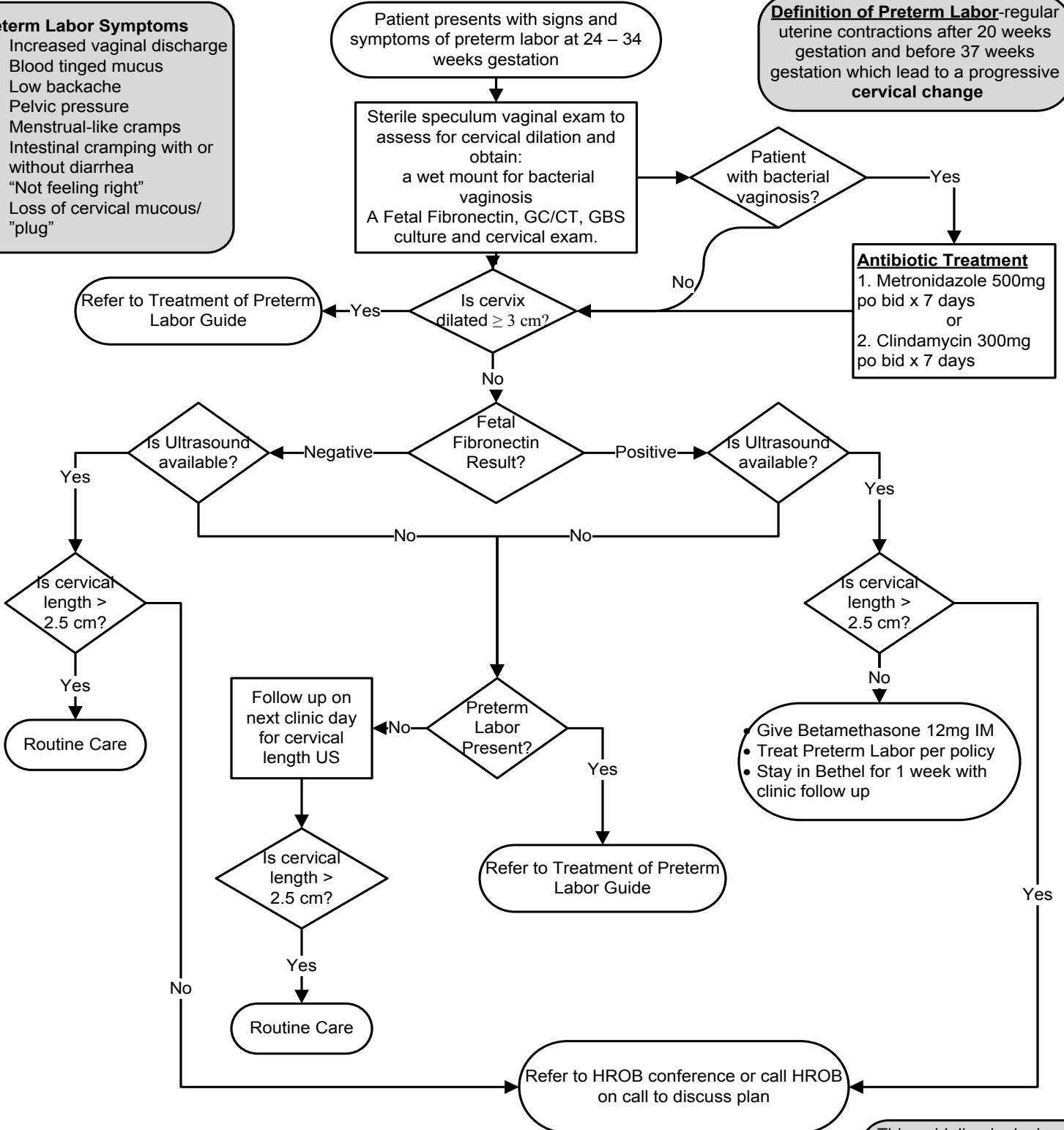

There is no need to treat contractions with tocolytics in the absence of cervical change

This guideline is designed for general use for most patients but may need to be adapted to meet the special needs of a specific patient as determined by the patient’s provider

Preterm Labor – Treatment

MSEC approved 7/12/17

Definition of Preterm Labor-regular uterine contractions after 20 weeks gestation and before 37 weeks gestation which lead to a progressive cervical change

- Contraindications to tocolysis:**
- IUFD
 - Lethal fetal anomaly
 - Non-reassuring fetal assessment
 - Severe IUGR
 - Chorioamnionitis, relative
 - Maternal hemorrhage with hemodynamic instability
 - Severe preeclampsia or eclampsia
 - PPROM

- Contraindications to terbutaline**
- Diabetes
 - HTN
 - Suspected placental abruption (relative)

This guideline is designed for the general use of most patients, but may need to be adapted to meet the special needs of a specific patient as determined by the patient's medical practitioner.

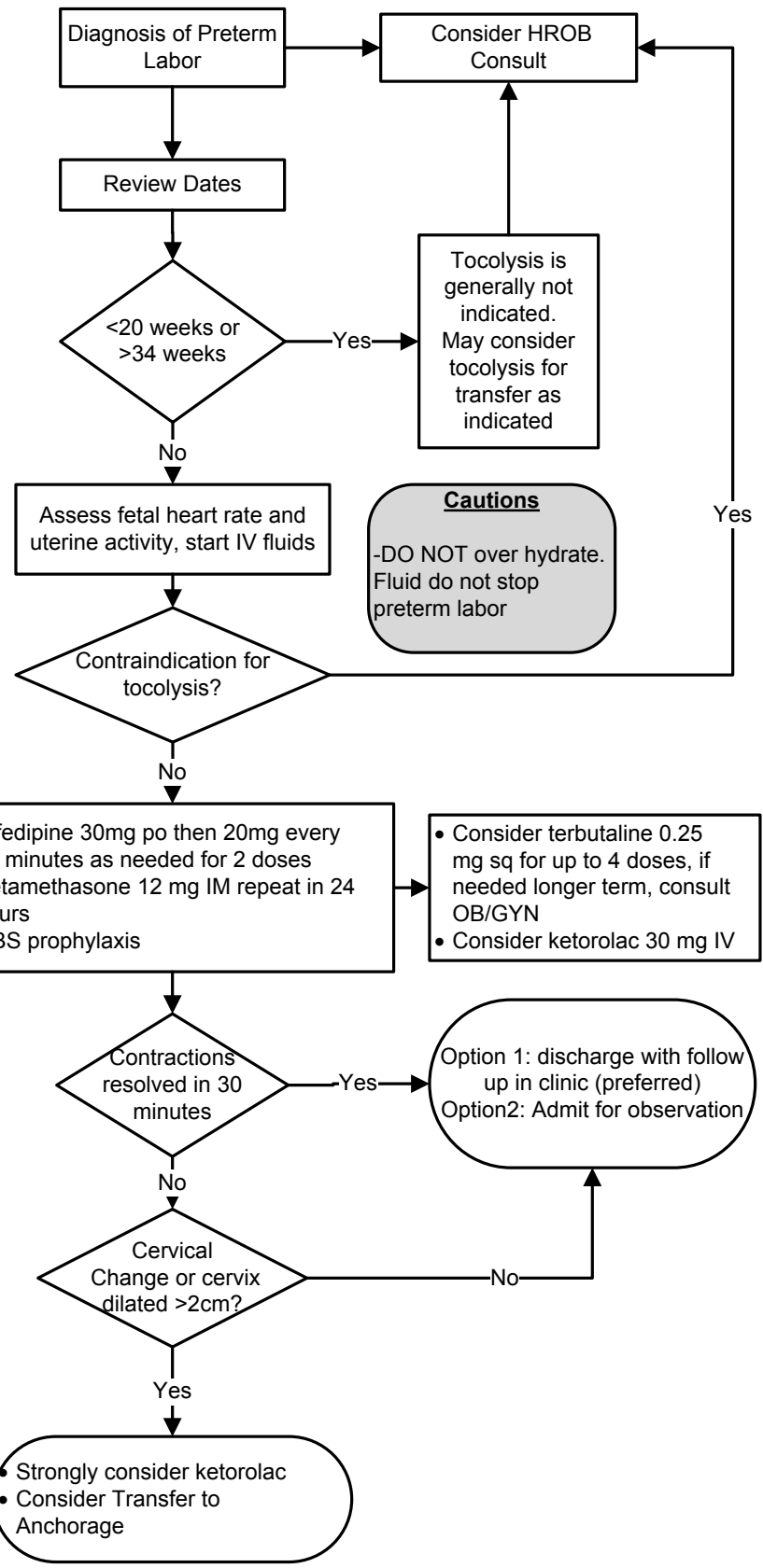

Cautions

- DO NOT over hydrate.
- Fluid do not stop preterm labor

Gestational Diabetes

MSEC approved 07-12-17

This guideline is designed for the general use of most patients, but may need to be adapted to meet the special needs of a specific patient as determined by the patient's medical practitioner.

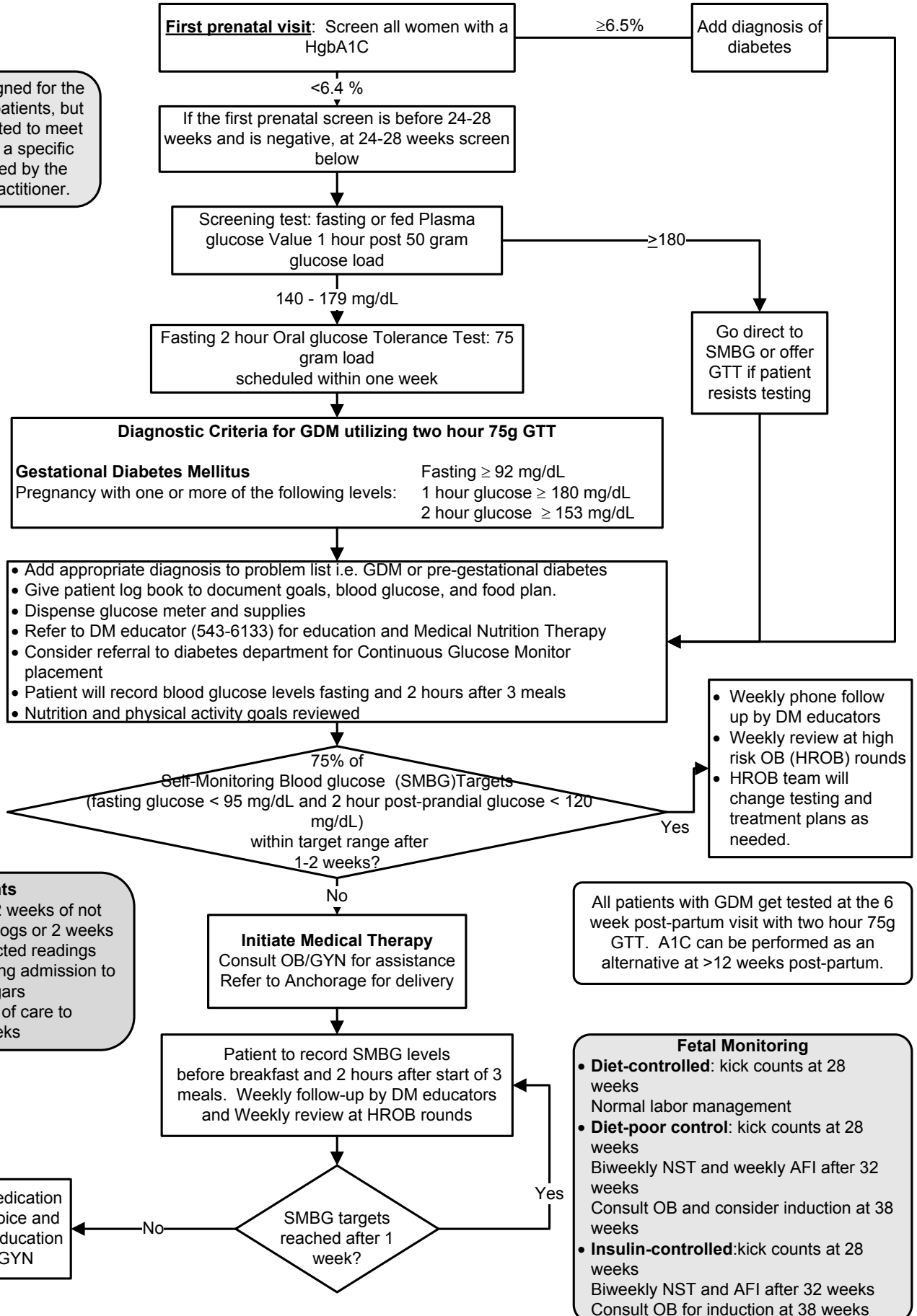

Non-Adherent Patients

- Send letter after 2 weeks of not sending in sugar logs or 2 weeks of <25 % of expected readings
- Consider Northwing admission to monitor blood sugars
- Consider transfer of care to ANTHC at 32 weeks

All patients with GDM get tested at the 6 week post-partum visit with two hour 75g GTT. A1C can be performed as an alternative at >12 weeks post-partum.

Fetal Monitoring

- **Diet-controlled:** kick counts at 28 weeks
Normal labor management
- **Diet-poor control:** kick counts at 28 weeks
Biweekly NST and weekly AFI after 32 weeks
Consult OB and consider induction at 38 weeks
- **Insulin-controlled:** kick counts at 28 weeks
Biweekly NST and AFI after 32 weeks
Consult OB for induction at 38 weeks

Group B Streptococcus (GBS) – Maternal

MSEC approved 7/12/17

GBS Prophylaxis of the Mother at Term

Use the
GBS App

to determine need for prophylaxis and antibiotic of choice for GBS prevention

Web version: <https://www2a.cdc.gov/vaccines/m/gbs3/gbs.html>

Or

Download for your smartphone

Molar Pregnancy

MSEC approved 07/12/17

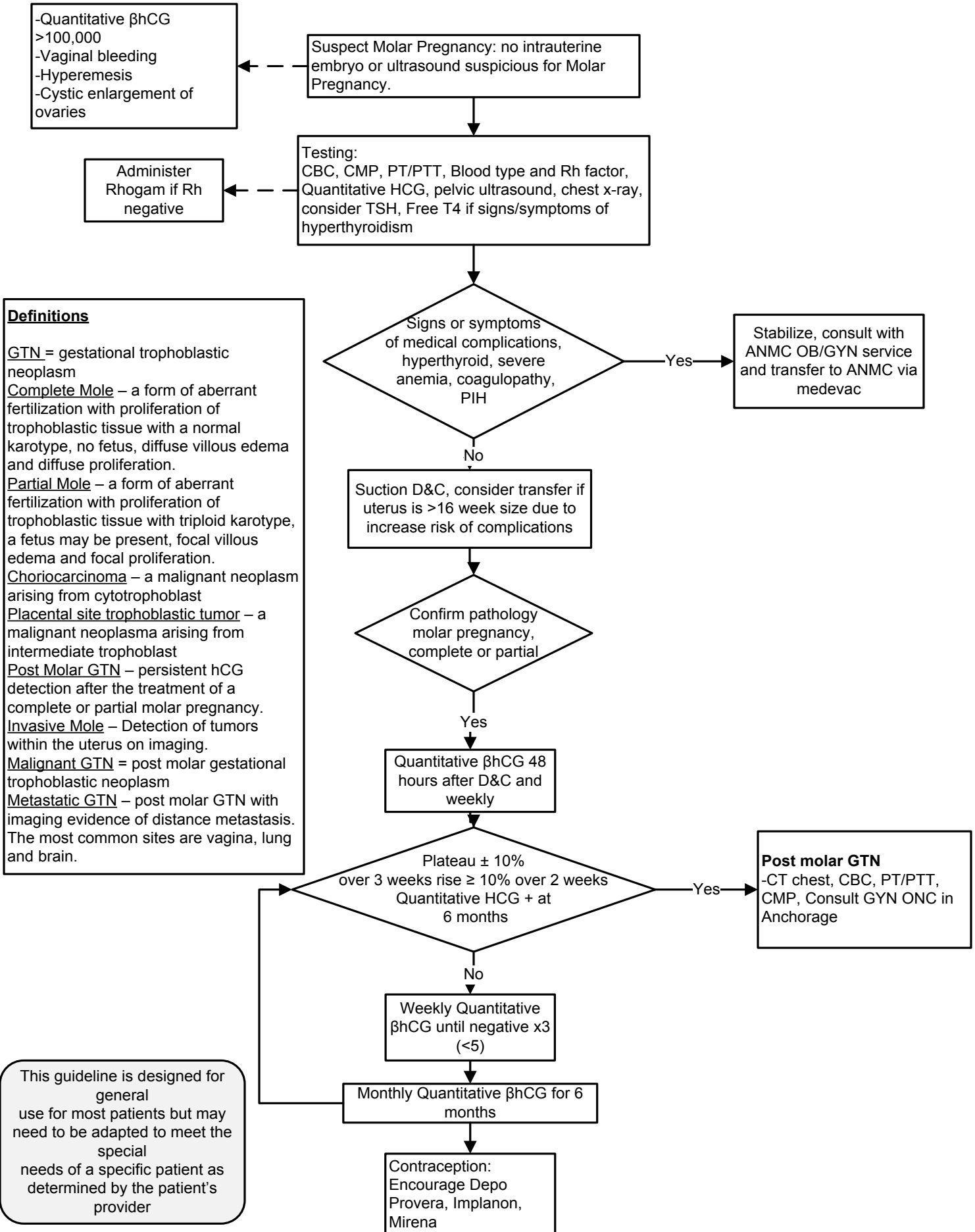

Anemia in Pregnancy

MSEC approved 07/12/17

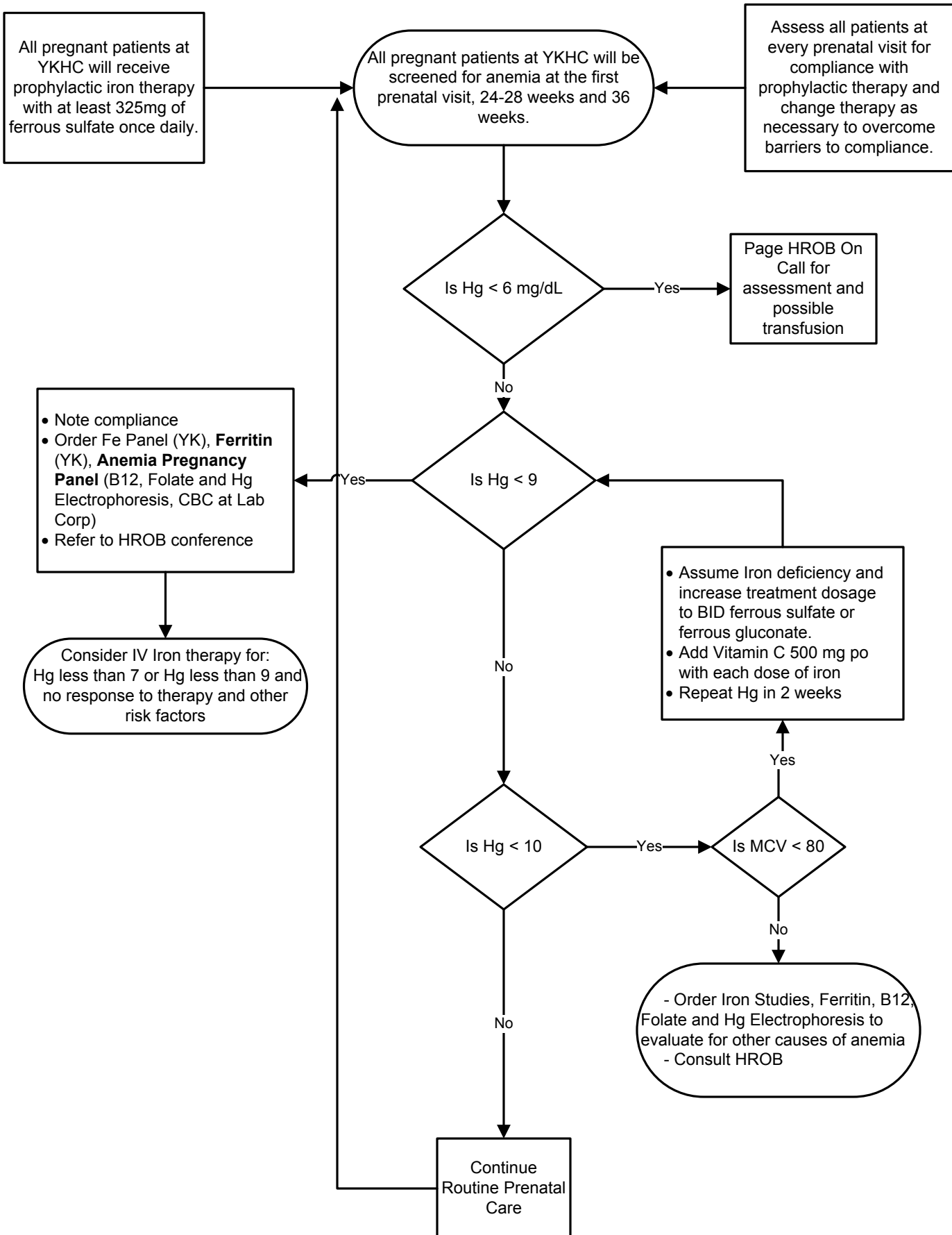

Anti-D Immune Globulin

rev 10-30-17

Reference Lab Policy
Rh Immune Globulin Work-up
Fetal Screen

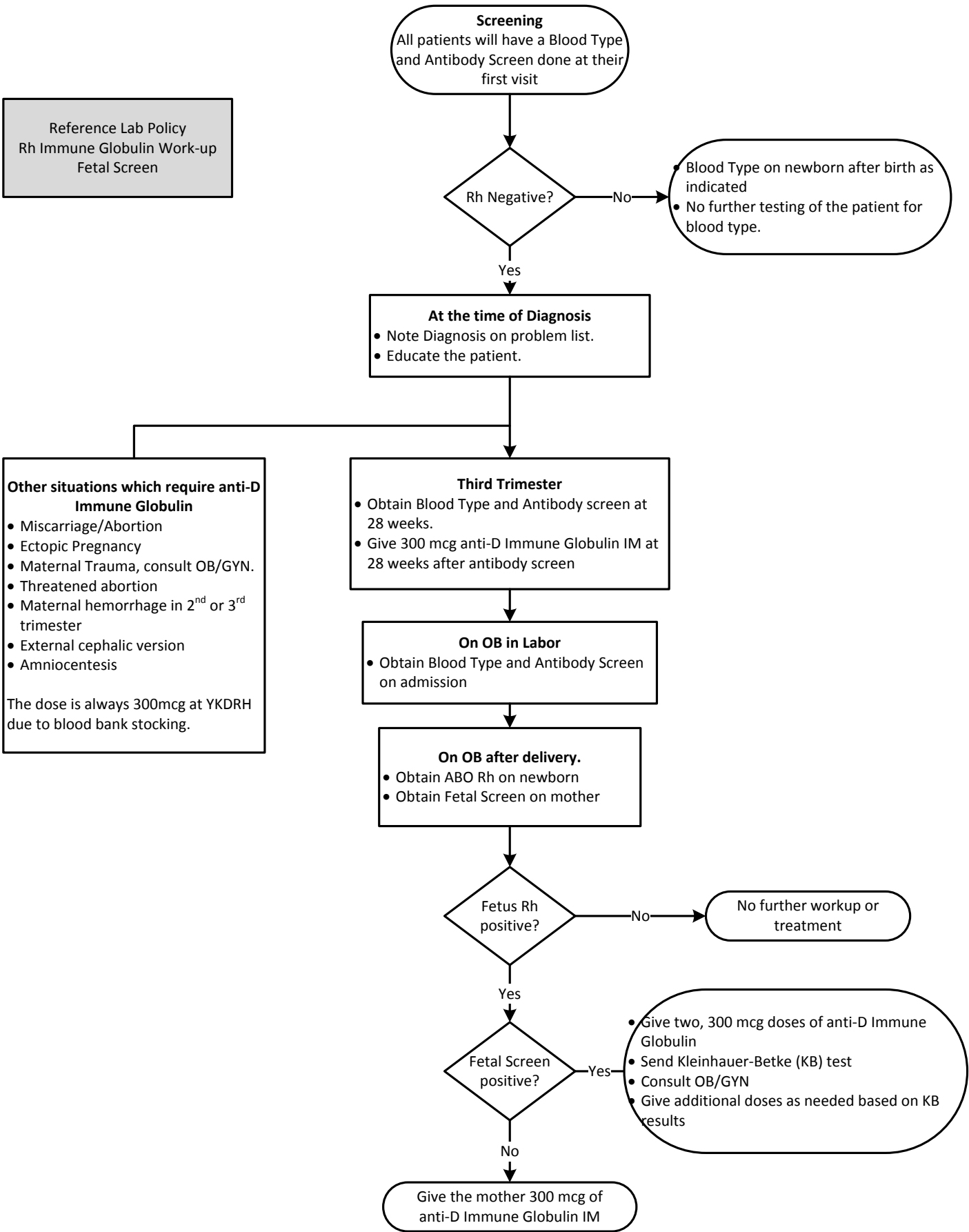

Intrauterine Growth Restriction (IUGR)

MSEC approved 07/12/17

Risk Factors for Intrauterine Growth Restriction

- **Maternal medical conditions**
 - Hypertension
 - Renal disease
 - Restrictive lung disease
 - Diabetes (with microvascular disease)
 - Cyanotic heart disease
 - Antiphospholipid syndrome
 - Auto-immune disease
- Smoking and substance use and abuse
- Severe malnutrition
- Primary placental disease
- Multiple gestation
- Infections (viral, protozoal)
- Genetic disorders
- Exposure to teratogens

Definition of IUGR

Estimated Fetal Weight by ultrasound < 10th percentile by gestational age

IUGR is suspected by physical examination (fundal height 3cm or more smaller than dates) and/or risk factors

Obtain an US:

- Include all growth measurements with EFW and percentile
- Include reflex Doppler parameters:
 - Systolic to diastolic ratio of umbilical artery (S/D-UA)
 - Pulsatility index of the umbilical artery (PI-UA)



Routine Prenatal Care

Repeat US in 4 weeks. Consider weekly fetal monitoring with BPP if EFW > 10th percentile but < 25th percentile

Consult HROB or Anchorage OB to discuss induction, monitoring, or transfer



Box 1

NIPT – Non-invasive prenatal testing is a way to detect Fetal chromosome abnormalities from a maternal blood draw. Our current test is the InformaSeq from LabCorp.

Oligohydramnios

MSEC approved 07/12/17

Differential Diagnosis by Trimester

First

- Aneuploidy
- Fetal Anomaly

Second

- Aneuploidy
- Fetal Anomaly
- Preterm premature rupture of membranes (PPROM)
- Placental abruption
- Fetal growth restriction
- Amniocentesis
- Elevated maternal serum alpha fetoprotein

Third

- Preterm premature rupture of membranes
- Placental abruption
- Fetal growth restriction
- Utero-placental insufficiency
- Preeclampsia
- Maternal vascular diseases
- Fetal anomaly
- Post-term
- Suboptimal maternal hydration

Definition of Oligohydramnios

Amniotic Fluid Volume (AFI) < 5 at term
or
Single Vertical Pocket < 2cm

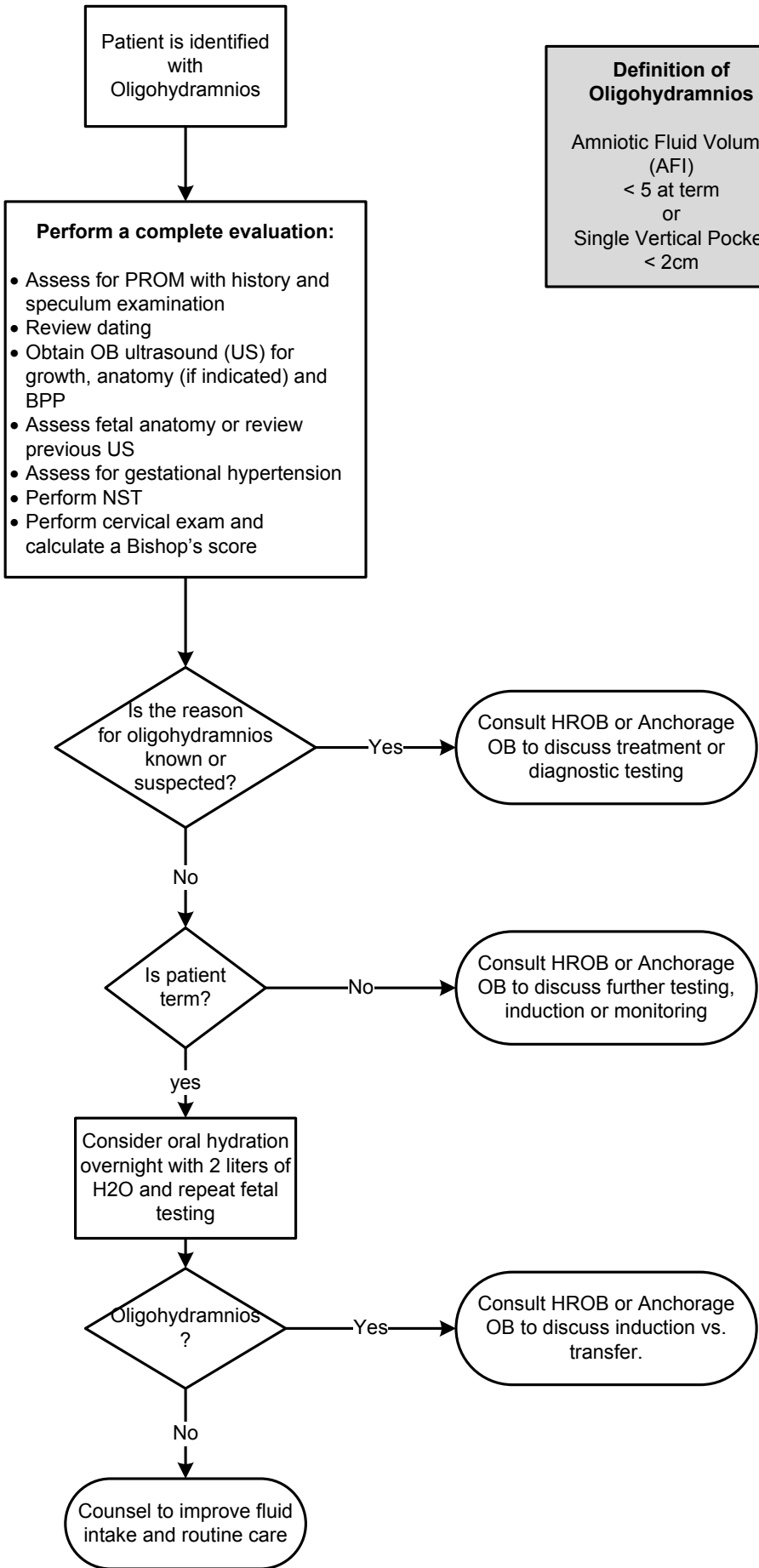

Post Dates Pregnancy

MSEC approved 06/22/11

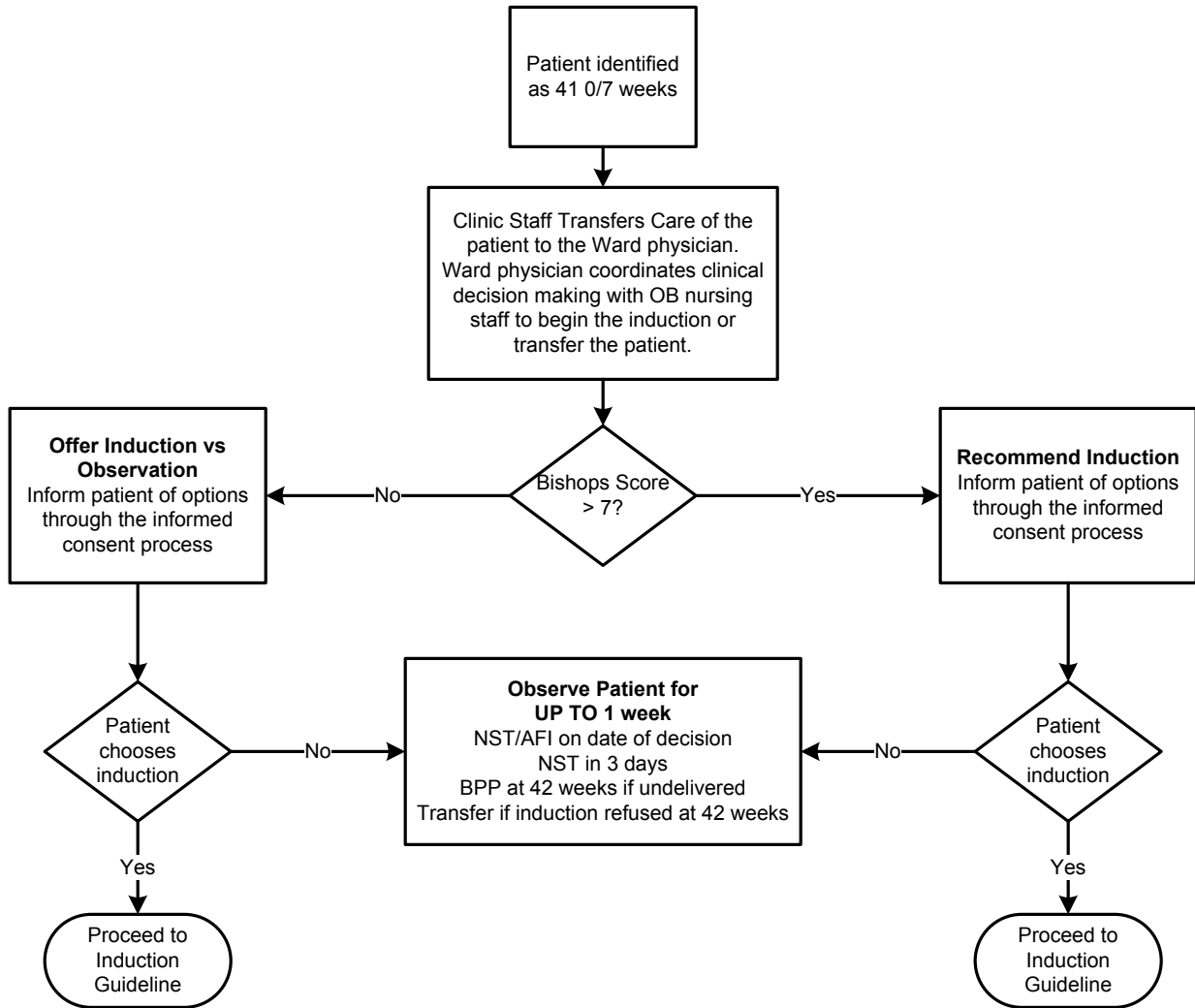

Bishops Score					
Score	Dilatation	Effacement	Station	Position	Consistency
0	closed	0 – 30%	-3	posterior	firm
1	1-2 cm	40 -50%	-2	mid-position	medium
2	3-4 cm	60 -70%	-1,0	anterior	soft
3	5+ cm	80+%	+1,+2		

This guideline is designed for the general use of most patients, but may need to be adapted to meet the special needs of a specific patient as determined by the patient's medical practitioner

Induction of Labor

MSEC approved 12/14/16

Induction time frames for Diagnoses:

- Preeclampsia or Gestational Hypertension: 38 weeks, must be delivered or transferred by due date
- Preeclampsia or Gestational Hypertension with severe features: Medical Evacuation to Anchorage
- Chronic Hypertension: 39 weeks, must be delivered or transferred by due date
- IHCP Mild: 39 weeks,
- IHCP Severe: must be transferred prior to 37 weeks or induced or transferred immediately if diagnosed after 37 weeks.
- Post Dates: 41 weeks. Consult HROB if patient declines induction.
- History of Stillbirth: 38 weeks

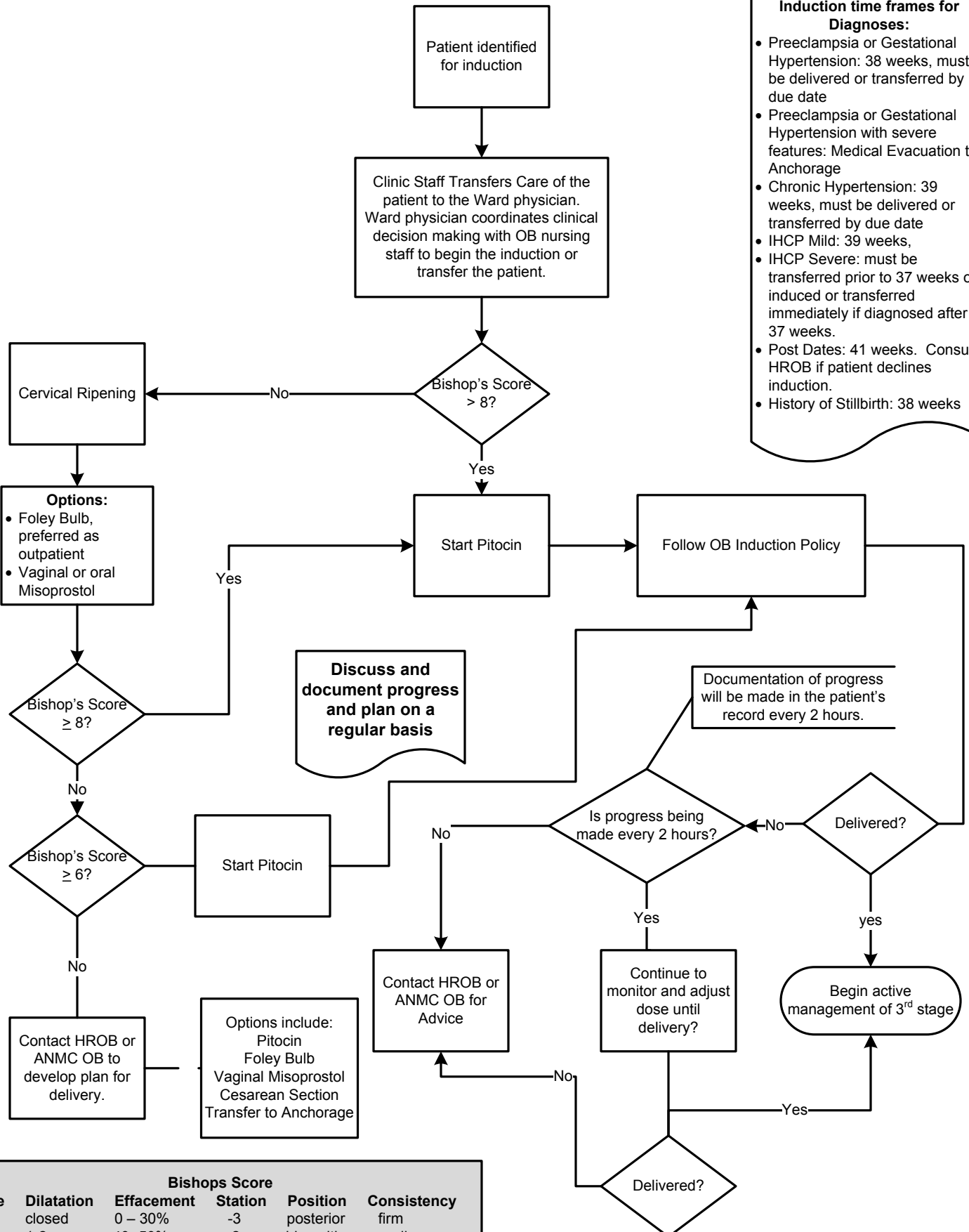

Bishops Score					
Score	Dilatation	Effacement	Station	Position	Consistency
0	closed	0 – 30%	-3	posterior	firm
1	1-2 cm	40 -50%	-2	mid-position	medium
2	3-4 cm	60 -70%	-1,0	anterior	soft
3	5+ cm	80+%	+1,+2		

Intrahepatic Cholestasis of Pregnancy (IHCP)

MSEC approved 12/14/16

This guideline is designed for the general use of most patients, but may need to be adapted to meet the special needs of a specific patient as determined by the patient's medical practitioner.

Severe Pruritus:

- Insomnia
- Worse on palms of hands and soles of feet
- Excoriation present
- Scratching during the exam.

Intrahepatic Cholestasis of Pregnancy (IHCP)

- Abnormal Bile Acids (BA) metabolism in pregnancy resulting in severe pruritus without rash
- Mostly genetic etiology
- 5% incidence in Yup'ik population
- 5% incidence of Stillbirth
- MUST have elevated bile acids or LFTs
- 40-70% recurrence in subsequent pregnancies

Early Pregnancy: Consider the diagnosis if:

- History of severe pruritus in past pregnancy
- Unexplained stillbirth
- Hx of IHCP

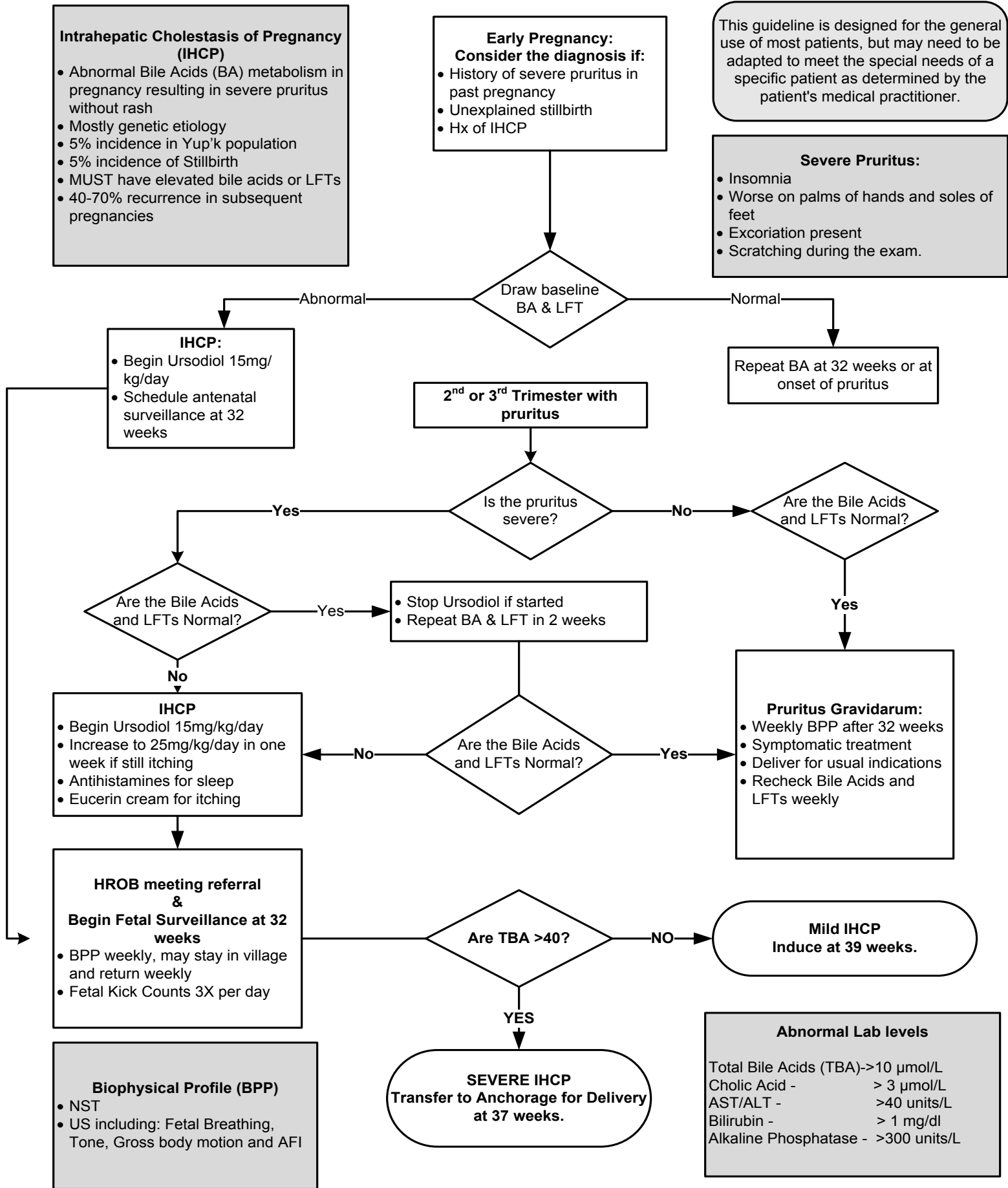

Chronic Hypertension in Pregnancy

MSEC approved 07/12/17

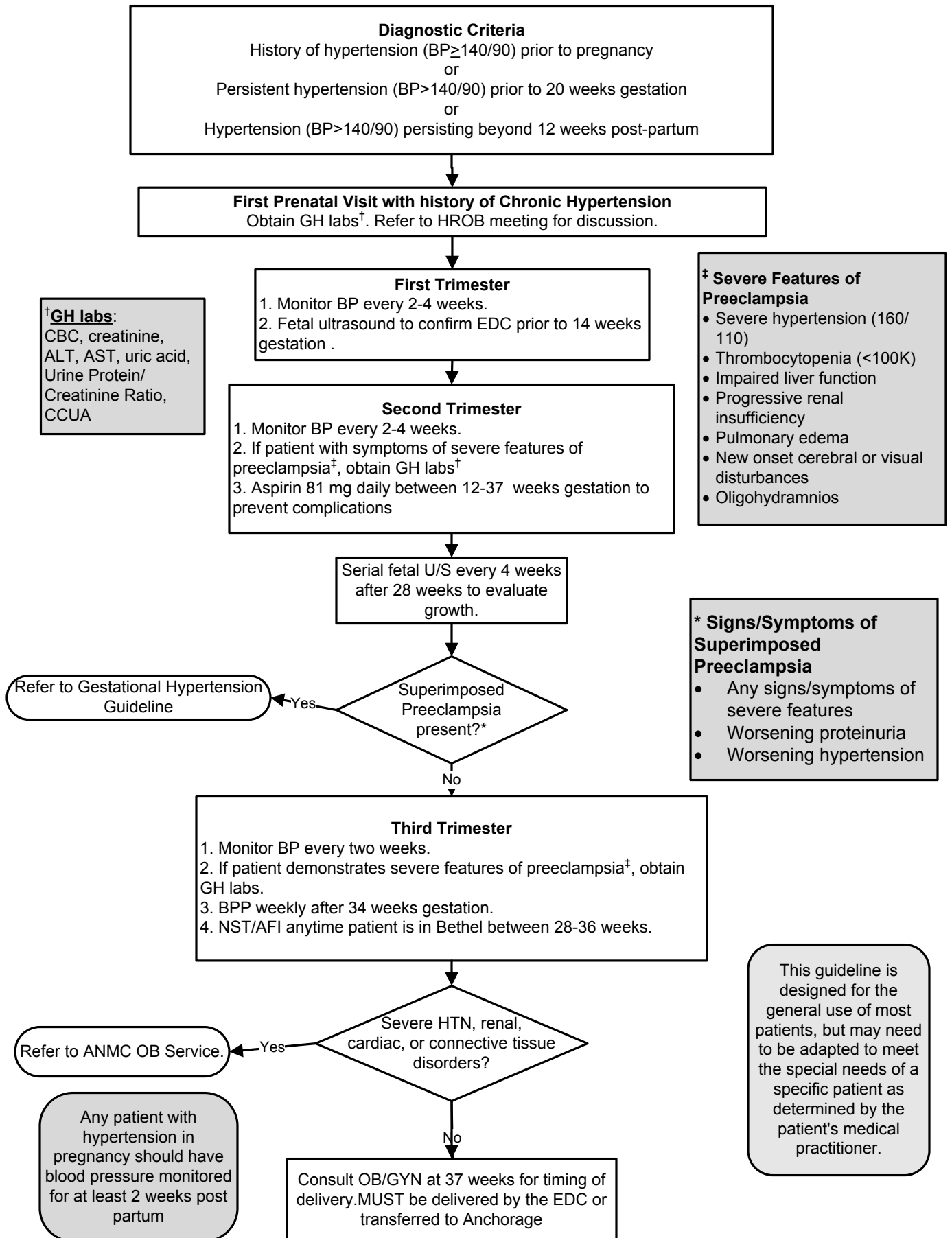

Gestational Hypertension

MSEC approved 07-12-17

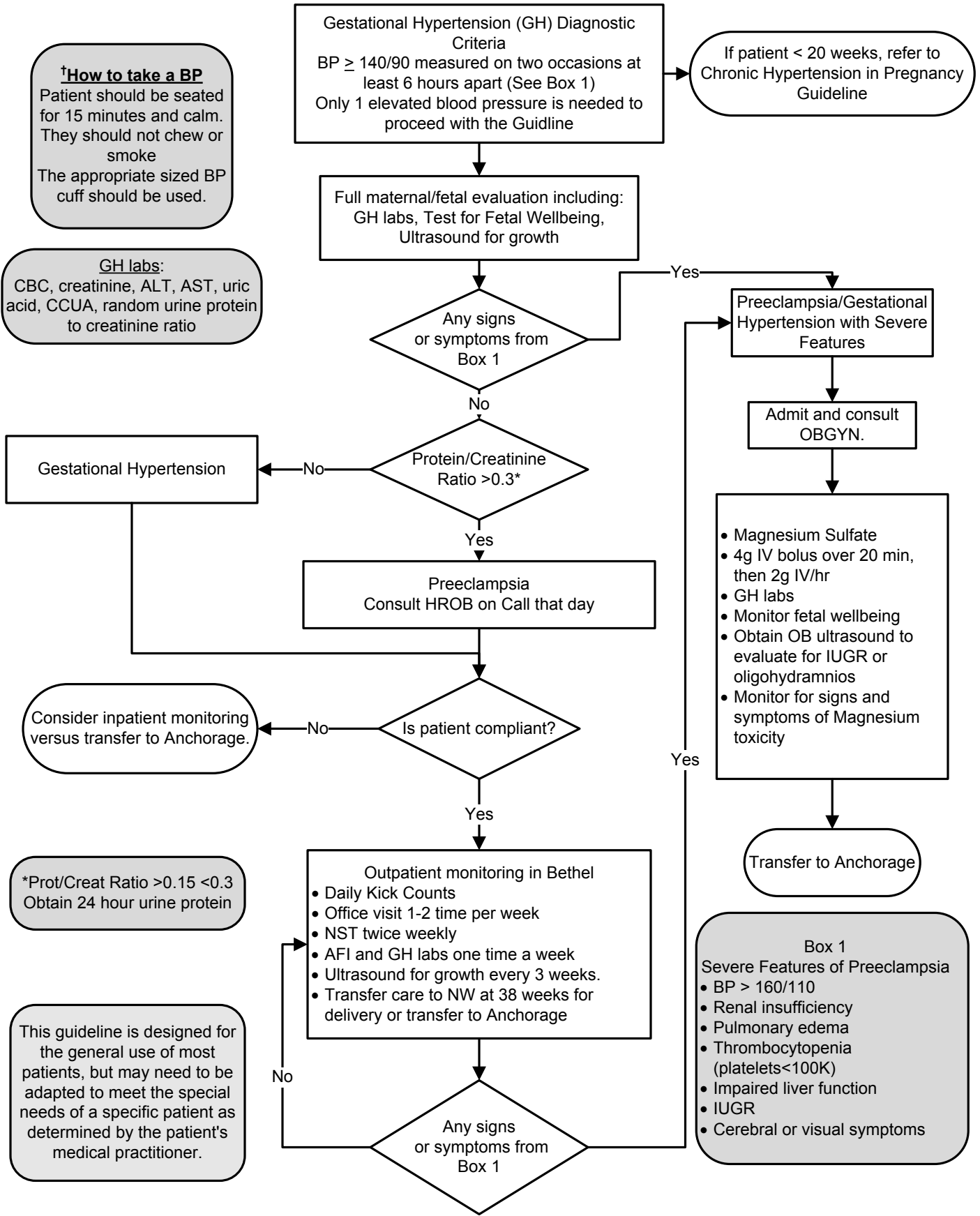

Preterm Premature Rupture of Membranes

rev 07-26-17

Box 1
Signs & Symptoms of ROM

- Pool of fluid in vagina on exam
- Leak of fluid with valsalva
- Positive Ferning test
- Positive Amnisure test
- Oligohydramnios

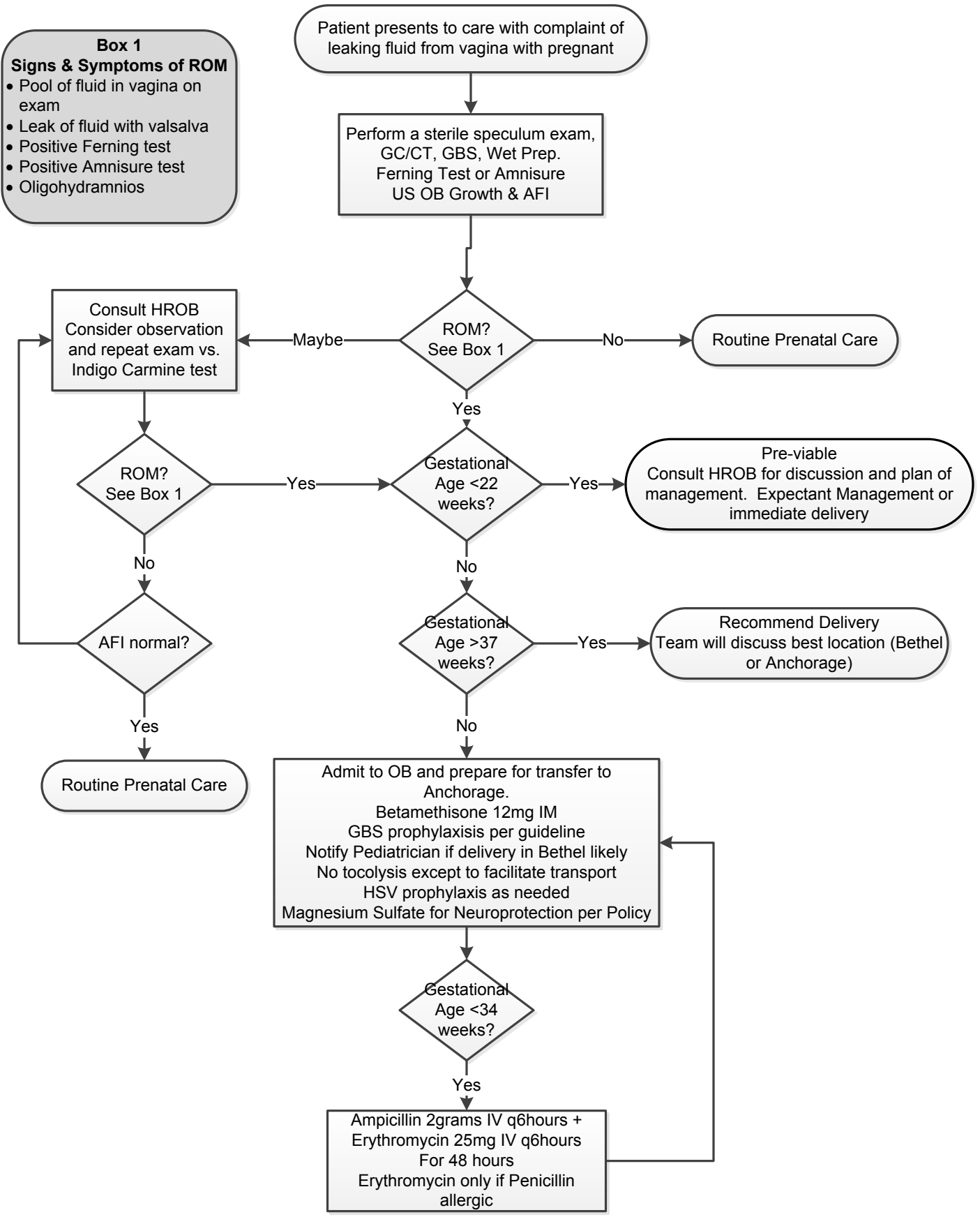

Vaginal Birth After Cesarian

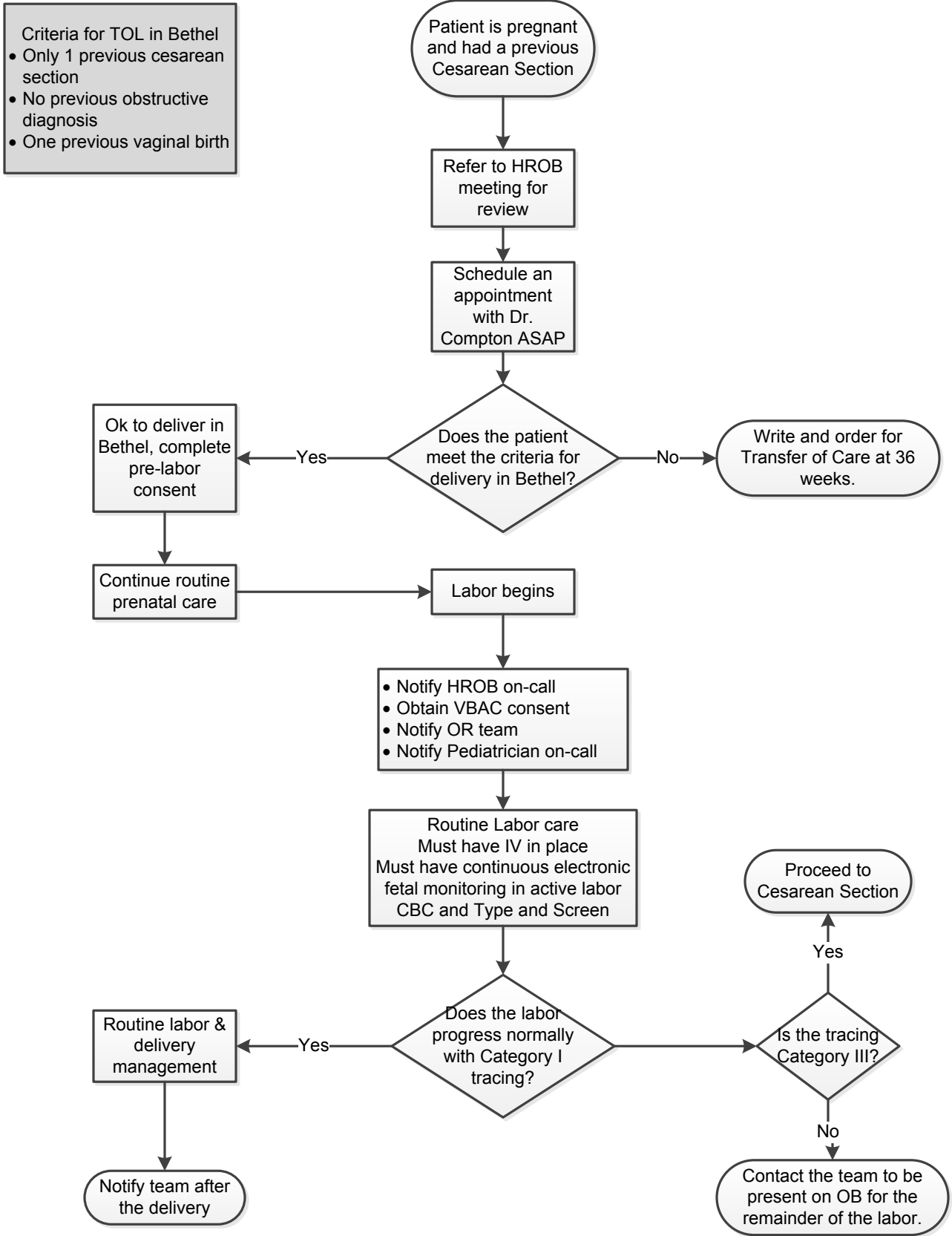

CLINICAL GUIDELINES

2019

rev. 06-27-19

OB Protocols

Antepartum Patient.....	96
Prenatal Care Guidelines	97
Use of Consultants at YKHC	98

Antepartum Patient

MSEC approved 06/22/11

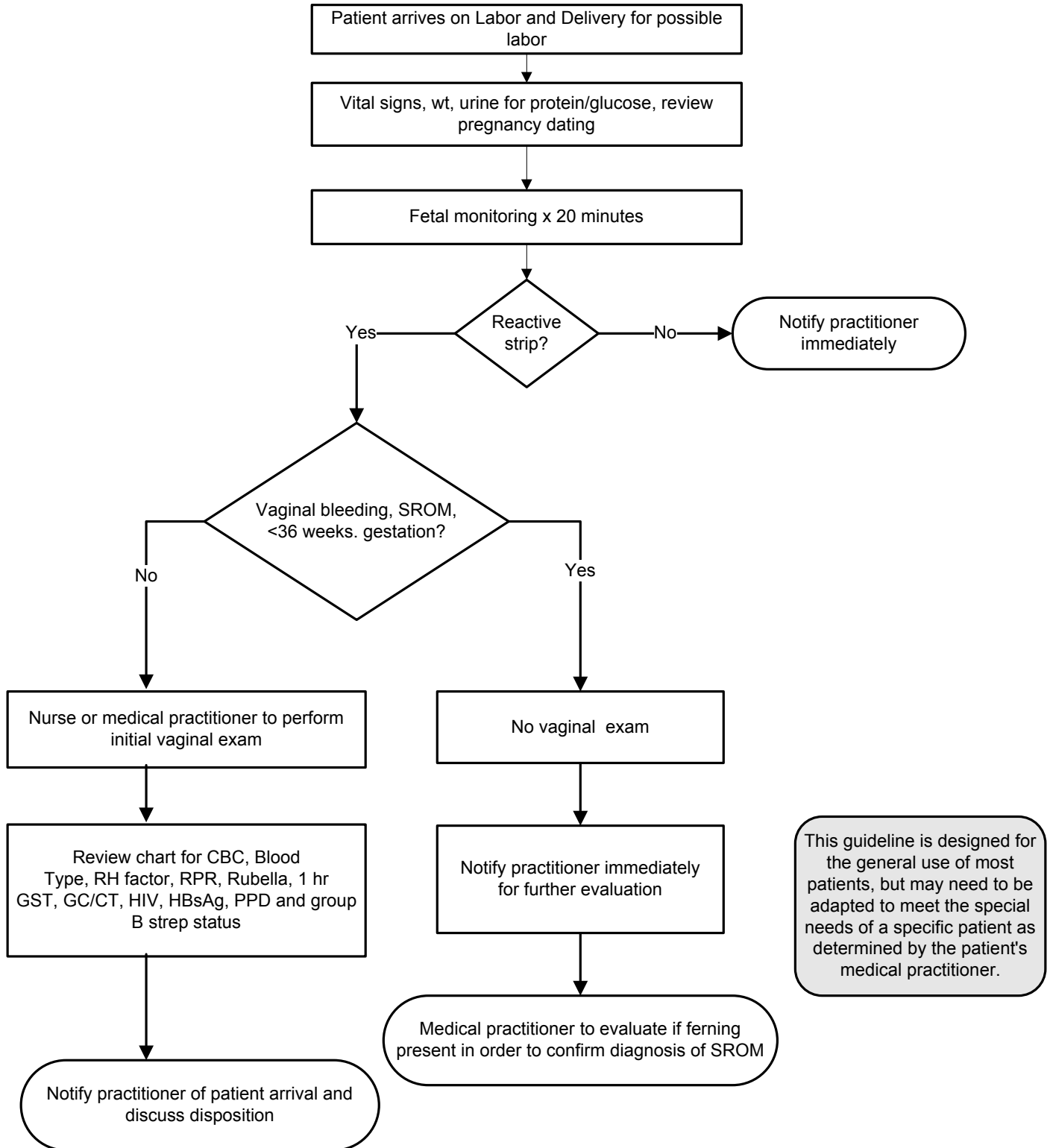

This guideline is designed for the general use of most patients, but may need to be adapted to meet the special needs of a specific patient as determined by the patient's medical practitioner.

Prenatal Care Guidelines

Rev Date: 6/20/17

BASICS

- Review the chart EVERY visit for incomplete lab or other required testing.
- Review the problem list EVERY visit for needed testing or intervention items.
- Patient should see a Bethel provider or CHA/P monthly from first visit to 32 weeks.
- Patient should see a Bethel Provider or CHA/P every 2 weeks after 32 weeks and then weekly at 36 weeks.
- If there is any question of EDC, see guideline or refer to HROB meeting for decision.

First Prenatal

NURSING/CASE MANAGER

- Order First Trimester Transvaginal OB Ultrasound (>6weeks) for dating
- Patient to initiate paperwork
 - Residential Information sheet
 - Pregnancy Verification Sheet—use LMP if no EDC from ultrasound
 - Quad screen consent form
 - FAS & Drug assessment screening questionnaire
 - 36wk BIB/Medevac Policy
- Review TB screening status –Patient MUST HAVE a negative Quantiferon or PPD prior to 36 weeks to stay at Prematernal Home. Place PPD if needed.
- Send patient for labs: Urinalysis with reflex, Blood type and screen, HbsAg, CBC, Rubella titer, RPR, HIV testing, HgA1C, 25-OH Vitamin D.
- Set up room for pelvic to do PAP (only do a PAP if it is due), Wet Prep, GC/CT (with verbal consent)
- Routine patient handouts: WIC handout

PROVIDER

- Prenatal H&P and Prenatal Education
- Chart review
- Offer Flu vaccine October through the end of the flu season
- Discuss and sign BIB/Medevac Policy contract
- Update the Problem List and include EDC and gravida/para in one problem
- Refer to HROB meeting if needed
- Ask about S/S of IHCP, if positive, add Bile acids and LFTs to lab draw

PATIENT

- Go to the Medicaid office to file for Medicaid
- Go to the WIC office to file for WIC

15–21 Weeks

- Quad screen to be drawn, if desired, must be drawn between 15 and 21 weeks gestation
- Review TB status

20 Weeks

- Ultrasound to screen for anomalies, US OB anatomy and cervical length
 - only one is needed no matter where it is done
 - Aim for 20 weeks
 - If anatomy incomplete, order a US OB follow-up for the next visit to complete the anatomy exam

24–28 Weeks

NURSING

- Labs: GST, CBC, 25-OH Vitamin D
- Tdap, after 24 weeks
- GST-50g (1/2 bottle or 5 oz)
 - If result >140mg/dl schedule 3 hour GTT ASAP.
 - If the result > 179, no GTT, refer directly to diabetes education
- Attempt to keep the patient until the results of the GST are back.
- Review TB status. Send to lab for Quantiferon if failed to have PPD read.

PROVIDER

- After 28 weeks ask about preeclampsia symptoms
- After 24 weeks ask about PTL symptoms and IHCP symptoms?
 - Back pain
 - Sudden increase in vaginal discharge
 - Pelvic Pressure
 - Cramps/contractions
- Educate patient on fetal movement count

36-week/ BIB date

- Labs: CBC, RPR, Pelvic exam with GBS culture, GC/CT, wet mount if concerns.
- Review TB status. Send to lab for Quantiferon if status unknown.
- Schedule appointments to be seen each week by Bethel provider through 41 weeks
- Complete Pre-maternal Home/Medical clearance paper
- Ask about any symptoms of:
 - Rupture of membranes
 - Preeclampsia
 - labor
 - itching

Use of Consultants at YKHC

MSEC approved 11/8/17 Updated 3/7/19

Phone Numbers
 ANMC: Consult: *97 or (907) 563-2662
 Transfer: (907) 729-2337
 PICU Cell for urgent consults: (907) 297-8809
 Providence: ED for on-call specialist: (907) 212-3111
 Trauma: (907) 212-2525
 Alaska Regional Hospital Access Center: (844) 880-5522
 VA/JBER: ED: MD consult number (907) 580-5556
 Transfer: (907) 580-6420
 Admissions 24/7 (907) 580-6423
 Operator: (907) 552-1110
 Harborview Seattle (burns): (888) 731-4791

Page the appropriate provider in Anchorage
 1. ANMC for beneficiaries
 2. Providence Hospital or Alaska Regional Hospital for non-beneficiaries
 3. Alaska Regional for prison inmate
 4. VA or JBER (Joint Base Elmendorf/Richardson) for veterans

Once speaking with the appropriate provider be able to:
 1. State your name, title and department (i.e. ER physician, outpatient NP, second year resident, etc)
 2. State purpose of call (i.e. quick question, possible admission, management advice.)
 3. Provide name, MRN, age, DOB. If the patient is pregnant, give gravity and parity and gestational age in initial sentence, if the patient is a child, give the age in the initial sentence.
 4. Be able to use the SBAR method to communicate patient details (see box below)
 5. Ask a **specific question** about management.
 6. Let accepting physicians know whether you think that the patient can travel by commercial flight or will require air medevac
 7. If there is a problem getting an accepting physician for a medevac/transfer or with patient management decisions, see NOTE below

Document consultant advice in the medical record, include date, time, first and last name of consultant and a summary of the advice given

Provider needs consultation about patient at YKHC

Consult provider is located in Bethel?

No

Yes

Patient is critically ill and the consultant is required at bedside?

No

Yes

Page provider STAT to come to bedside and assist in management.

If on-going management is required, a decision must be made **immediately** and **communicated** about who will be the primary managing provider giving orders and documenting in the medical record.

Once patient is stabilized, discussion will occur between the primary provider and the consultant regarding documentation of the patient's medical care in the record and ongoing management.

If you're an SRC provider, you do not have the luxury of paging the provider STAT to bedside, for the purposes of this protocol, the SBAR case presentation and the documentation requirements apply.

Remember: Unless you transfer care of the patient, YOU are responsible for orders, documentation and notifying the patient and family of the plan of care.

Page the appropriate provider. Have ready the following information:
 1. State your name, title and department (i.e. ER physician, outpatient NP, second year resident, etc)
 2. State purpose of call (i.e. quick question, possible admission, management advice.)
 3. Name, MRN, age, DOB. If the patient is pregnant, give gravity and parity and gestational age in initial sentence, if the patient is a child, give the age in the initial sentence.
 4. Be able to use the SBAR method to communicate patient details (see box below)
 5. Ask a **specific question** about management.

Provider requesting consult must document consultant's advice in the medical record. Include date, time, first and last name of consultant and a summary of the advice given

At any time in the process, if the primary provider wants support at the bedside, page the consultant and ask them to come to bedside and provide support

Clear role delineation must occur establishing who is the primary managing provider.

SBAR:
Situation: a concise statement of the problem, a "one-liner"
 "This is a 3 year old otherwise healthy girl with a fever..."
 "My patient is a 20 year old G3P2 at 26 weeks with vaginal bleeding..."
 "I'm taking care of a 21 year old male with fever and abdominal pain..."
Background: pertinent and brief information related to the situation
 "The labs are normal and CXR shows no infiltrate but her pulse is elevated..."
 "I have performed a sterile speculum exam and there is frank blood in the vault..."
 "The patient's CT show appendicitis and the patient is vomiting all intake..."
Assessment: analysis and consideration of options, what you found/think
 "I think she needs a fluid bolus but I am wondering if she also needs a UA..."
 "I think this patient might have an active abruption..."
 "I think this patient has appendicitis and needs to be transferred to ANMC..."
Recommendation: action requested, what you want
 "I want your opinion on how much fluid and the need for a UA..."
 "I want you to come in and asses this patient in person..."
 "I would like to transfer this patient via medevac to ANMC..."

NOTE:
 If there is a disagreement regarding the management of a patient between the consultant and the primary provider, the primary provider will advise the consultant as to the reason for the disagreement. If a consensus cannot be reached, a third opinion shall be obtained. This can either be from a YK based provider or from a provider from another facility. At any time the Clinical Director on call can also be notified.

CLINICAL GUIDELINES

2019

rev. 06-27-19

Outpatient Guidelines

Skin and Soft Tissue Infection	100
Aspirin.....	102
Type 2 Diabetes.....	103
Congestive Heart Failure.....	106
Dyspepsia – H. Pylori	108
Hypertension	109
Myocardial Infarction (AMI) – Post Discharge Care	110
Breast Cancer Screening	111
UTI – Adult.....	112
Latent Tuberculosis Bacterial Infection (LTBI)	113

Skin and Soft Tissue Infection, p.1

MSEC approved 07/12/17

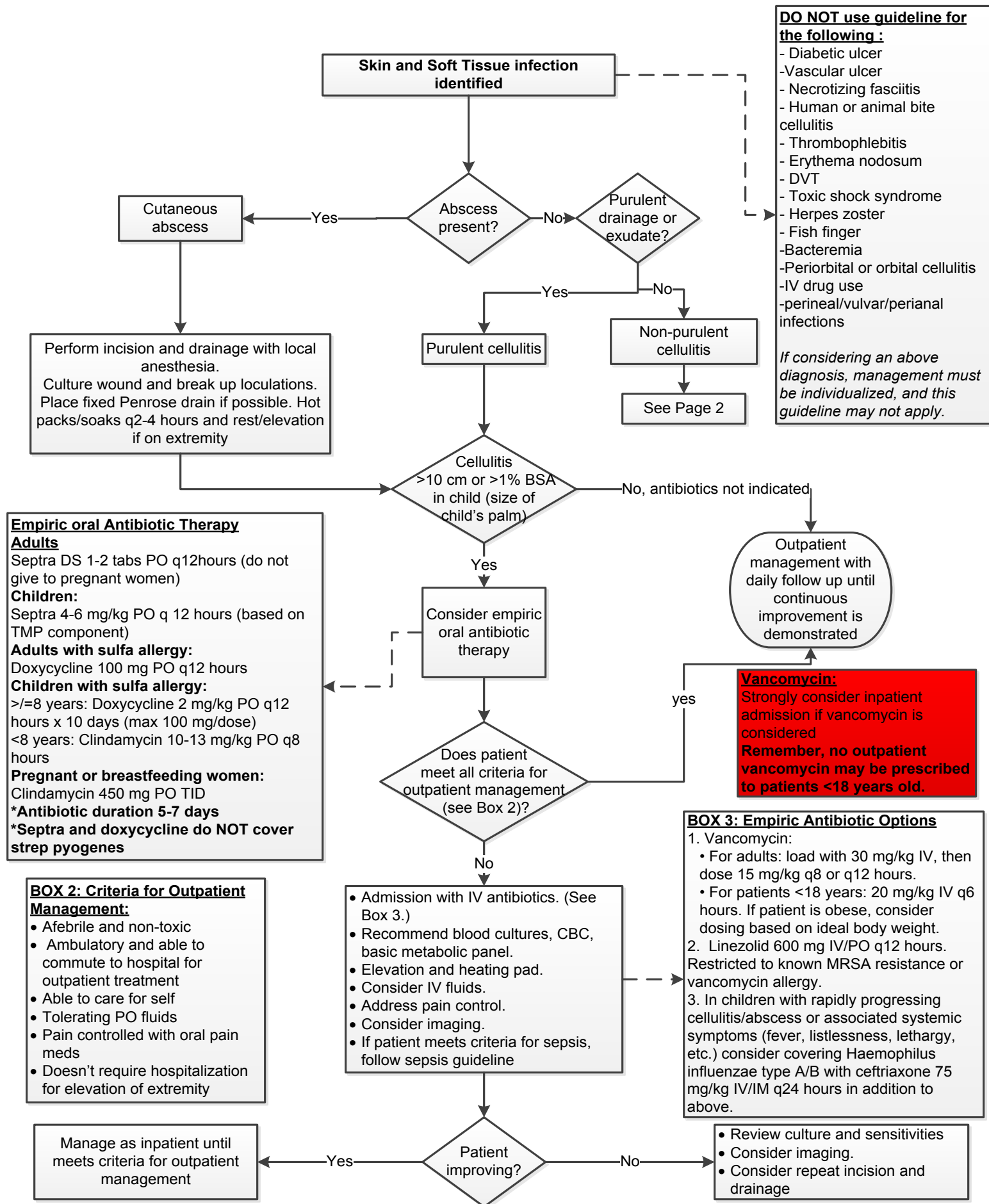

DO NOT use guideline for the following :

- Diabetic ulcer
- Vascular ulcer
- Necrotizing fasciitis
- Human or animal bite cellulitis
- Thrombophlebitis
- Erythema nodosum
- DVT
- Toxic shock syndrome
- Herpes zoster
- Fish finger
- Bacteremia
- Periorbital or orbital cellulitis
- IV drug use
- perineal/vulvar/perianal infections

If considering an above diagnosis, management must be individualized, and this guideline may not apply.

Empiric oral Antibiotic Therapy

Adults
 Septra DS 1-2 tabs PO q12hours (do not give to pregnant women)

Children:
 Septra 4-6 mg/kg PO q 12 hours (based on TMP component)

Adults with sulfa allergy:
 Doxycycline 100 mg PO q12 hours

Children with sulfa allergy:
 >=8 years: Doxycycline 2 mg/kg PO q12 hours x 10 days (max 100 mg/dose)
 <8 years: Clindamycin 10-13 mg/kg PO q8 hours

Pregnant or breastfeeding women:
 Clindamycin 450 mg PO TID

***Antibiotic duration 5-7 days**
***Septra and doxycycline do NOT cover strep pyogenes**

BOX 2: Criteria for Outpatient Management:

- Afebrile and non-toxic
- Ambulatory and able to commute to hospital for outpatient treatment
- Able to care for self
- Tolerating PO fluids
- Pain controlled with oral pain meds
- Doesn't require hospitalization for elevation of extremity

- Admission with IV antibiotics. (See Box 3.)
- Recommend blood cultures, CBC, basic metabolic panel.
- Elevation and heating pad.
- Consider IV fluids.
- Address pain control.
- Consider imaging.
- If patient meets criteria for sepsis, follow sepsis guideline

BOX 3: Empiric Antibiotic Options

1. Vancomycin:
 - For adults: load with 30 mg/kg IV, then dose 15 mg/kg q8 or q12 hours.
 - For patients <18 years: 20 mg/kg IV q6 hours. If patient is obese, consider dosing based on ideal body weight.
2. Linezolid 600 mg IV/PO q12 hours. Restricted to known MRSA resistance or vancomycin allergy.
3. In children with rapidly progressing cellulitis/abscess or associated systemic symptoms (fever, listlessness, lethargy, etc.) consider covering Haemophilus influenzae type A/B with ceftriaxone 75 mg/kg IV/IM q24 hours in addition to above.

Vancomycin:
 Strongly consider inpatient admission if vancomycin is considered
Remember, no outpatient vancomycin may be prescribed to patients <18 years old.

Skin and Soft Tissue Infection, p.2

MSEC approved 07-12-17

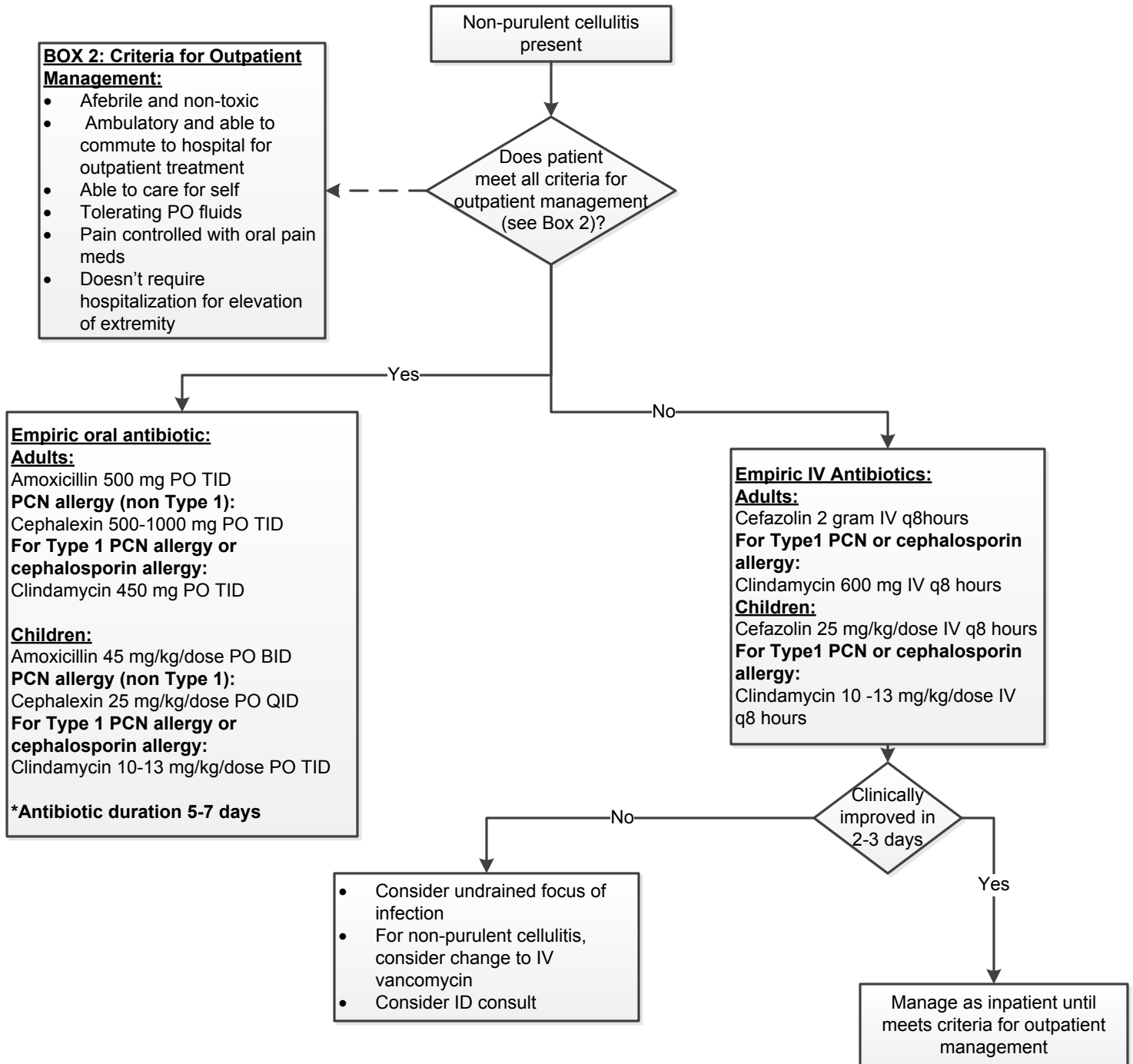

Aspirin

MSEC approved 07-12-17

USPSTF gives the following recommendation a B grade:
Initiation of low dose aspirin for the primary prevention of cardiovascular disease (CVD) and colorectal cancer (CRC) in adults aged 50-59 years who have a 10% or greater 10 yr CVD risk, are not at increased risk for bleeding, have a life expectancy of at least 10 years, and are willing to take low-dose aspirin daily for at least 10 years.

USPSTF gives the following recommendation a C grade:
The decision to initiate low-dose aspirin use for the primary prevention of CVD and CRC in adults age 60-69 years who have a 10% or greater 10 year CVD risk should be an individual one. Persons who are not at increased risk for bleeding, have a life expectancy of at least 10 years, and are willing to take low-dose aspirin for at least 10 years are most likely to benefit. Persons who place a higher value on the potential benefits than the potential harms may choose to initiate low-dose aspirin.

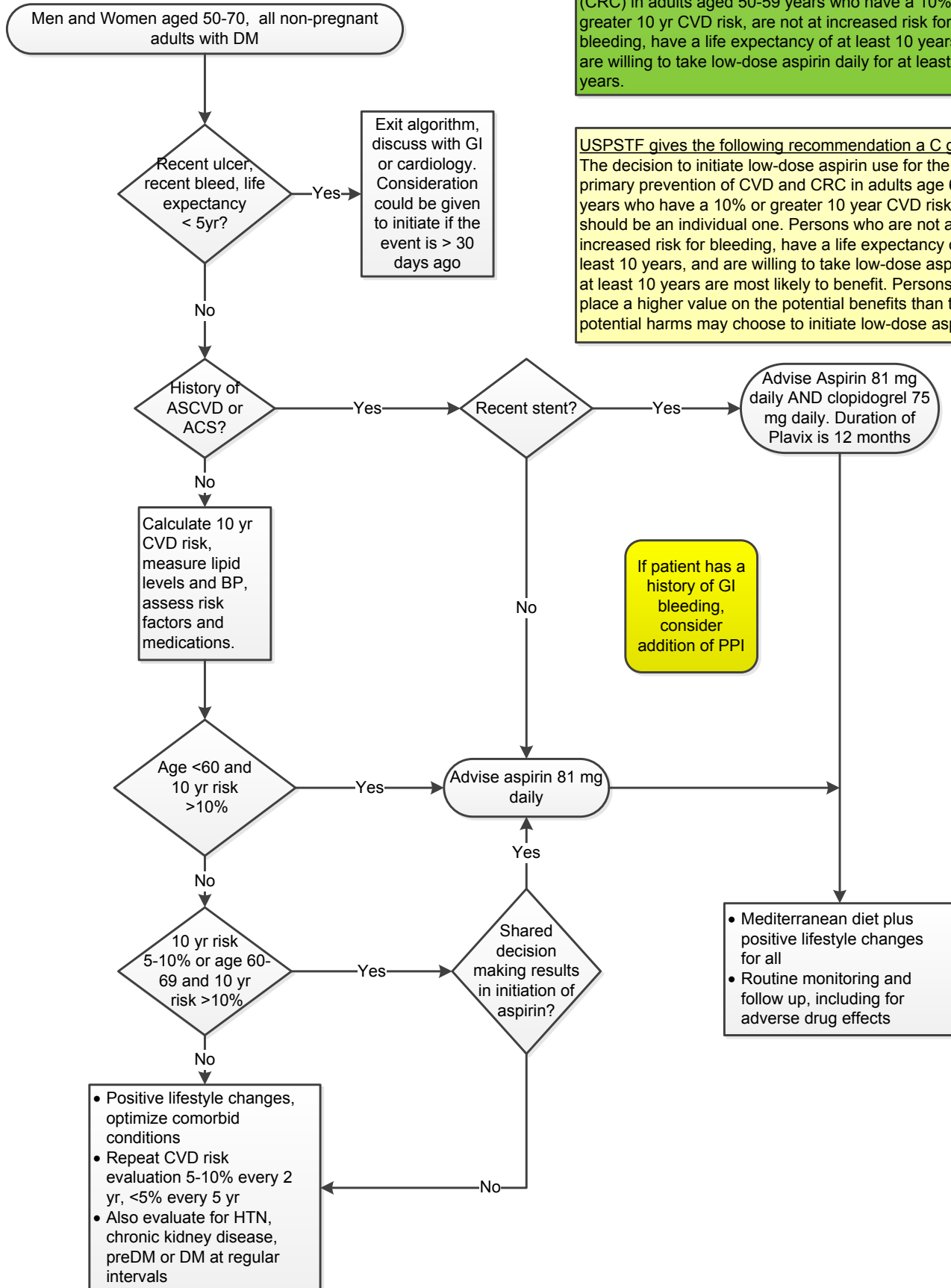

Type 2 Diabetes

MSEC approved March, 2015

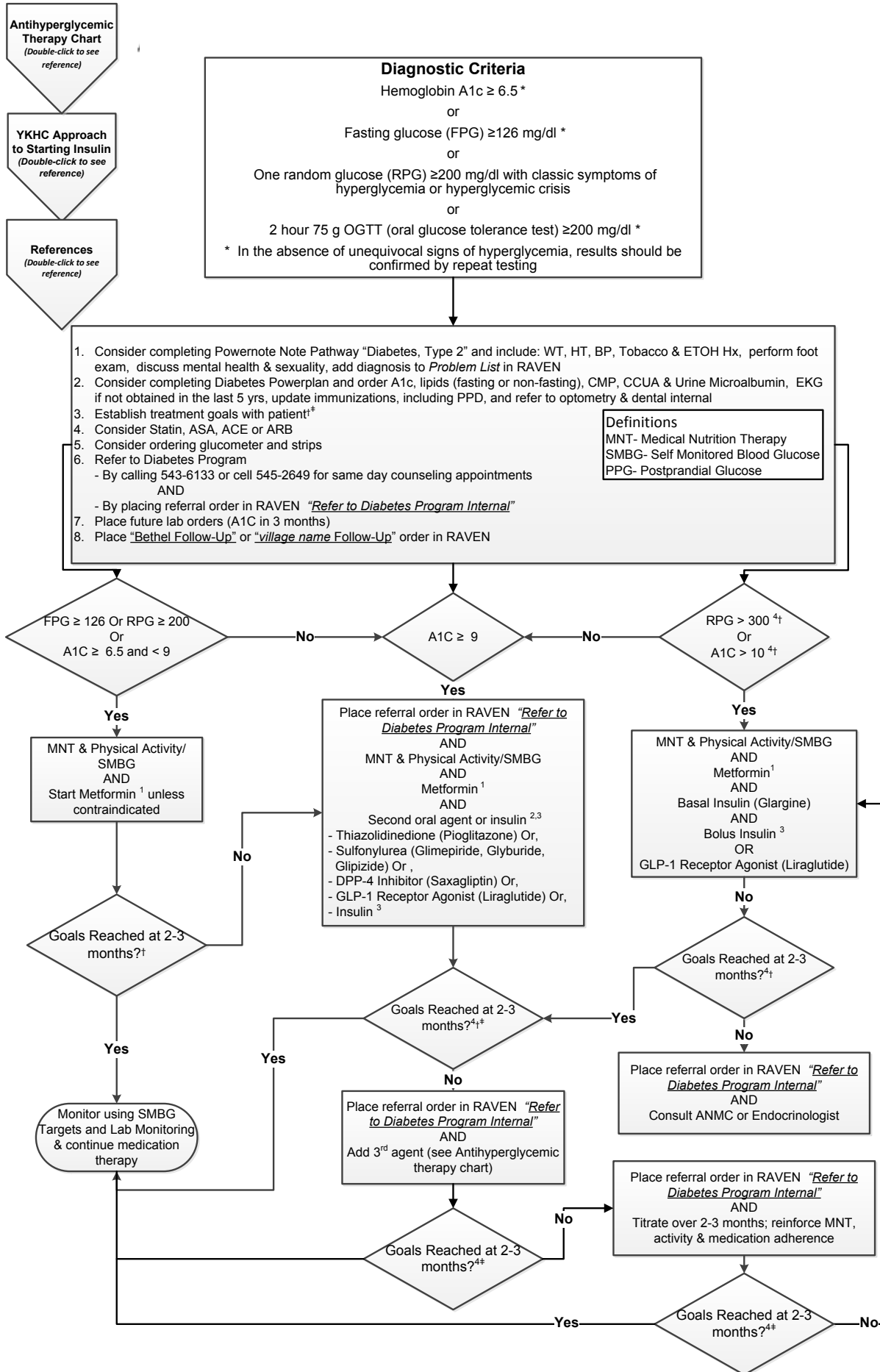

1

Type 2 Diabetes

MSEC approved March, 2015

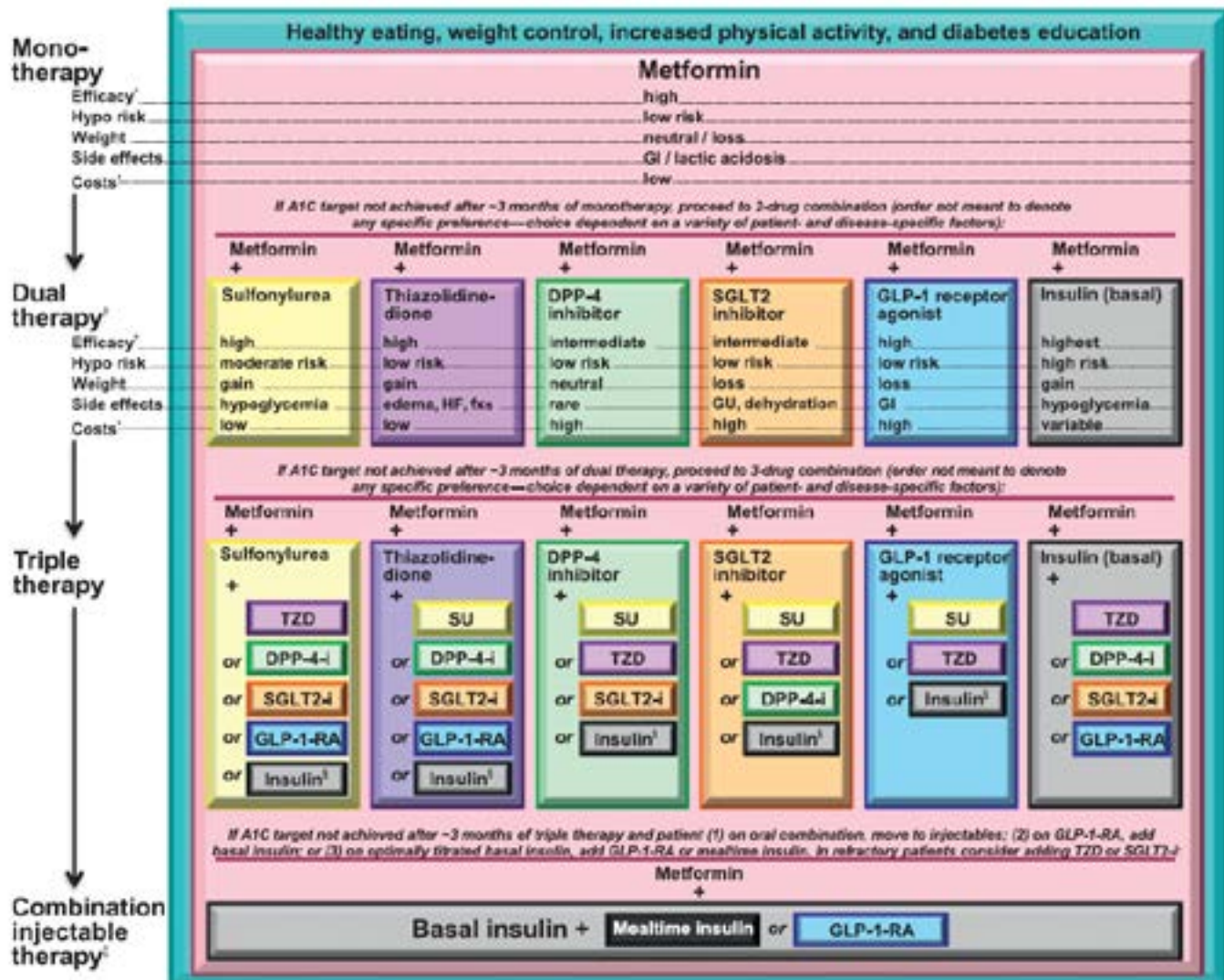

References

1. ADA 2014 Guidelines; Metformin: Preferred initial therapy (if tolerated and not contraindicated)
 2. ADA 2014 Guidelines; Add second oral agent, GLP-1 receptor agonist, or insulin If non-insulin monotherapy at maximum tolerated dose does not achieve or maintain A1c target over 3 mos.
 3. ADA 2014 Guidelines; Consider insulin therapy with or without other agents at outset in newly diagnosed patients with markedly symptomatic and/or elevated BG levels or A1C
 4. ADA 2015 Standards of Care; Summary of glycemic recommendations for nonpregnant adults with diabetes
- † More or less stringent glycemic controls may be appropriate for individual patients. Goals should be individualized based on duration of diabetes, age/life expectancy co-morbid conditions, known CVD or advanced microvascular complications, hypoglycemia unawareness, and individual patient considerations. (See Glycemic Targets Chart on the Document Library)
- ‡ Postprandial glucose may be targeted if A1c goals are not met despite reaching preprandial glucose goals.

Type 2 Diabetes

MSEC approved March, 2015

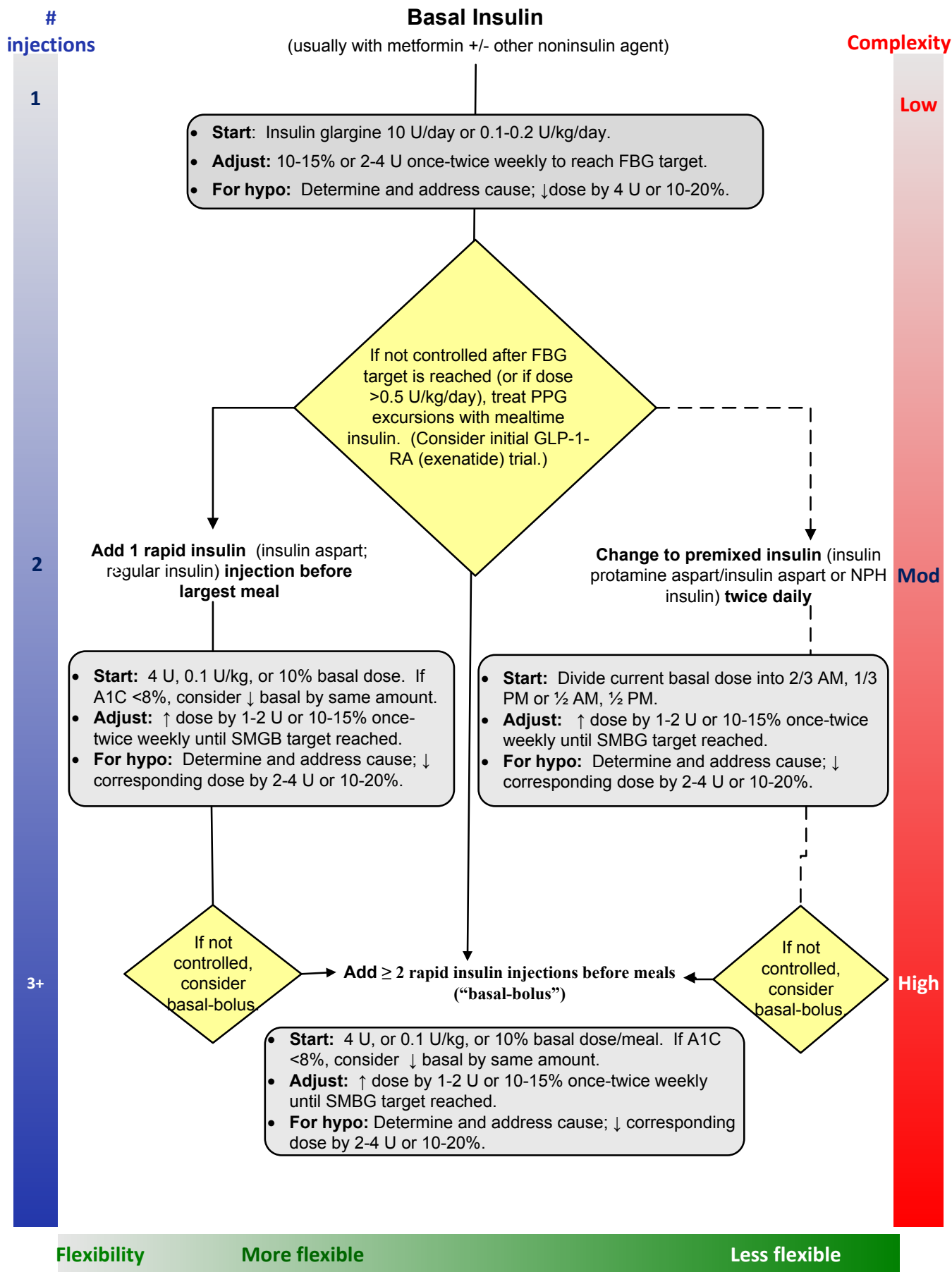

Congestive Heart Failure, p.1

MSEC approved 07-12-17

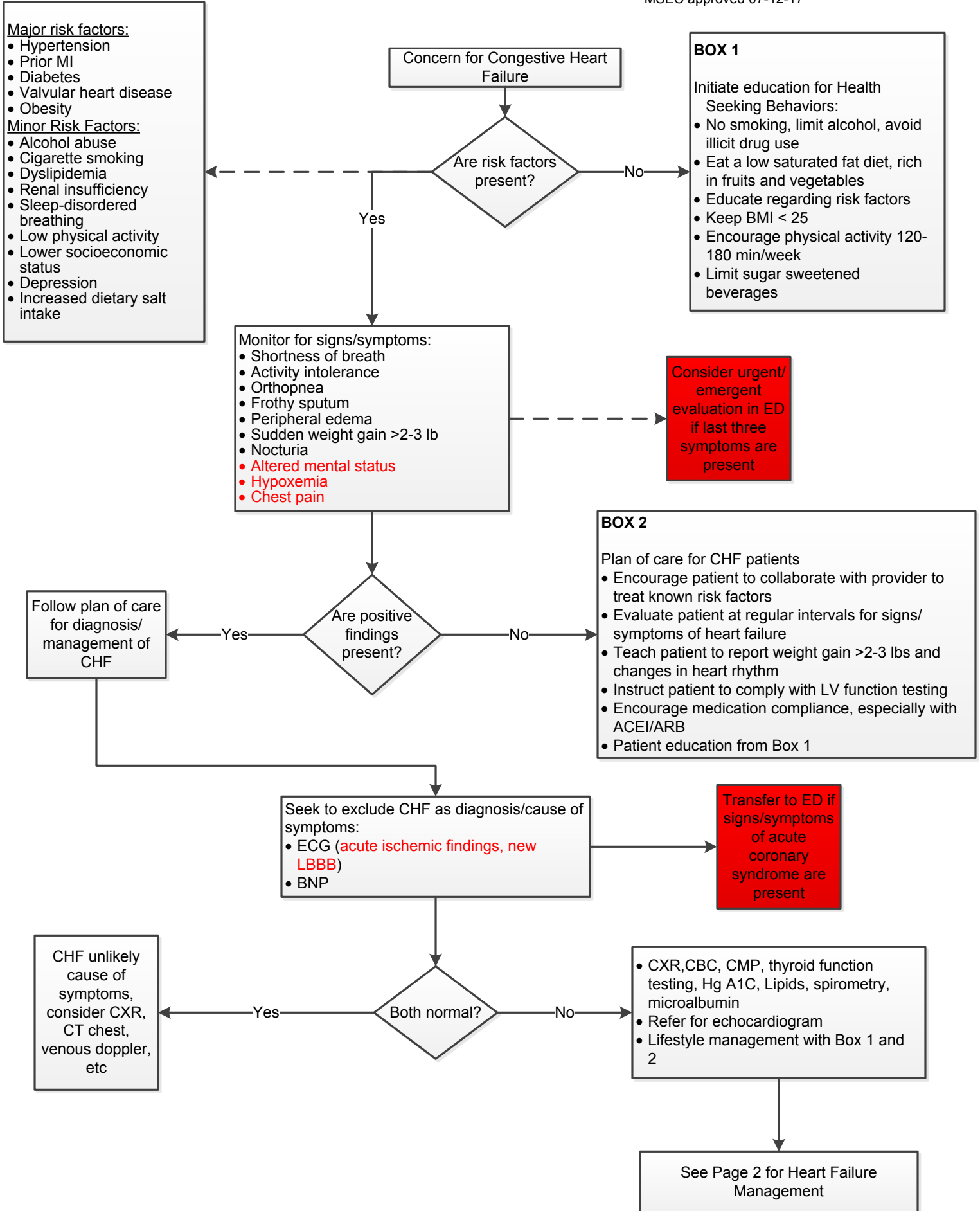

Congestive Heart Failure, p.2

MSEC approved 07-12-17

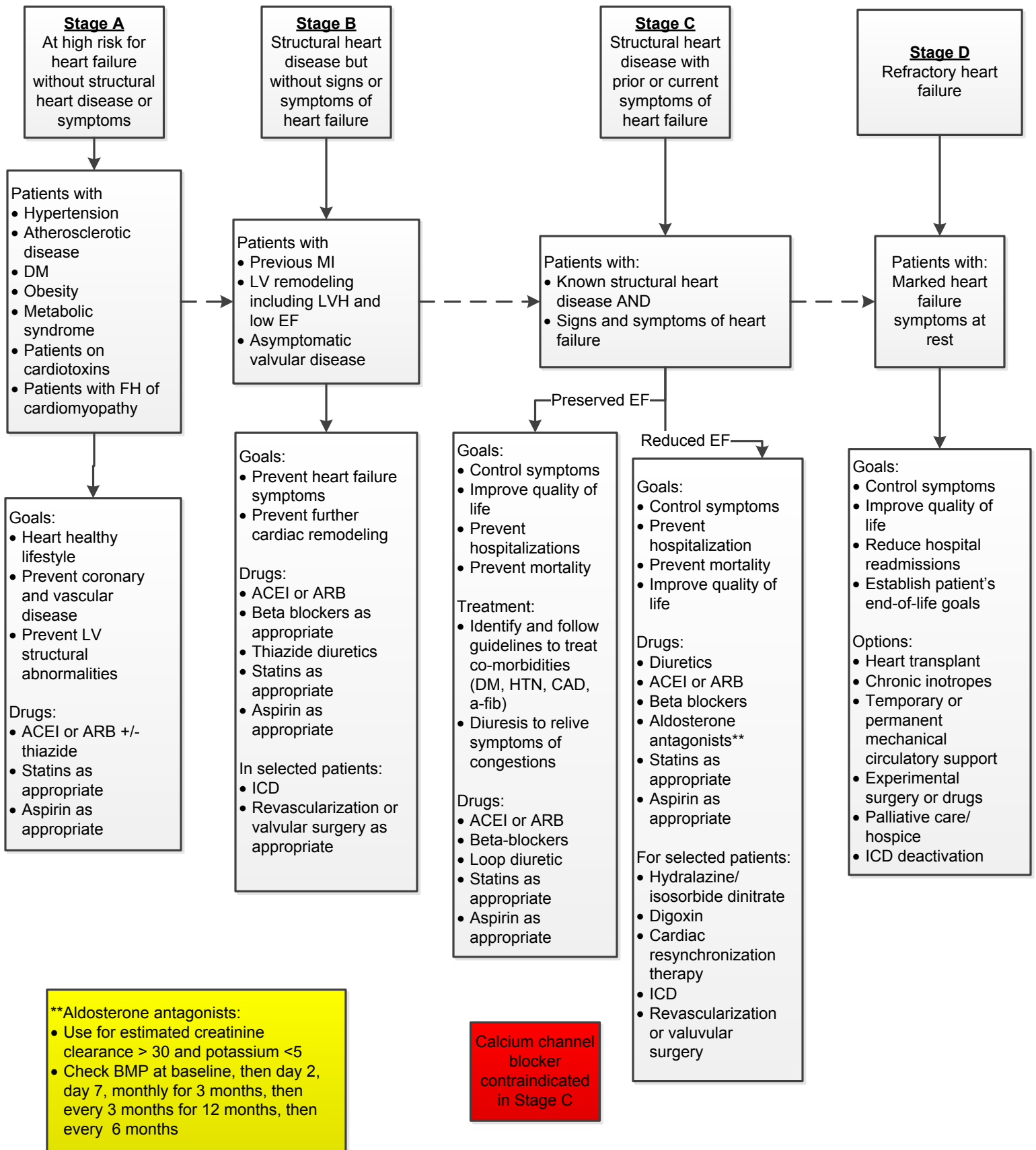

Dyspepsia – H. Pylori

MSEC approved 4/26/18

Background Information:

- 75% of the AN/AI population is colonized with H. Pylori (range 61-84%).
- Screening or testing for H. Pylori for routine evaluation of dyspepsia or other GI symptoms is not clinically useful or supported by evidence for high prevalence populations.
- For routine clinical practice, there is **insufficient evidence-based data** to support community-wide eradication as a mechanism for gastric cancer prevention.
- Current literature **DO NOT** support a test and treat method with noninvasive tests.

Pediatrics:

- Goal is to determine underlying cause of symptoms, not solely the presence of H pylori infection.
- Principles of testing and treatment are the same as for adults.
- Diagnostic testing is NOT recommended with functional abdominal pain or iron-deficiency anemia.
- Consult pediatrics if considering this diagnosis.

Pregnancy and Lactation:

- Delay treatment until after pregnancy
- DO NOT use in Pregnancy: bismuth and tetracycline
- DO NOT use in lactation: bismuth, metronidazole, levofloxacin

H. Pylori identified by histology and/or CLO test from EGD

AND
Endoscopy reveals the following:

- Duodenal ulcers
- Gastric ulcer
- MALT lymphoma
- Intestinal metaplasia

Treat for H. Pylori with antibiotics

****All treatment is for 14 days****

Adult Dosing

Preferred Treatment:

- Metronidazole 500 mg PO QID
- Amoxicillin 1000 mg PO BID
- Omeprazole 20 mg PO BID
- Bismuth subsalicylate 524 mg PO QID

PCN allergic (anaphylactic):

- Metronidazole 500 mg PO QID
- Doxycycline 100 mg PO BID
- Omeprazole 20 mg PO BID
- Bismuth subsalicylate 524 mg PO QID

Recurrence/Failure:

- Metronidazole 500 mg PO QID
- Doxycycline 100 mg PO BID
- Omeprazole 20 mg PO BID
- Bismuth subsalicylate 524 mg PO QID
- OR
- Amoxicillin 1000 mg PO BID
- Levofloxacin 500 mg PO daily (FDA Black Box)
- Omeprazole 20 mg PO BID

Pediatric Dosing

- Metronidazole 10 mg/kg PO BID
- Amoxicillin 45 mg/kg PO BID
- Omeprazole 1 mg/kg PO BID
- Bismuth subsalicylate
- <10 years: 262 mg PO QID
- >10 years: 524 mg PO QID

Eradication Testing:

- Urea Breath Test for *Test of Cure* is necessary to determine need for retreatment. It can be performed on children as young as 3. The stool antigen test available at YKHC is not recommended for test of cure.
- 10-35% of individuals will fail treatment.
- Serologic testing is not recommended due to prolonged antibody persistence beyond date of cure and false positive results.
- Must be off PPI for ≥ 2 weeks prior to Urea Breath Test.

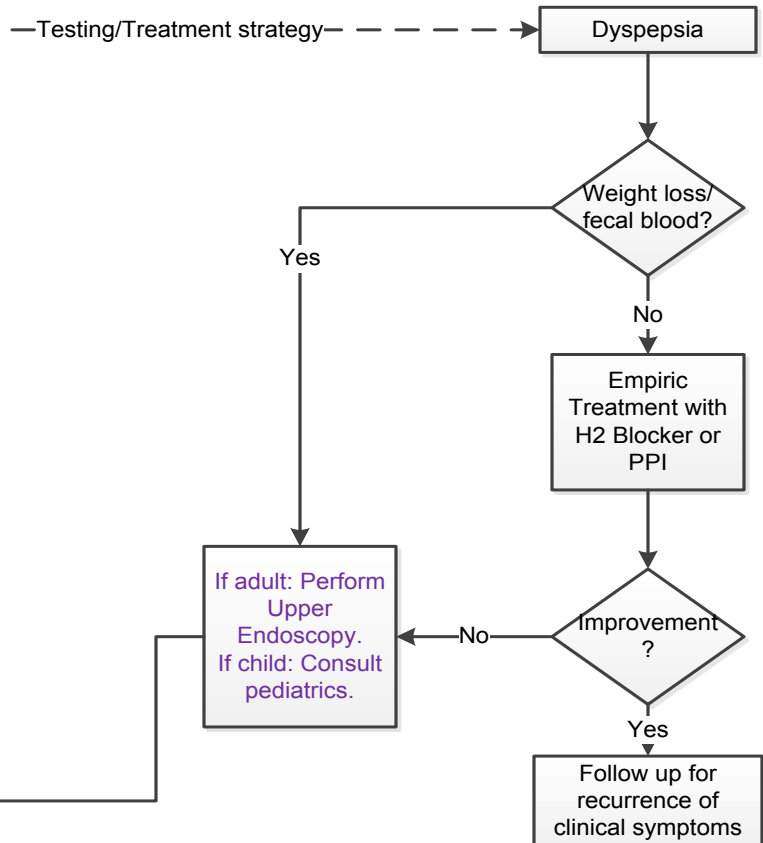

Other causes of dyspepsia that antibiotics will NOT help, **EVEN IF** H. Pylori is detected:

- GERD
- Irritable Bowel Syndrome
- Mild/moderate gastritis
- Excessive/chronic NSAID use
- Heavy alcohol use
- Poor gastric mobility

Symptomatic relief Medications:

- Adults:
Ranitidine 150 mg PO BID
Omeprazole 20 mg PO BID
- Children:
Ranitidine 5-10 mg/kg PO divided BID

Hypertension

MSEC approved 06/17

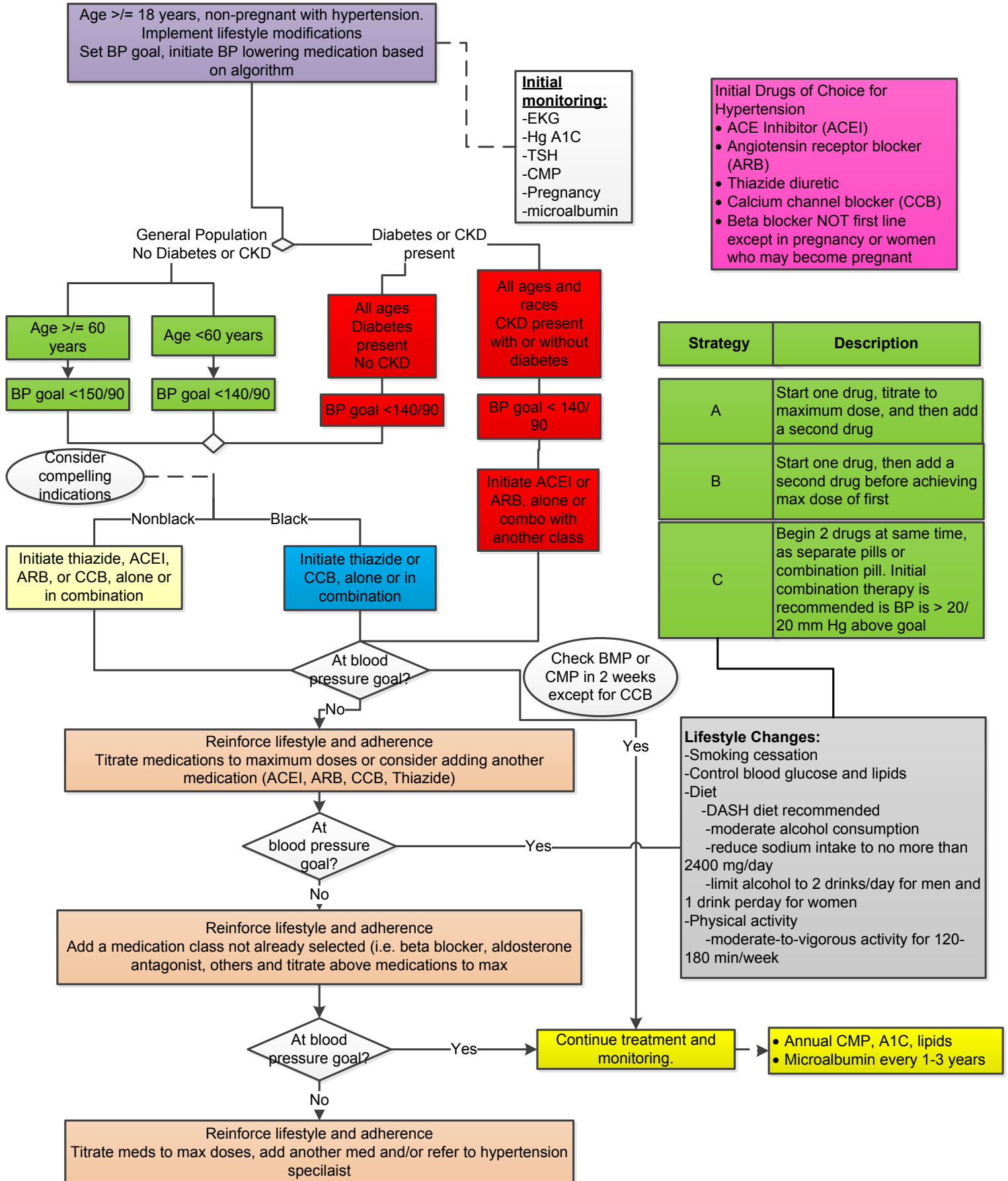

Myocardial Infarction (AMI) – Post Discharge Care

MSEC approved 06/22/11

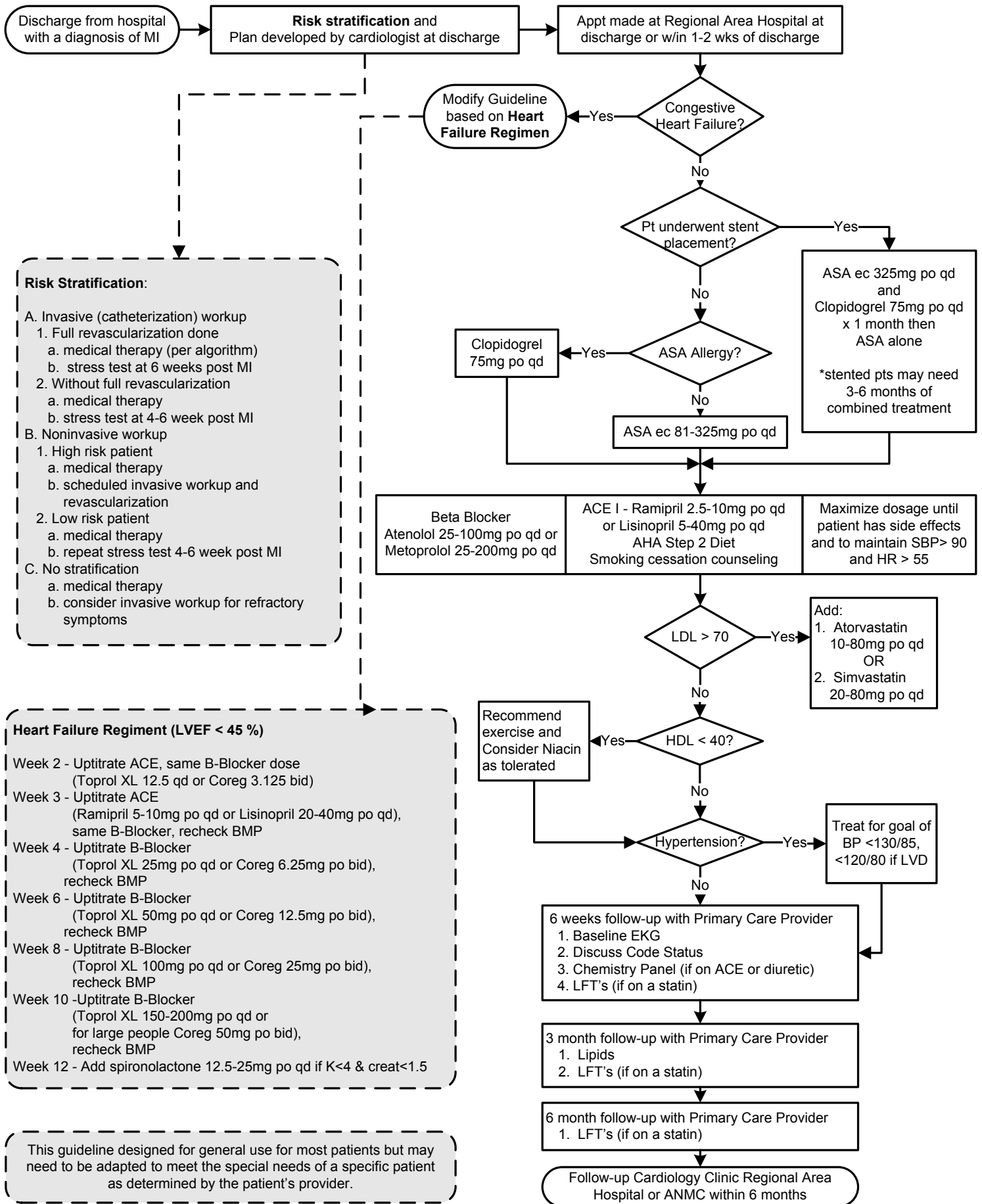

Breast Cancer Screening

MSEC approved 06/22/11

Clinical Breast Exam Screening Recommendations:
 1. Breast self-examination: at provider's discretion
 2. Clinical breast examination: at provider's discretion
 3. Mammography: start age 45
 screen every 2 years
 end screening at age 70, based on health status

This guideline is designed for the general use of most patients, but may need to be adapted to meet the special needs of a specific patient as determined by the patient's medical practitioner.

Involve case management to expedite care

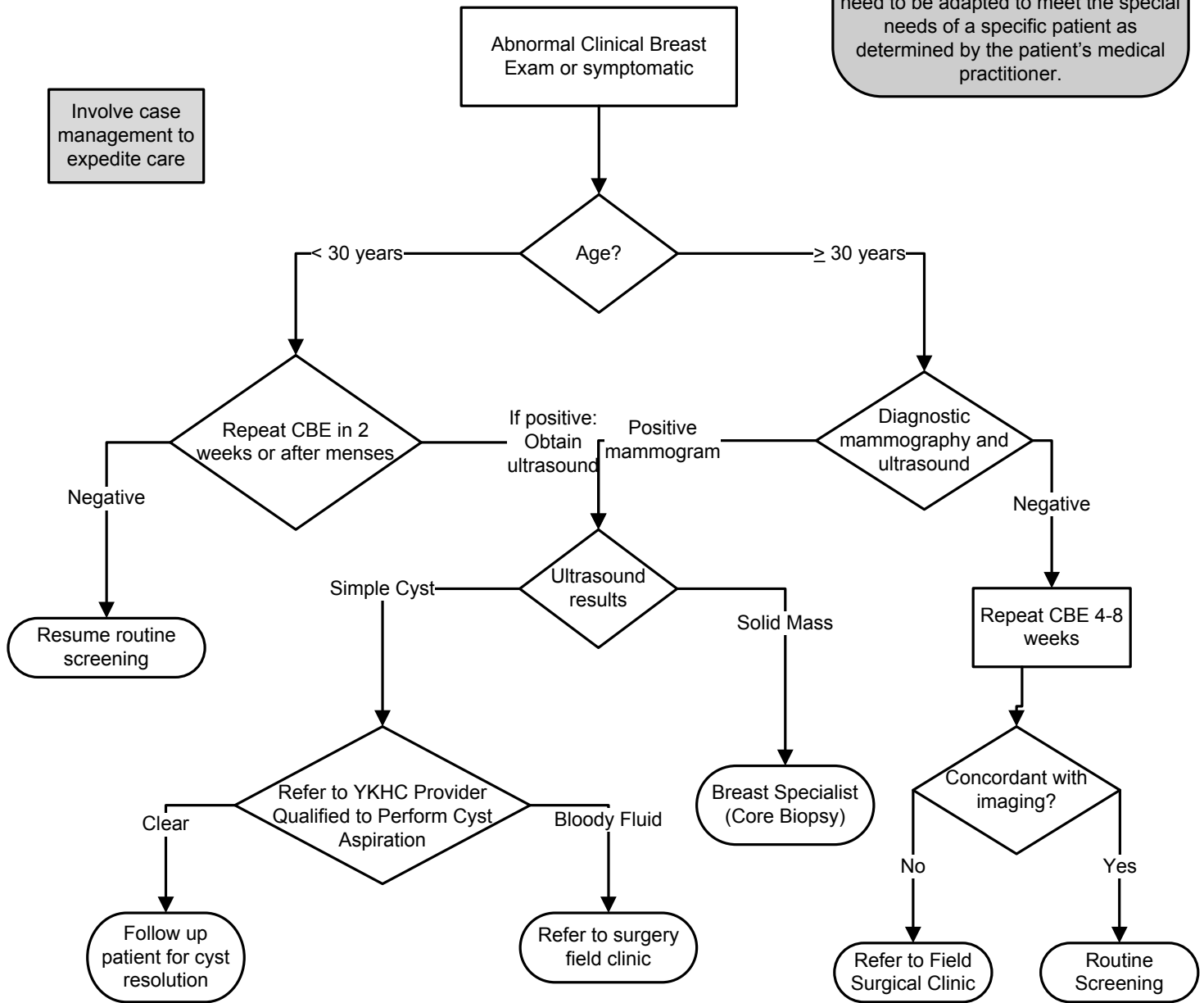

UTI – Adult

MSEC approved 10/15/18

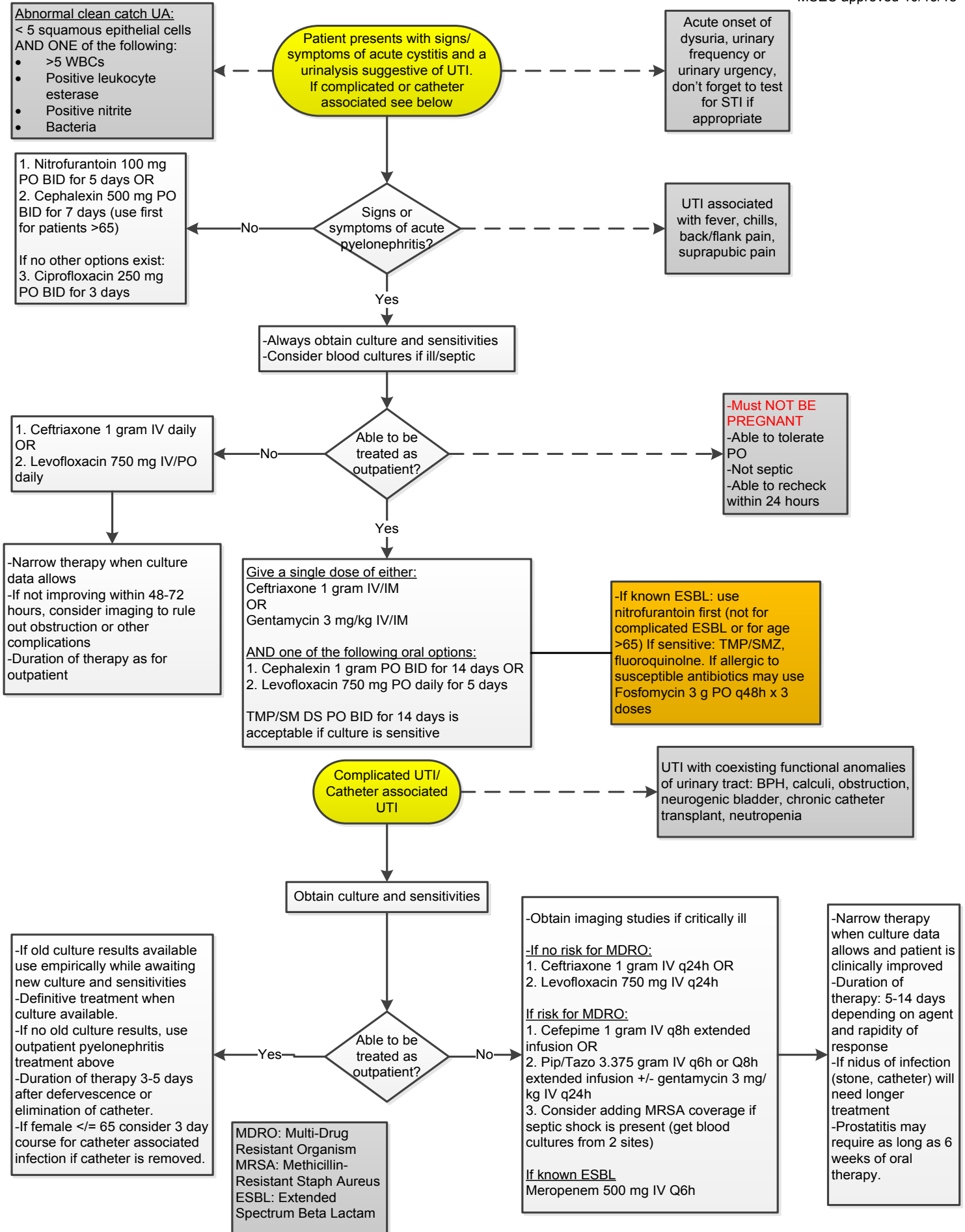

Latent Tuberculosis Bacterial Infection (LTBI)

MSEC Approved 4/19/12

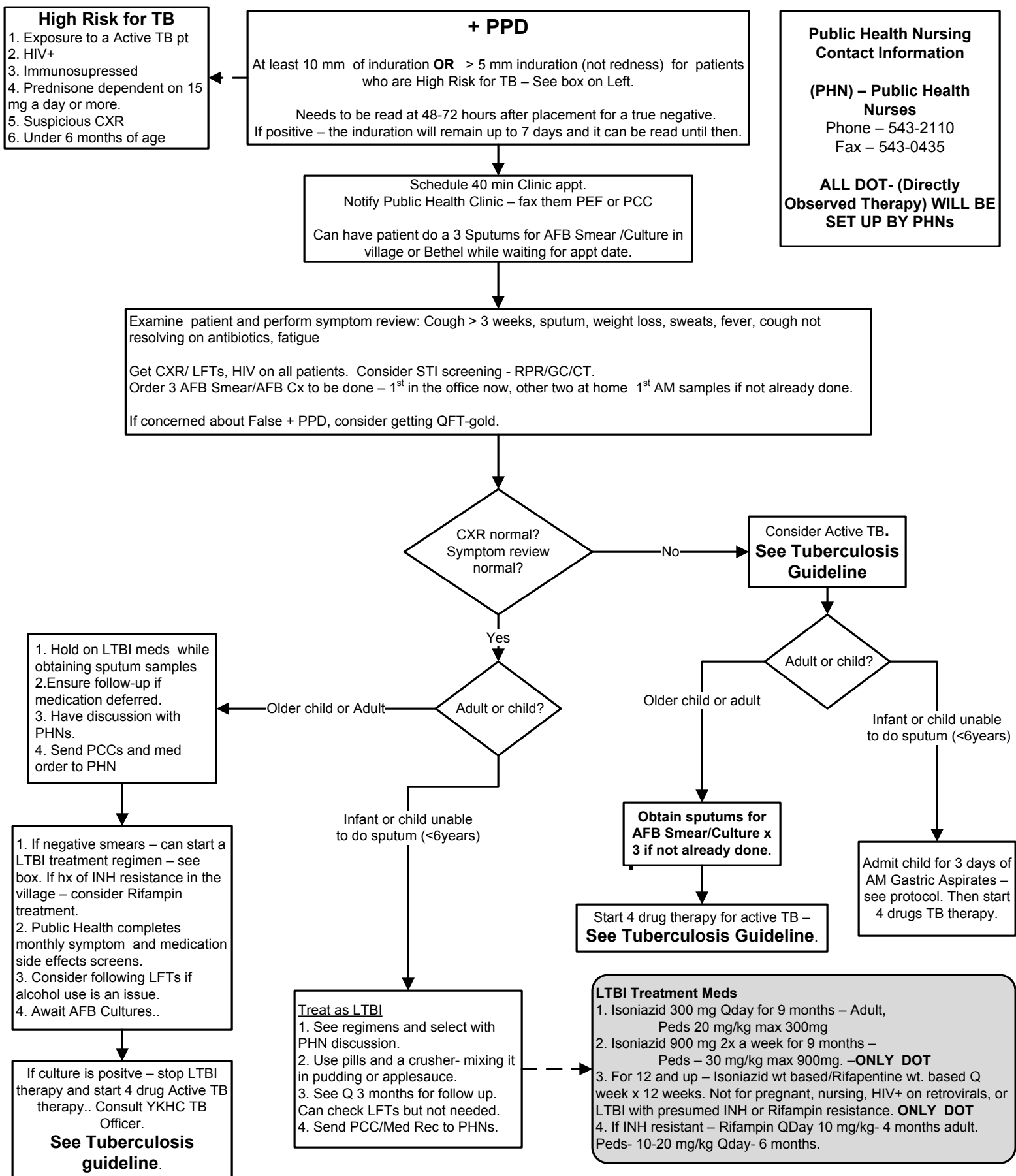

High Risk for TB

1. Exposure to a Active TB pt
2. HIV+
3. Immunosupressed
4. Prednisone dependent on 15 mg a day or more.
5. Suspicious CXR
6. Under 6 months of age

+ PPD

At least 10 mm of induration **OR** > 5 mm induration (not redness) for patients who are High Risk for TB - See box on Left.

Needs to be read at 48-72 hours after placement for a true negative. If positive - the induration will remain up to 7 days and it can be read until then.

Public Health Nursing Contact Information

(PHN) - Public Health Nurses

Phone - 543-2110
Fax - 543-0435

ALL DOT- (Directly Observed Therapy) WILL BE SET UP BY PHNs

Schedule 40 min Clinic appt.
Notify Public Health Clinic - fax them PEF or PCC

Can have patient do a 3 Sputums for AFB Smear /Culture in village or Bethel while waiting for appt date.

Examine patient and perform symptom review: Cough > 3 weeks, sputum, weight loss, sweats, fever, cough not resolving on antibiotics, fatigue

Get CXR/ LFTs, HIV on all patients. Consider STI screening - RPR/GC/CT.
Order 3 AFB Smear/AFB Cx to be done - 1st in the office now, other two at home 1st AM samples if not already done.

If concerned about False + PPD, consider getting QFT-gold.

CXR normal?
Symptom review normal?

Consider Active TB.
See Tuberculosis Guideline

Adult or child?

Adult or child?

1. Hold on LTBI meds while obtaining sputum samples
2. Ensure follow-up if medication deferred.
3. Have discussion with PHNs.
4. Send PCCs and med order to PHN

Obtain sputums for AFB Smear/Culture x 3 if not already done.

Admit child for 3 days of AM Gastric Aspirates - see protocol. Then start 4 drugs TB therapy.

Start 4 drug therapy for active TB - See Tuberculosis Guideline.

1. If negative smears - can start a LTBI treatment regimen - see box. If hx of INH resistance in the village - consider Rifampin treatment.
2. Public Health completes monthly symptom and medication side effects screens.
3. Consider following LFTs if alcohol use is an issue.
4. Await AFB Cultures..

Treat as LTBI

1. See regimens and select with PHN discussion.
2. Use pills and a crusher- mixing it in pudding or applesauce.
3. See Q 3 months for follow up. Can check LFTs but not needed.
4. Send PCC/Med Rec to PHNs.

LTBI Treatment Meds

1. Isoniazid 300 mg Qday for 9 months - Adult, Peds 20 mg/kg max 300mg
2. Isoniazid 900 mg 2x a week for 9 months - Peds - 30 mg/kg max 900mg. -**ONLY DOT**
3. For 12 and up - Isoniazid wt based/Rifampentine wt. based Q week x 12 weeks. Not for pregnant, nursing, HIV+ on retrovirals, or LTBI with presumed INH or Rifampin resistance. **ONLY DOT**
4. If INH resistant - Rifampin QDay 10 mg/kg- 4 months adult. Peds- 10-20 mg/kg Qday- 6 months.

If culture is positive - stop LTBI therapy and start 4 drug Active TB therapy.. Consult YKHC TB Officer.
See Tuberculosis guideline.

CLINICAL GUIDELINES

2019

rev. 06-27-19

Outpatient Protocols

Use of Consultants at YKHC	115
Colon Cancer Screening	116
Contraception – Quick Start	117
Chronic Pain – Narcotic Treatment Eligibility.....	118
Chronic Pain – Non Narcotics Treatment	119
Chronic Pain – Reassessment & Follow-Up.....	123
Cervical Cancer Screening Protocol.....	124
Pre-Anesthesia Testing.....	125

Use of Consultants at YKHC

MSEC approved 11/8/17 Updated 3/7/19

Phone Numbers
 ANMC: Consult: *97 or (907) 563-2662
 Transfer: (907) 729-2337
 PICU Cell for urgent consults: (907) 297-8809
 Providence: ED for on-call specialist: (907) 212-3111
 Trauma: (907) 212-2525
 Alaska Regional Hospital Access Center: (844) 880-5522
 VA/JBER: ED: MD consult number (907) 580-5556
 Transfer: (907) 580-6420
 Admissions 24/7 (907) 580-6423
 Operator: (907) 552-1110
 Harborview Seattle (burns): (888) 731-4791

Page the appropriate provider in Anchorage
 1. ANMC for beneficiaries
 2. Providence Hospital or Alaska Regional Hospital for non-beneficiaries
 3. Alaska Regional for prison inmate
 4. VA or JBER (Joint Base Elmendorf/Richardson) for veterans

Once speaking with the appropriate provider be able to:
 1. State your name, title and department (i.e. ER physician, outpatient NP, second year resident, etc)
 2. State purpose of call (i.e. quick question, possible admission, management advice.)
 3. Provide name, MRN, age, DOB. If the patient is pregnant, give gravity and parity and gestational age in initial sentence, if the patient is a child, give the age in the initial sentence.
 4. Be able to use the SBAR method to communicate patient details (see box below)
 5. Ask a **specific question** about management.
 6. Let accepting physicians know whether you think that the patient can travel by commercial flight or will require air medevac
 7. If there is a problem getting an accepting physician for a medevac/transfer or with patient management decisions, see NOTE below

Document consultant advice in the medical record, include date, time, first and last name of consultant and a summary of the advice given

Provider needs consultation about patient at YKHC

Consult provider is located in Bethel?

No

Yes

Patient is critically ill and the consultant is required at bedside?

No

Yes

Page provider STAT to come to bedside and assist in management.

If on-going management is required, a decision must be made **immediately** and **communicated** about who will be the primary managing provider giving orders and documenting in the medical record.

Once patient is stabilized, discussion will occur between the primary provider and the consultant regarding documentation of the patient's medical care in the record and ongoing management.

If you're an SRC provider, you do not have the luxury of paging the provider STAT to bedside, for the purposes of this protocol, the SBAR case presentation and the documentation requirements apply.

Remember: Unless you transfer care of the patient, YOU are responsible for orders, documentation and notifying the patient and family of the plan of care.

Page the appropriate provider. Have ready the following information:
 1. State your name, title and department (i.e. ER physician, outpatient NP, second year resident, etc)
 2. State purpose of call (i.e. quick question, possible admission, management advice.)
 3. Name, MRN, age, DOB. If the patient is pregnant, give gravity and parity and gestational age in initial sentence, if the patient is a child, give the age in the initial sentence.
 4. Be able to use the SBAR method to communicate patient details (see box below)
 5. Ask a **specific question** about management.

Provider requesting consult must document consultant's advice in the medical record. Include date, time, first and last name of consultant and a summary of the advice given

At any time in the process, if the primary provider wants support at the bedside, page the consultant and ask them to come to bedside and provide support

Clear role delineation must occur establishing who is the primary managing provider.

SBAR:
Situation: a concise statement of the problem, a "one-liner"
 "This is a 3 year old otherwise healthy girl with a fever..."
 "My patient is a 20 year old G3P2 at 26 weeks with vaginal bleeding..."
 "I'm taking care of a 21 year old male with fever and abdominal pain..."
Background: pertinent and brief information related to the situation
 "The labs are normal and CXR shows no infiltrate but her pulse is elevated..."
 "I have performed a sterile speculum exam and there is frank blood in the vault..."
 "The patient's CT show appendicitis and the patient is vomiting all intake..."
Assessment: analysis and consideration of options, what you found/think
 "I think she needs a fluid bolus but I am wondering if she also needs a UA..."
 "I think this patient might have an active abruption..."
 "I think this patient has appendicitis and needs to be transferred to ANMC..."
Recommendation: action requested, what you want
 "I want your opinion on how much fluid and the need for a UA..."
 "I want you to come in and asses this patient in person..."
 "I would like to transfer this patient via medevac to ANMC..."

NOTE:
 If there is a disagreement regarding the management of a patient between the consultant and the primary provider, the primary provider will advise the consultant as to the reason for the disagreement. If a consensus cannot be reached, a third opinion shall be obtained. This can either be from a YK based provider or from a provider from another facility. At any time the Clinical Director on call can also be notified.

Colon Cancer Screening

MSEC Approved 12/14/16

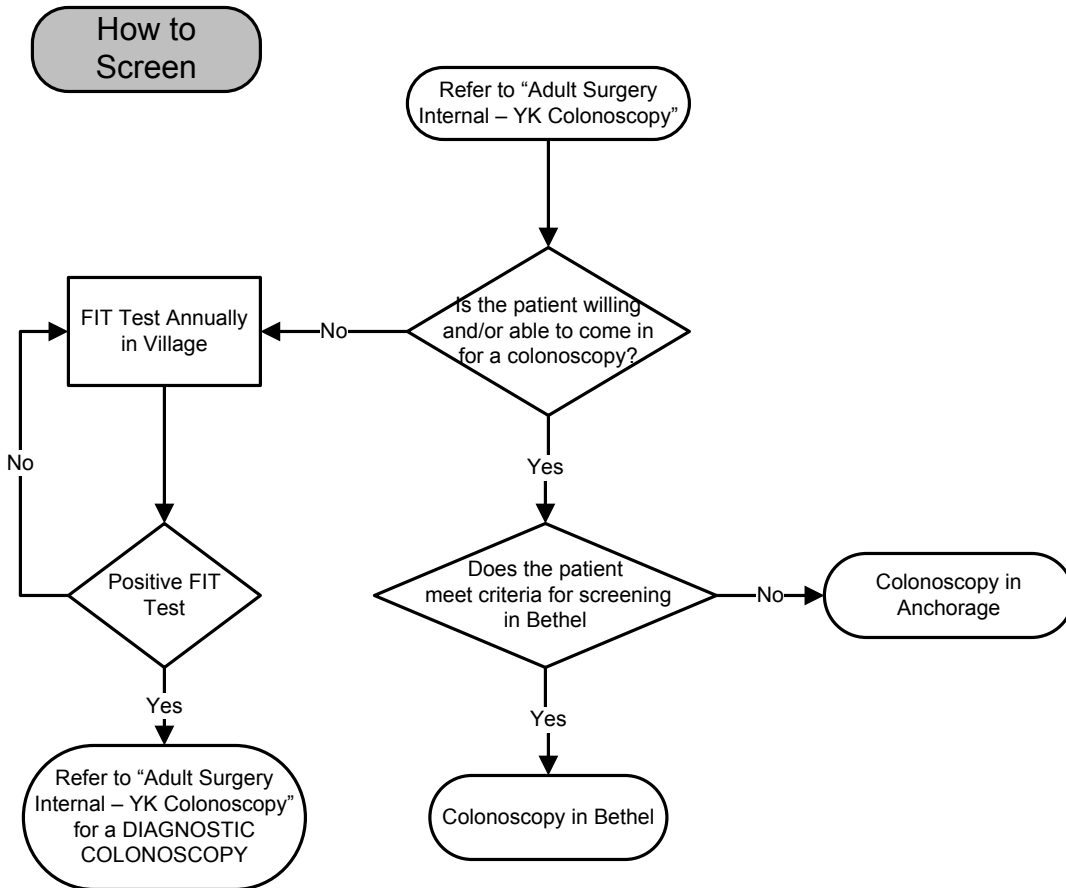
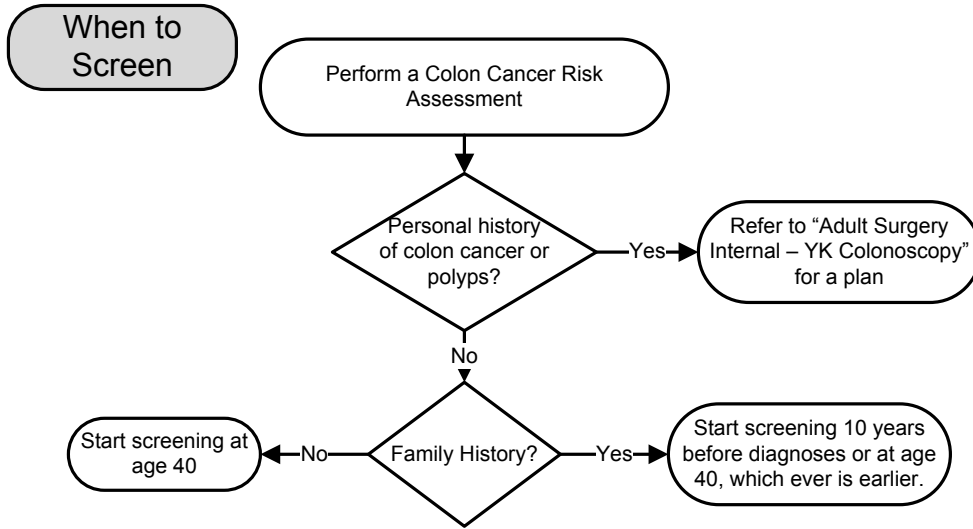

Contraception – Quick Start

3/25/13

This guideline is designed to establish a standard for starting contraception in all cases.

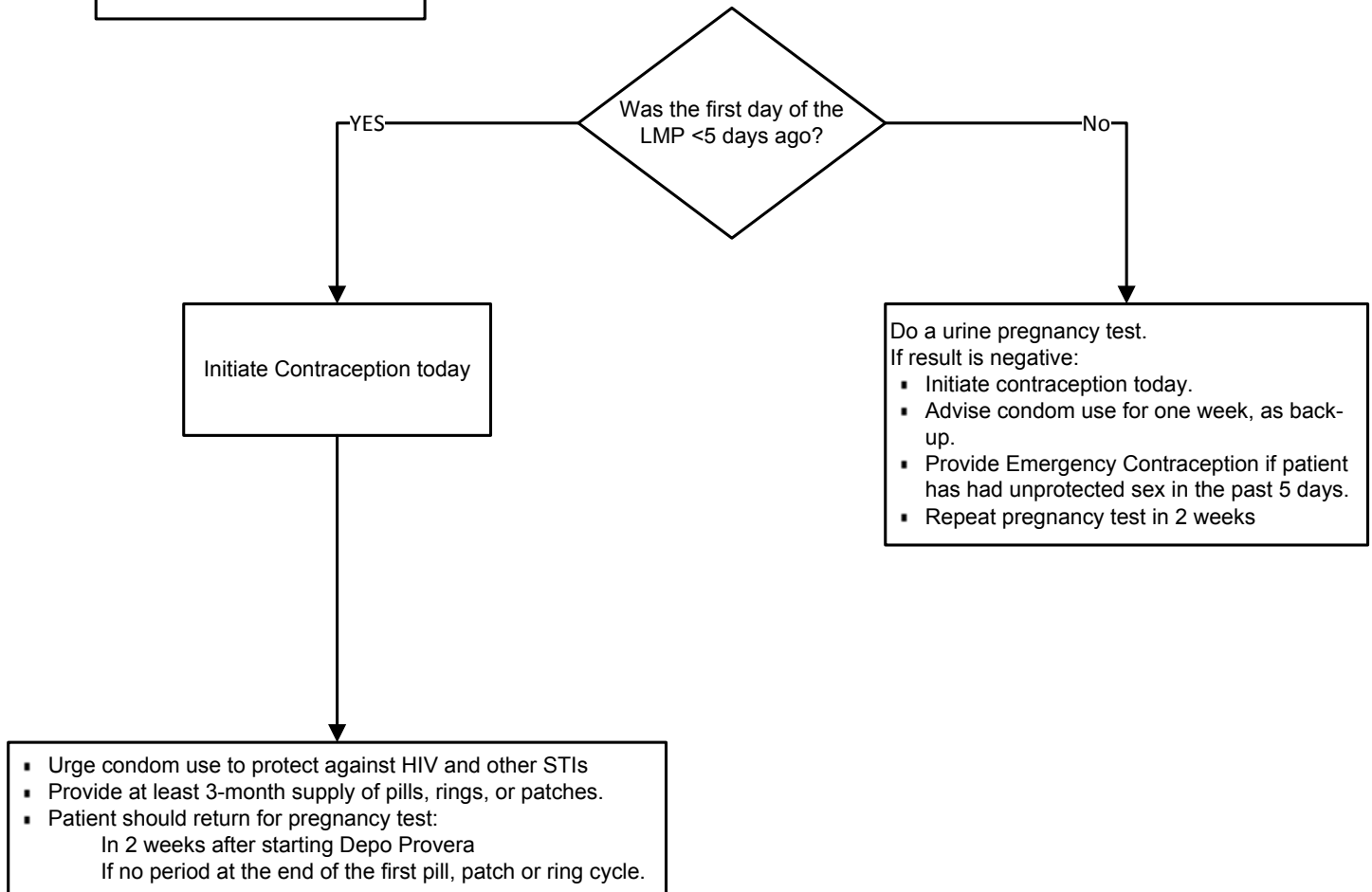

Chronic Pain – Narcotic Treatment Eligibility

MSEC Approved 1/ 21/15

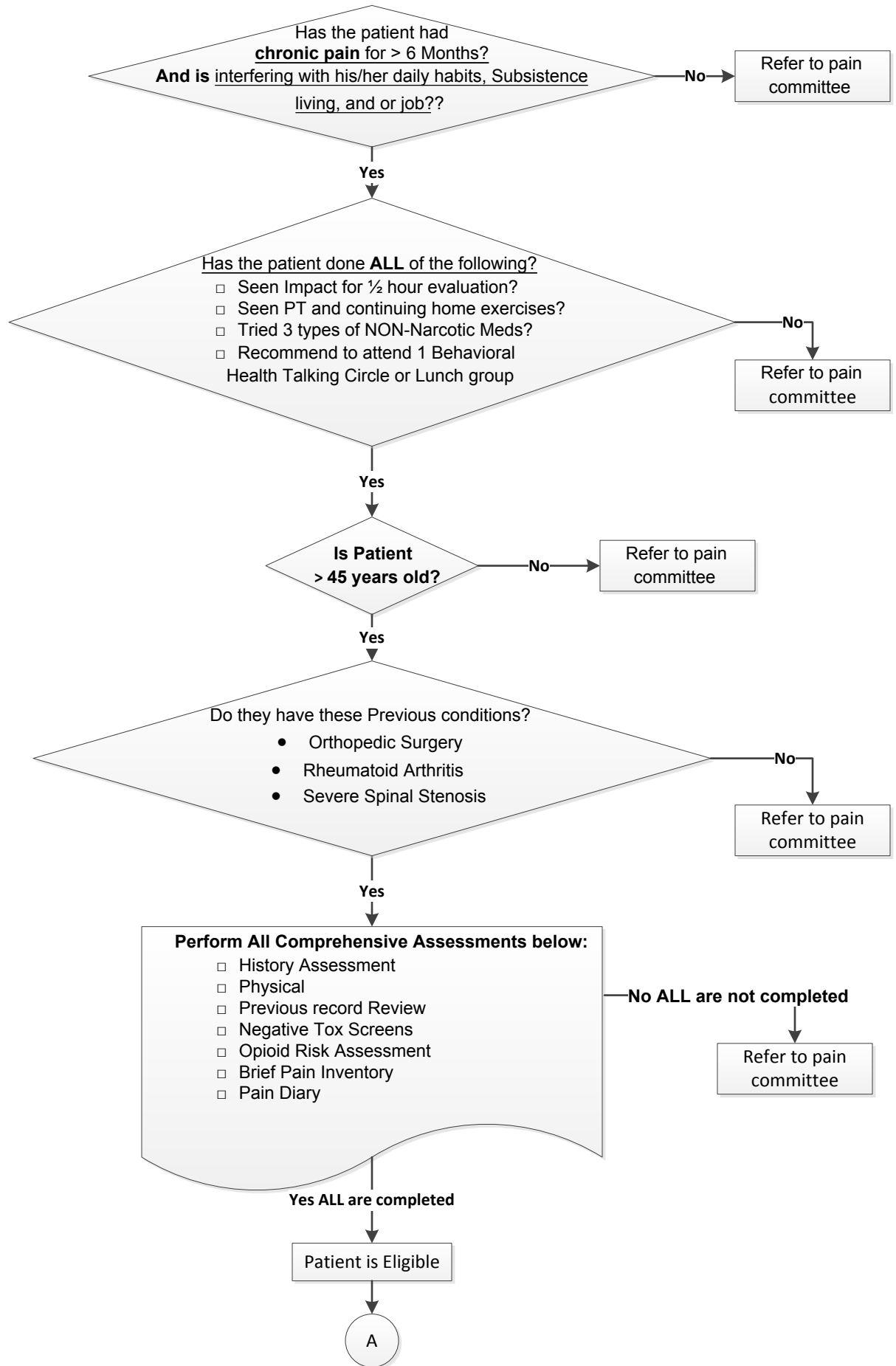

Chronic Pain – Non Narcotics Treatment p.1

MSEC Approved 1/ 21/15

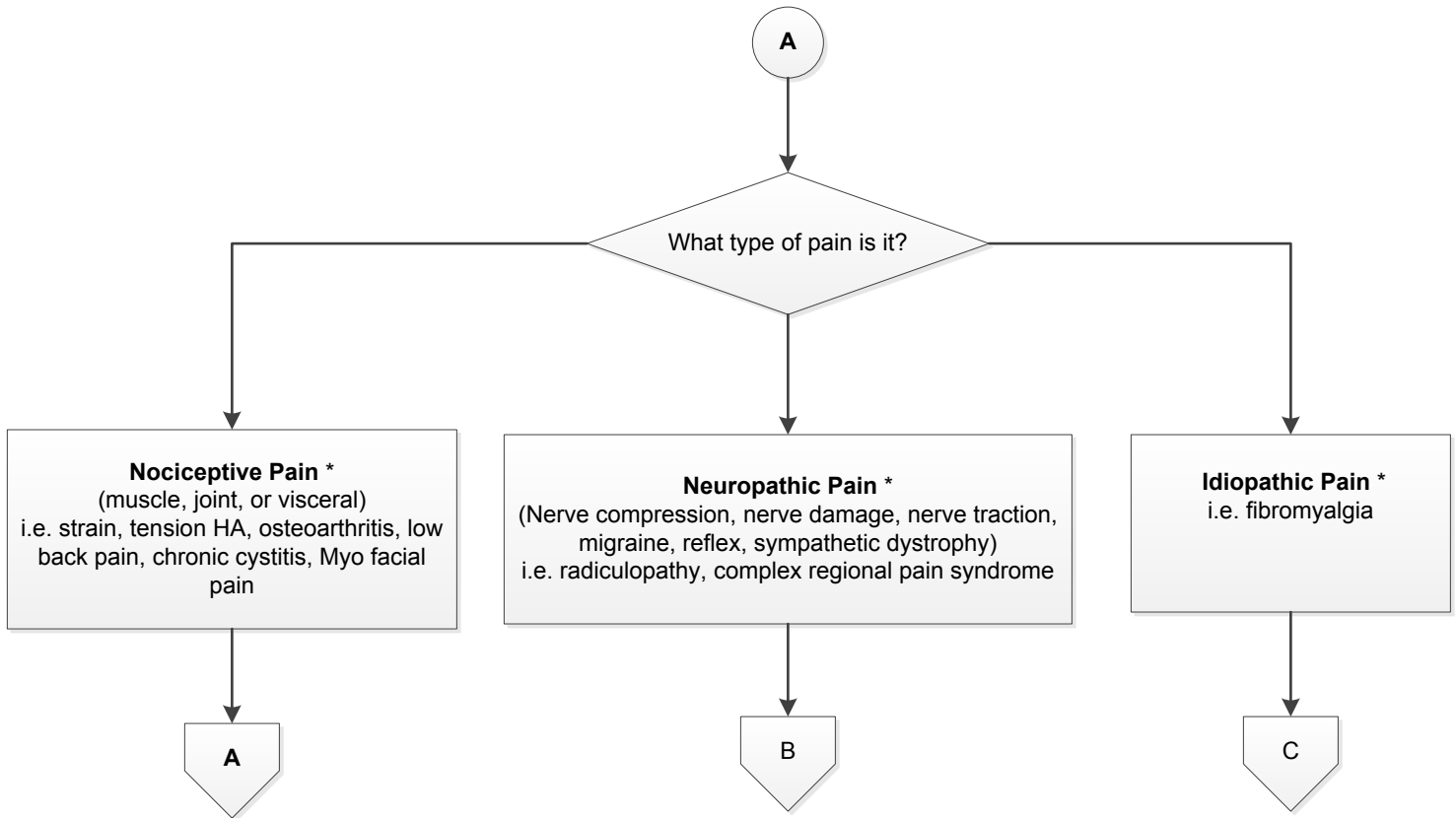

***Treatment Options for all types of pain:**
Sleep Hygiene, Yoga, Meditation

Chronic Pain – Non Narcotics Treatment p.2

MSEC Approved 1/ 21/15

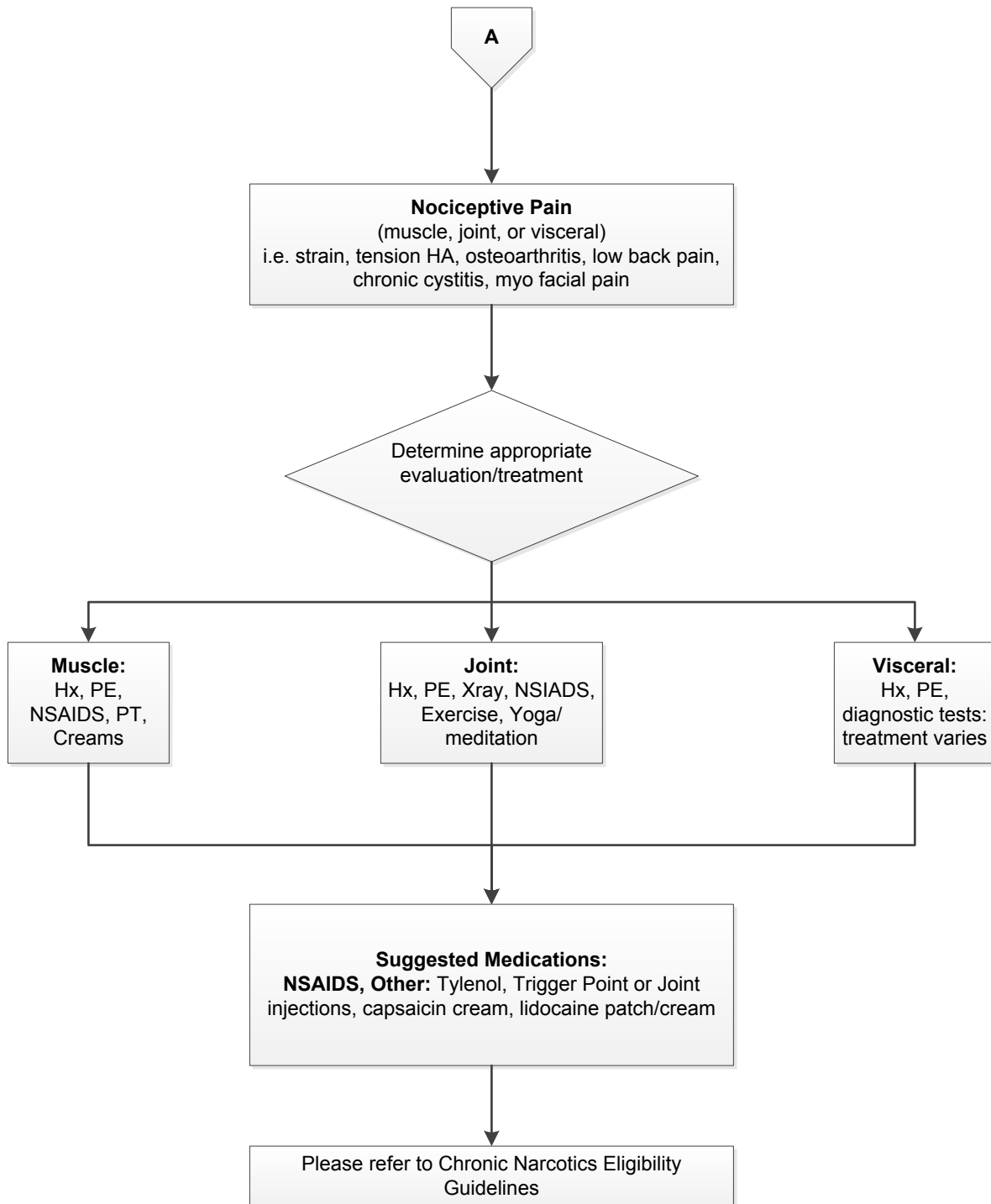

Chronic Pain – Non Narcotics Treatment p.3

MSEC Approved 1/ 21/15

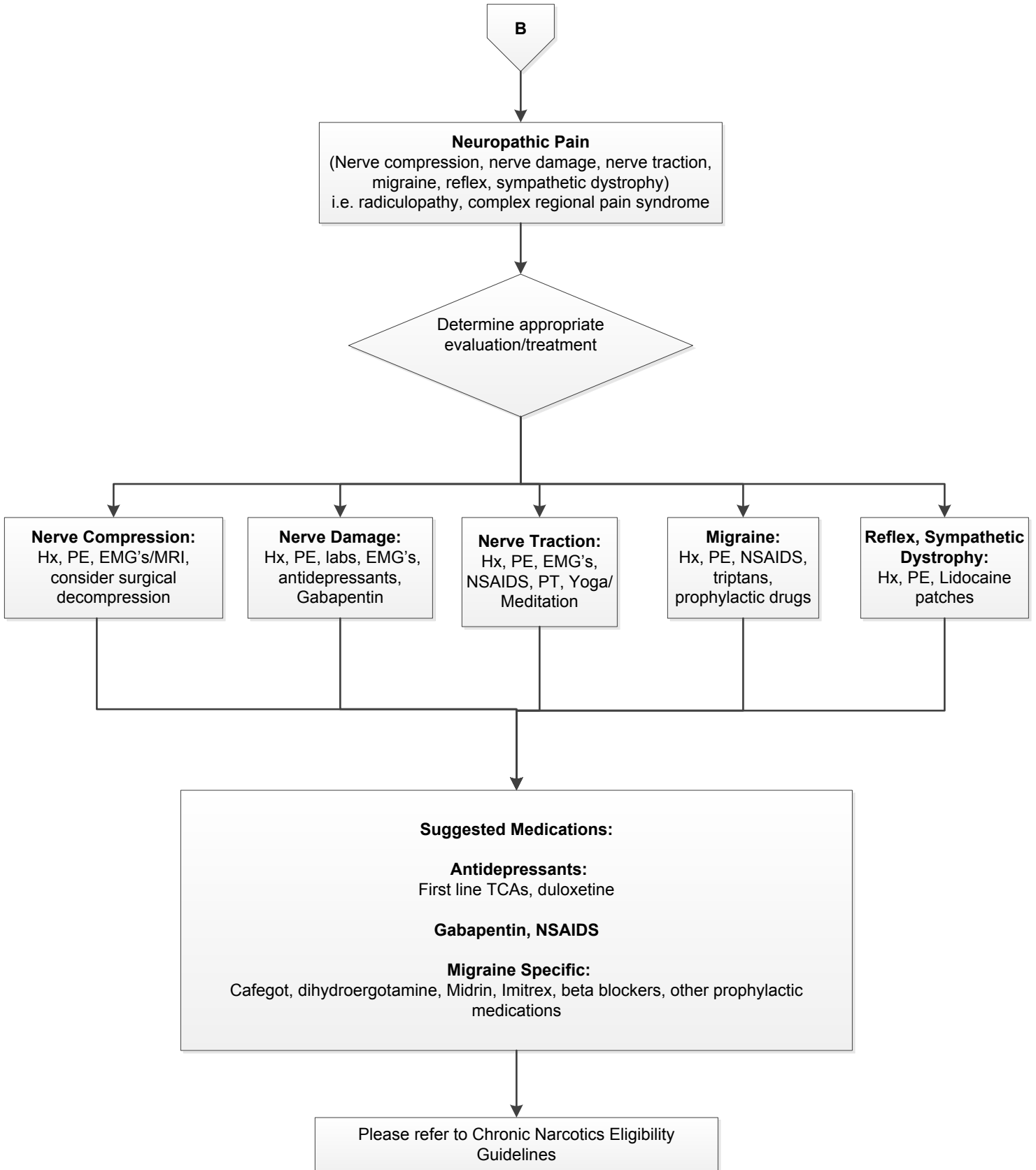

Chronic Pain – Non Narcotics Treatment p.4

MSEC Approved 1/ 21/15

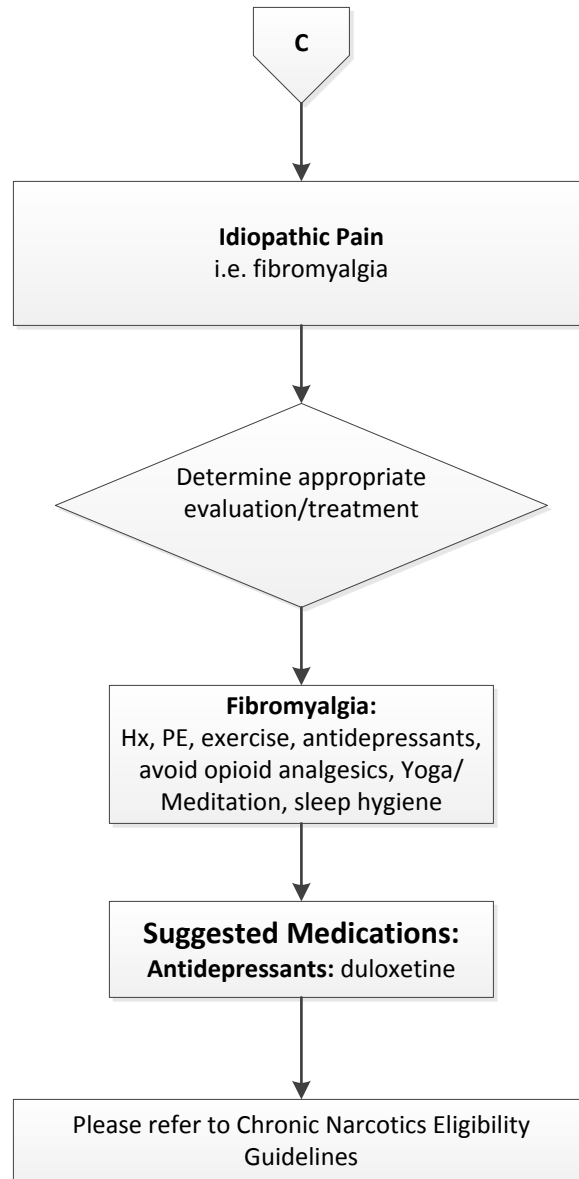

Chronic Pain – Reassessment & Follow-Up

MSEC Approved 1/ 21/15

Follow up and reevaluation: Assess for:

1. functionality
2. adverse effects
3. achievement of goals
4. analgesia
5. behaviors of concern: see flow sheet

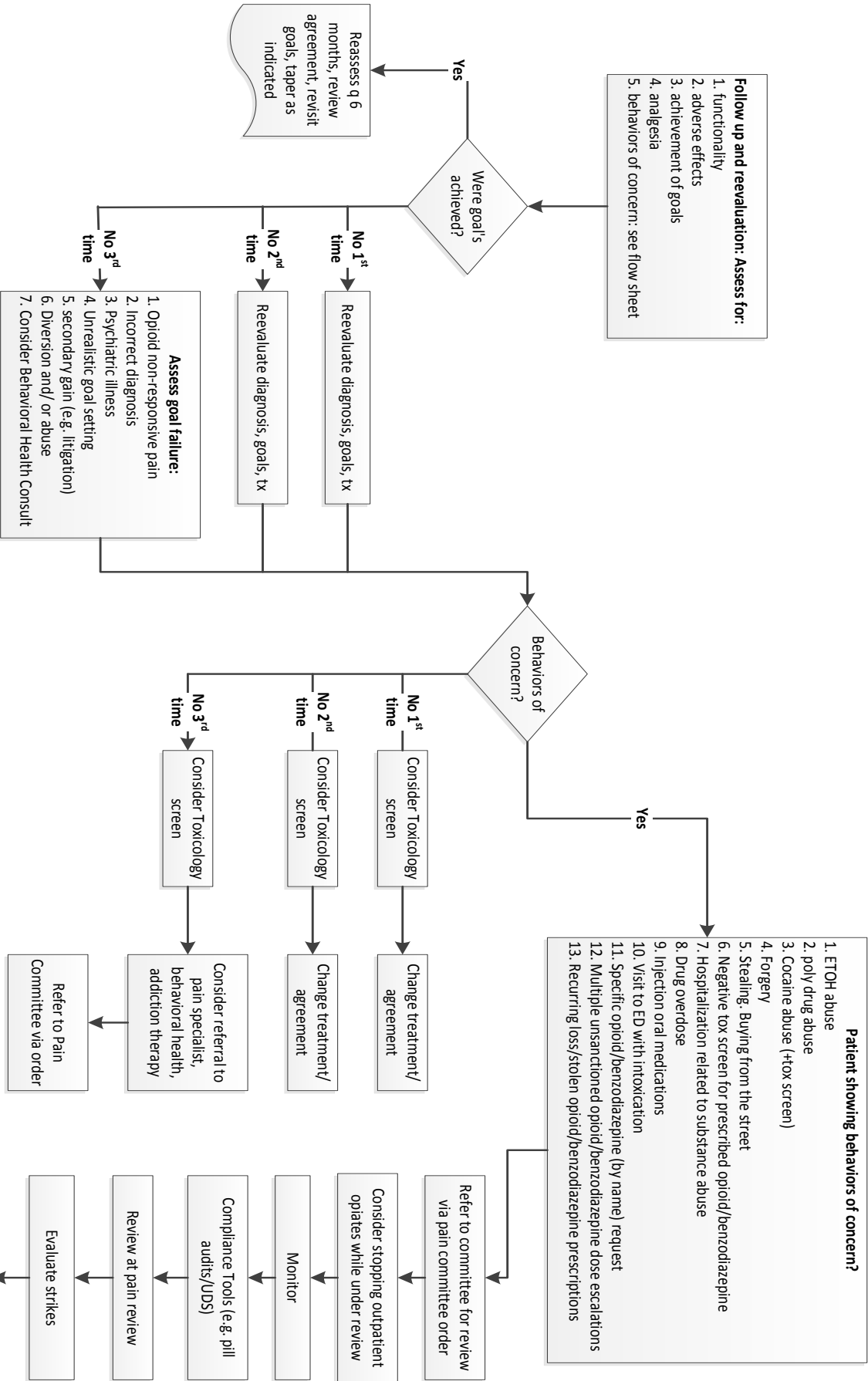

For terminal cancer patients (with life expectancy less than or equal to 6 months) who have previously demonstrated good compliance with Chronic Medication agreement, documentation of titration for pain control as appropriate is acceptable without requiring new agreement. Continue to monitor for achievement of goals/ behaviors of concern

This guideline is designed for the general use of most patients, but may need to be adapted to meet special needs of a specific patient as determined by the patient's medical practitioner

Cervical Cancer Screening Protocol

Coming Soon

Pre-Anesthesia Testing, p.1

2015

AGE	Hb/Hct	Coags	Lytes	Bun/Cr	Gluc	LFT's	EKG	CXR
0 - 59	No routine testing needed in this age group.							
> 60							X	
75 - 99	X		X	X	X		X	

DISEASE	Hb/Hct	Coags	Lytes	Bun/Cr	Gluc	LFT's	EKG	CXR	T&S
Hypertension			X				X		
Card - Mod	X		X	X			X		
Card - Severe	X		X	X			X	X	
Pulm - Mild									
Pulm - Severe	X						X	X	
Smoke > 20yr	X								
Malignancy	X								
Lymphoma								X	
Heptic	X	X	X			X			
Renal	X	X	X	X					
Bleeding	X(cbc)	X							
Diabetes			X	X	X		X		
Expected Blood Loss	X								X

MEDICATION	Hb/Hct	Coags	Lytes	Bun/Cr	Gluc	LFT's	EKG	CXR
Diuretic			X	X				
BP Meds			X	X			X	
Cardiac Meds			X	X			X	
Steroids			X		X			
Anticoagulants	X	X						

Other

Urine HCG: Needed within 48 hours of surgery in women of childbearing age (13–50).

Drug Levels: Level drawn on all patients on Digoxin and Dilantin.

CXR: Recent change in sputum quality or color, pneumonia in past 3 months, chronic home O2 use, planned intrathoracic surgery, or if exam reveals rales, rhonchi, or wheezes

Surgical Risk Screening Protocol Orders

1. Patients who are not to be scheduled at YKHC:
 - a. Patients with BMI > 45 (Up to BMI of 45 is acceptable if no significant, unstable CV, respiratory, or endocrine Pathology is present)
 - English BMI Formula = (Weight in pounds / (Height in inches) x (Height in inches)) x 703
 - Metric BMI Formula = (Weight in Kilograms / (Height in Meters) x (Height in Meters))
 - b. Obstructive Sleep Apnea Perioperative Risk Score of 5 or 6.
2. Preventive antibiotic therapy will be administered within one hour prior to skin incision per protocol pre-operatively, based on procedure type and patients allergies, unless otherwise ordered by physician.
3. DVT/VTE prevention methods will be implemented using SCIP Mechanical Prophylaxis Protocol unless contraindicated or otherwise documented in orders by physician.

Diabetes Management

1. Discontinue all oral agents the evening prior to surgery, except Metformin which can be taken the evening prior to surgery but not to day of surgery.
2. Discontinue insulin after midnight for AM surgeries.
3. Take 1/2 usual dose of insulin the AM of surgery if surgery is scheduled to start at noon or later.
4. Take 100% of Lantus insulin up to time of surgery.
5. Consume apple or cranberry juice up till 2 hours prior to arrival to surgery if insulin was used.
6. For insulin pumps, set to basal rate and continue throughout pre-operative period.
7. Arrival to Holding Area, Glucose will be obtained. Results treated by anesthesia.

continued on next page.

Pre-Anesthesia Testing, p.2

2015

NPO Guidelines:

The pre-operative nurse will instruct all patients to be NPO after midnight and to follow the surgeon's instructions if they differ from these.

The surgeon who gives different instructions will be responsible for thorough patient instruction of anything other than these guidelines.

1. All patients are equal with regard to NPO guidelines (i.e. gastric emptying time, obesity)
2. Clear liquids may be consumed up to 2 hours prior to scheduled arrival time.
3. Clear liquids are water, black coffee, and beverages not cloudy and can be seen through. Sugar and artificial sweeteners are acceptable. All broths are NOT acceptable.
4. Patient may brush their teeth, but should not swallow tooth paste.
5. Gum and candy of any type are not allowed.
6. All patients will be allowed to eat a full, regular diet (solid) up to 8 hours prior to surgery. Patient going to the OR at 0730 who were NPO after midnight are considered to meet this standard.
7. Infants up to 24 months of age will be allowed breast milk up to 4 hours prior to the arrival to the hospital. Infant formula will be considered a solid.

Table 4. Estimated Energy Requirements for Various Activities, Based on Duke Activity Status Index*

1 MET	Can you...	
		take care of yourself?
		eat, dress, or use the toilet?"
		walk indoors around the house?
		walk 1 or 2 blocks on level ground at 2-3 mph (3.2 - 4.8 KPH)?
<4 METs	Can you...	
		do light work around the house, such as dusting or washing dishes?
≥4 METs	Can you...	
		climb a flight of stairs or walk up a hill?
		walk on level ground at 4 mph (6.4 kph)?
		run a short distance?
		do heavy work around the house, such as scrubbing floors or lifting or moving furniture?
		participate in moderate recreational activities, such as golf, bowling, dancing, doubles tennis, or throwing a baseball or football?
≥10 METs	Can you...	
		participate in strenuous sports, such as swimming, singles tennis, football, basketball, or skiing?
* MET = metabolic equivalent.		
Adapted from J AM Coll Cardiol, with permission from Elsevier.		